

THB.387.A4A

TeePlug 4 pole Screw terminal 7mm to 12mm cable diameter, 4 mm max conductor size IP68 17.5A 450V 1 cable entry

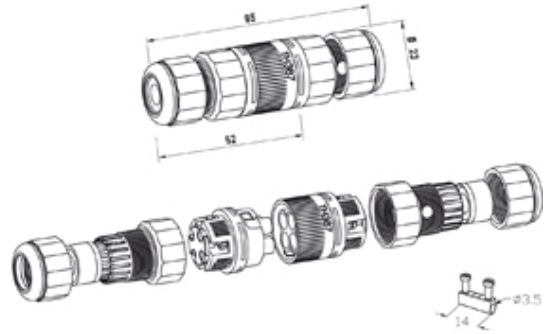

SPECIFICATION

Cable Entries	1
Number of Poles	4
Terminal Type	Screw
Body Material	PA66
Max Conductor Size (Sq mm)	4
Max Current (A)	17.5
Max Voltage (V)	450
Minimum Temp Rating °C	-40
IP Rating	68
Max Temp Rating °C	125
Fixing System	Cable
Maximum Cable Diameter (mm)	12
Minimum Cable Diameter (mm)	7
Temperature "T" Rating	T125