

INLINE Flow sensor for hazardous area II 1 G/D - II 2 D - II 3 GD - I M1

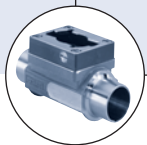

Type SE30 Ex can be combined with...



Type S030

INLINE fitting with PVDF paddle-wheel

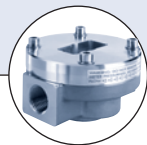

Type S070

Positive displacement flow fitting



Type 8025

Universal flow transmitter remote version

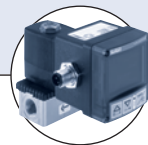

Type 8623-2 on 6022

PI flow controller on Solenoid valve

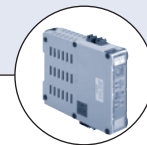

Intrinsic safety barrier

with NAMUR input

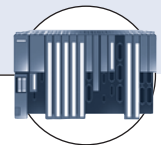

PLC

with NAMUR input

- Flow meter with NAMUR or NPN/PNP output signal
- Mounting, dismounting of electronics by a Quarter-Turn
- Protection- Ex : intrinsic safety approvals for use in Zone:
 - 0, 1, 2 - Gas (G)
 - 20, 21, 22 - Dust (D)
 - M1, M2

The intrinsic safety flow sensor SE30 Ex for continuous flow measurement is especially designed for use in neutral, slightly aggressive, solid-free liquids, in hazardous environments.

The flow sensor SE30 Ex is made up of an electronic module and a measuring element, either a fitting S030 or a fitting S070, quickly and easily connected together by a Quarter-Turn.

The sensor detects the paddle-wheel or oval gear rotation, modulates the current of the power supply line according to NAMUR standard or produces an NPN/PNP output signal (depends on model). To operate the NAMUR signal, an intrinsic safety interface should be connected to the sensor SE30 Ex.

The connection to an other device in the safe area depends on the used flowmeter model.

General data	
Compatibility^{1a)}	with fittings S030 or S070 (see corresp. datasheet)
Materials	
Housing, cover	PC (NPN/PNP version); PPS (NAMUR version) glass fibre reinforced
Cable plug	PA, with silicone gasket
Materials wetted parts	Fitting using restriction see "SAFETY INSTRUCTIONS - NOTICE OF ATEX INSTRUCTIONS"
Fitting S030 ^{1a)}	
Body	Brass, Stainless steel, PVDF
Paddle-wheel	PVDF (only)
Axis and bearings	Ceramics
Seal	FKM
Fitting S070 ^{1a)}	
Body	Aluminium, Stainless steel
Rotor	PPS, Aluminium, Stainless steel
Shaft	Stainless steel
Seal	FKM (EPDM or PTFE on request)
Electrical connection	Cable plug EN 175301-803 (supplied)
Voltage supply cable	between 0.5 and 1.5 mm ² cross section; max. 50 m length, shielded
Electrical data	
Power supply^{1b)}	8-15 VDC (NAMUR version) 12-36 VDC (NPN/PNP version)
Current consumption (with sensor)	max. 7 mA (NAMUR vers.); 30 mA (NPN/PNP vers.)
Output	Depends on the device model and application area: - 2-wire current modulation according to Namur (250 Hz max.) - NPN/PNP (100 mA max., 250 Hz max.)
Reversed polarity (of DC)	Protected

1. Refer to the rubric "SAFETY INSTRUCTIONS - NOTICE OF ATEX INSTRUCTIONS"

a) to choose the appropriate fitting for the area of application

b) to choose the supply adapted to the area of application

Complete device data (fitting + electronic module)

Pipe diameter	DN 6 to 100 (depends on the fitting model)
Measuring range S030 fitting S070 fitting	0.3 m/s to 10 m/s ; 0.5 l/min to 1000 l/min 2 to 1200 l/min (viscosity >5 cps) 3 to 616 l/min (viscosity <5 cps)
Medium temperature max.	80 °C
Fluid pressure max. S030 fitting S070 fitting	PN10 (PVDF), PN16 (stainless steel, brass) PN55 (PN10 for flange version)
Viscosity S030 fitting S070 fitting	300 cps. max 1000 cps. max (higher on request)
Accuracy Fitting S030 + sensor SE30Ex Teach-In (via remote transmitter 8025) Standard K-factor Fitting S070 + sensor SE30Ex	 ≤ ±0.5% of F.S.* (at 10 m/s) ≤ ±(0.5% of F.S. + 2.5% of Reading)* ≤ ±0.5% of Reading
Linearity	≤ ±0.5% of F.S.* (at 10 m/s)
Repeatability S030 fitting S070 fitting	0.4% of Reading* 0.3% of Reading*

Environment

Ambient temperature	-15 °C up to + 60 °C (operating and storage)
Relative humidity	≤ 80%, non condensated

Standards and approvals

Protection class	IP67 with connector plugged-in and tightened acc. to EN 60529
Standards ATEX	EN 50014 (1997) EN 50020 (2002) EN 50021 EN 50281-1-1 (1998)
EMC	EN 61000-6-3 (2001) EN 61000-6-2 (2001)
NAMUR	EN 60947-5-6

* Under reference conditions i.e. measuring fluid=water, ambient and water temperatures=20 °C, applying the minimum inlet and outlet pipe straights, matched inside pipe dimensions.

F.S.=Full scale (10 m/s)

Accuracy diagram

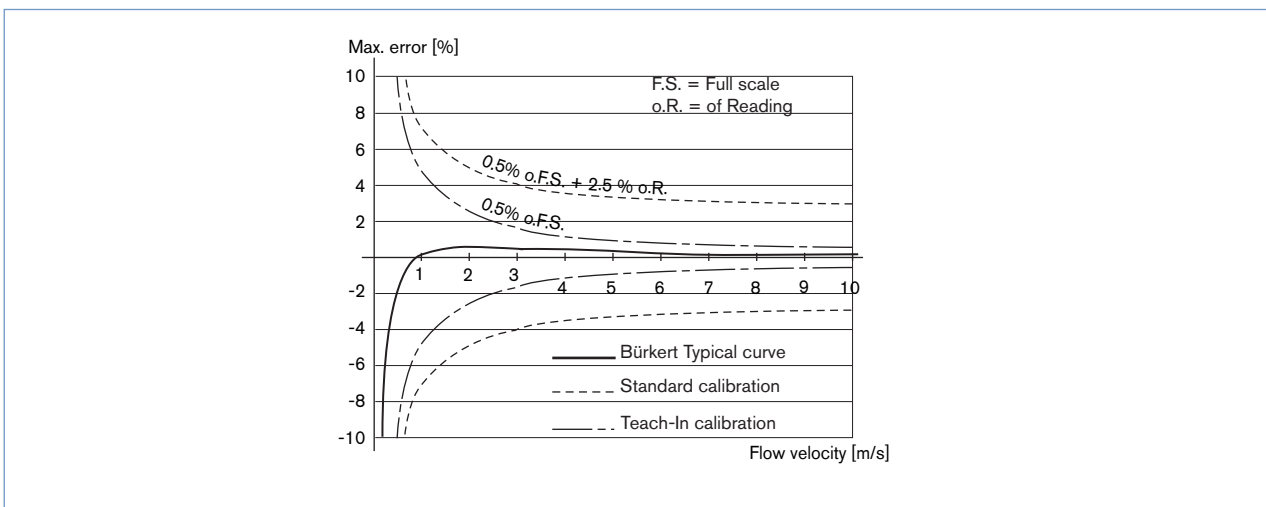

Installation into S030 fitting

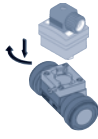

The flow sensor SE30 Ex can easily be installed into any Bürkert INLINE fitting system S030 with integrated PVDF paddle-wheel. The minimum straight upstream and downstream distances must be observed. According to pipe's design, necessary distances can be bigger or a flow conditioner can be used to obtain the best accuracy.

For more information, please refer to EN ISO 5167-1.

EN ISO 5167-1 prescribes the straight inlet and outlet distances that must be complied with when installing fittings in pipe lines in order to achieve calm flow conditions. The most important layouts that could lead to turbulence in the flow are shown on the left, together with the associated prescribed minimum inlet and outlet distances. These ensure calm, problem-free measurement conditions at the measurement point.

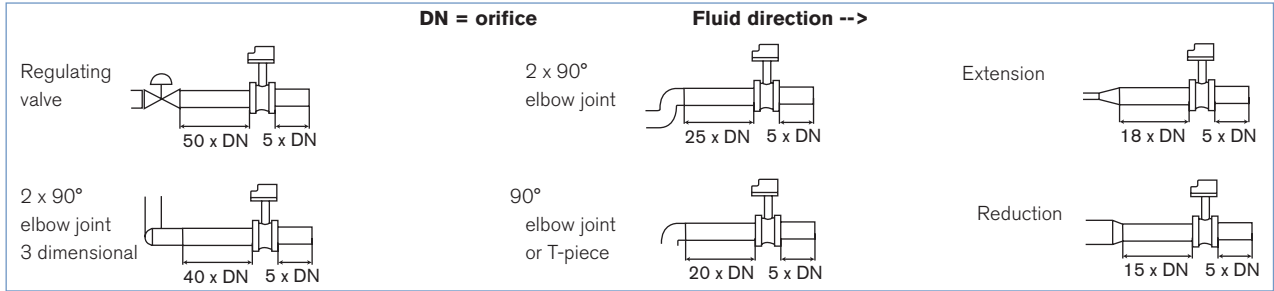

The flow rate sensor can be installed into either horizontal or vertical pipes.

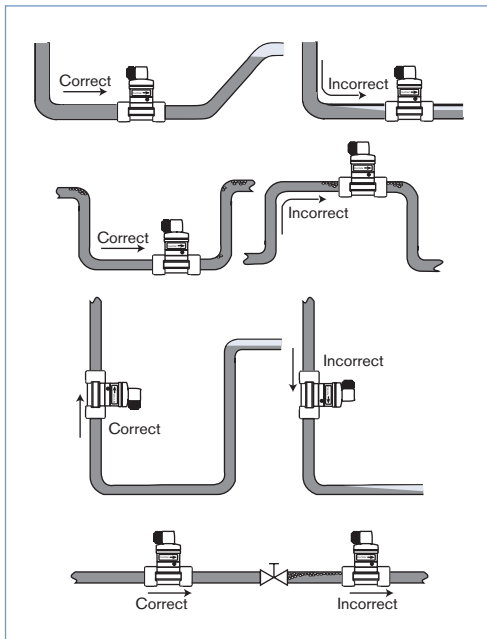

Pressure and temperature ratings must be respected according to the selected fitting material. The suitable pipe size is selected using the diagram Flow / Velocity / DN.

The sensor is not designed for gas flow measurement.

Selection of fitting / pipe size

Example:

- Specification of nominal flow: 10 m³/h
- Ideal flow velocity: 2...3 m/s
- For these specifications, the diagram indicates a pipe size of DN40

Flow rate

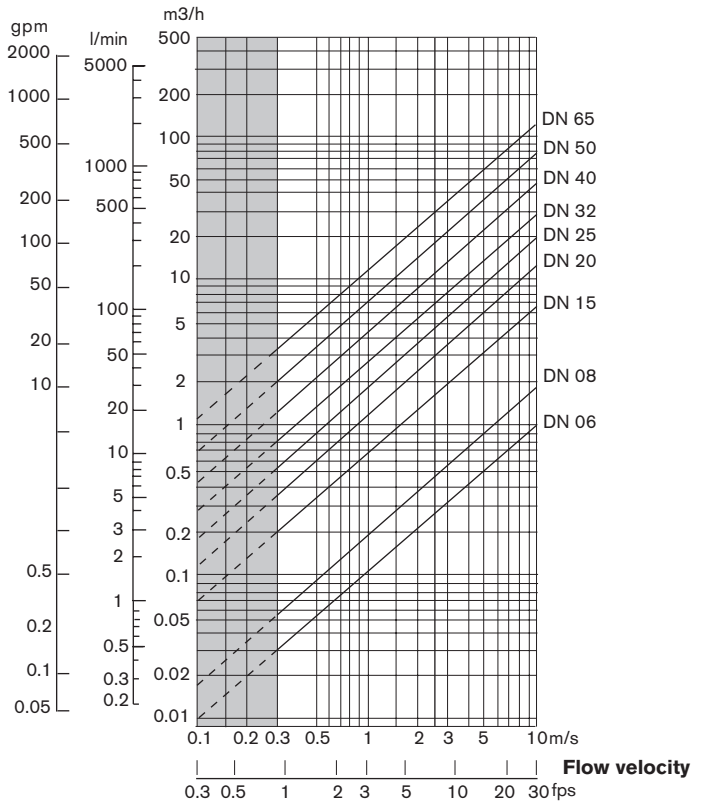

Installation into S070 fitting

The fitting can handle particle sizes up to 250 µm. To prevent damage or locking from dirt or foreign matter, we strongly recommend the installation of a 250 µm (60 mesh) strainer as close as possible to the inlet side of the sensor.

The pipe must be filled with liquid and free from air bubbles. Avoid air purge of the system.

Ensure the fitting is installed so that the rotor shafts are always in an horizontal plane. Flow direction is marked by an arrow on the body.

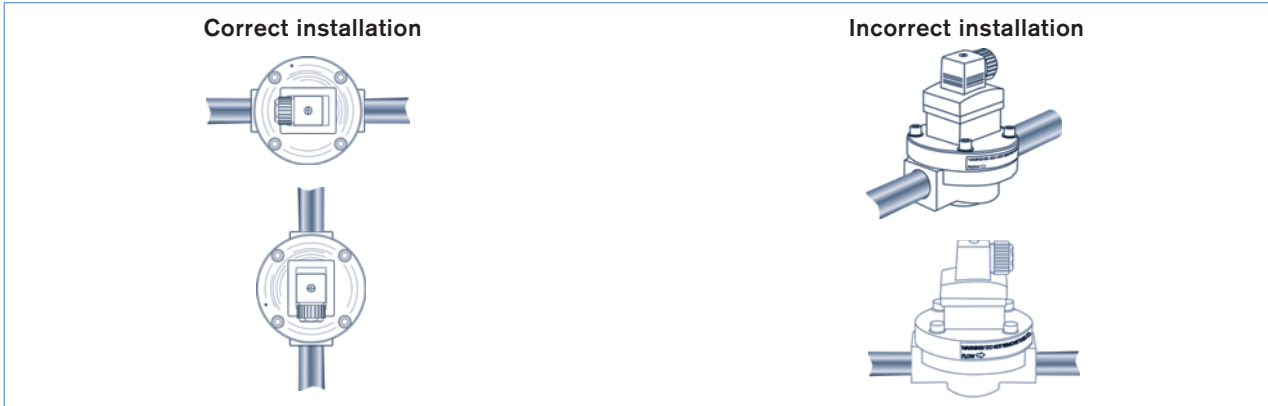

Design

The flow sensor consists of an electronic module SE30 Ex associated to a fitting S030 or S070 respectively with integrated measurement paddle-wheel or oval gear. This connection is made by means of a Quarter-Turn.







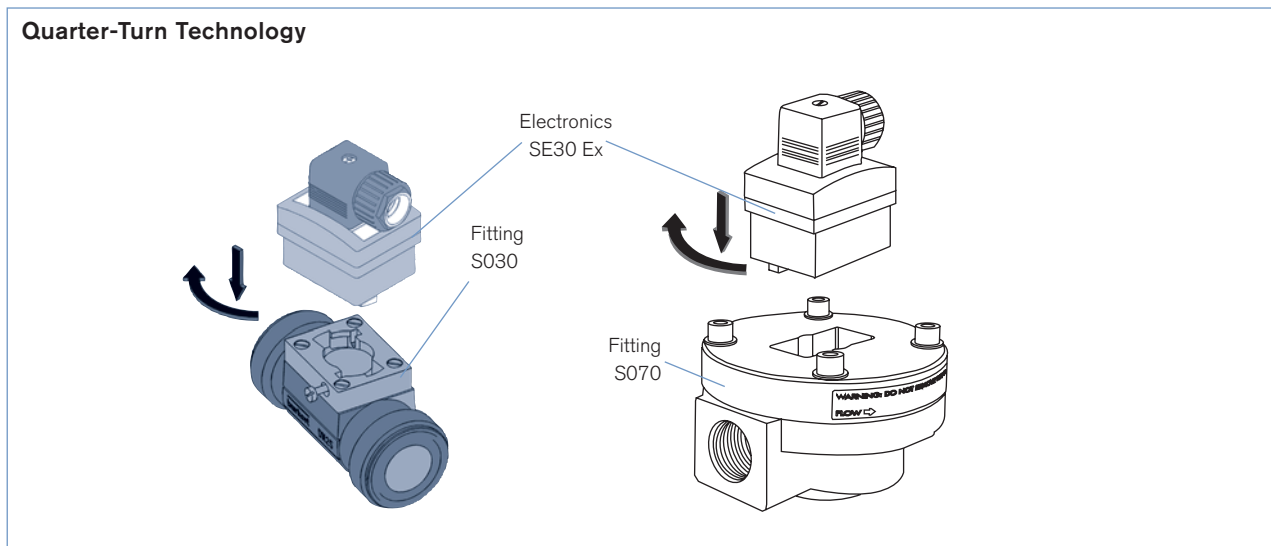





When liquid flows through the pipe, the fitting paddle-wheel or oval gear is set in rotation modulating the current of the power supply line according to NAMUR standard. The modulated frequency of this signal is proportional to the flow.

This signal is converted, by the connected type NAMUR intrinsic safety barrier, into a frequency signal on its open collector output.

The electrical connection of the sensor is made via a cable plug EN 175301-803 (Type 2508).



Overview of hazardous areas depending on SE30 Ex flow sensor models (according to ATEX)

	Equipment for explosive atmospheres (surfaces) - GROUP II					
	Very high level of protection		High level of protection		Normal level of protection	
	Gas Zone 0 Explosive atmospheres present continuously, long periods or frequently	Dust Zone 20 Explosive atmospheres present continuously, long periods or frequently	Gas Zone 1 Explosive atmospheres are likely to occur	Dust Zone 21 Explosive atmospheres are likely to occur	Gas Zone 2 Explosive atmospheres are unlikely to occur or present only infrequently and for a short period only	Dust Zone 22 Explosive atmospheres are unlikely to occur or present only infrequently and for a short period only
<p>This equipment can be installed in some potentially explosive atmospheres (surface industries or mining depending on the model) and is in compliance with the 94/9/CE directives.</p>						
<p>CATEGORY 1</p> <p>SE30 Ex - Namur II 1 G/D (Item no. 552 901)</p> <p>EEx ia IIC T6 - IP6X T80 °C associated with PVDF, brass, stainless steel or aluminium fittings</p>	<p>to use with intrinsic safety barrier with Namur input*</p> 	<p>to use with intrinsic safety barrier with Namur input*</p> 	<p>to use with intrinsic safety barrier with Namur input*</p> 	<p>to use with intrinsic safety barrier with Namur input*</p> 	<p>to use with intrinsic safety barrier with Namur input*</p> 	<p>to use with intrinsic safety barrier with Namur input*</p> 
<p>CATEGORY 2</p> <p>SE30 Ex - Namur II 2 D (Item no. 553 454)</p> <p>IP6X T80 °C associated with PVDF, brass, stainless steel or aluminium fittings</p>	<p>Not to be used</p>	<p>Not to be used</p>	<p>Not to be used</p>	<p>to use with Namur input*</p>  or an 8-15 V supply source	<p>Not to be used</p>	<p>to use with Namur input*</p>  or an 8-15 V supply source
<p>CATEGORY 3</p> <p>SE30 Ex - II 3 GD - NPN/PNP (Item no. 552 353)</p> <p>EEx nA II T4 - IP6X T135 °C associated with PVDF, brass, stainless steel or aluminium fittings</p>	<p>Not to be used</p>	<p>Not to be used</p>	<p>Not to be used</p>	<p>Not to be used</p>	<p>to use with a 12-36 V supply source</p>	<p>to use with a 12-36 V supply source</p>
	Equipment for explosive atmospheres (Firedamp mines) - GROUP I					
	Firedamp mines zone M1 Very high level of protection			Firedamp mines zone M2 High level of protection		
<p>CATEGORY 1</p> <p>SE30 Ex - Namur I M1 (Item no. 553 455)</p> <p>EEx ia T80 °C only associated with brass or stainless steel fittings</p>	<p>to use with intrinsic safety interface with Namur input*</p>  and with a mechanical protection cover 			<p>to use with intrinsic safety interface with Namur input*</p>  and with a mechanical protection cover 		

Note * The open circuit voltage for the NAMUR input must be included between 8 and 15 V.

DTS 1000049988 EN Version: E Status: RL (released | freigegeben | validé) printed: 30.06.2006

Safety orders - Notice of ATEX instructions

The appropriate SE30 Ex model is function of the installation environment.

Model SE30 Ex Namur (Item no. 552 901) Group II - Category 1 for potentially explosive zones of gas (0, 1 and 2) and dust (20, 21 and 22)

• ATEX marking meaning and ATEX installation zones

CE 0102  II 1 G/D
 EEx ia IIC T6 -IP6X T80 °C
 ambient T: -15 °C ≤ Ta ≤ 60 °C
 LCIE 04 ATEX 6070 X

• Special conditions for a safe use

The device is an intrinsic safety certified material according to EN 50020. It may be installed in potentially explosive atmospheres: zones 0, 1 or 2 and zones 20, 21 or 22.

The connector can only be connected to certified intrinsic safety equipment.
 This combination must be compatible with intrinsic safety rules (see electrical safety data in the table under the connection diagram opposite).

The ambient temperature of use must always be between these limits: from -15 °C to +60 °C.

Compatible mechanical assembly and fluid connections:

**Use PVDF, brass, stainless steel or aluminium fitting only.
 Any other connection is prohibited.**

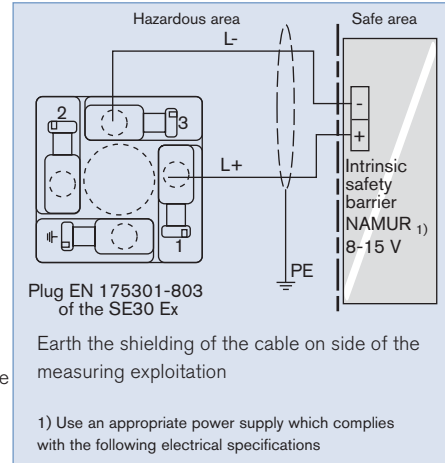

Electrical safety data	
Ui (V)	≤ 15 V
Ii (mA)	≤ 50 mA
Pi (mW)	≤ 188 mW
Ci	≤ 1.2 nF
Li	≅ 0

Model SE30 Ex Namur (Item no. 553 454) Group II - Category 2 for potentially explosive zones of dust (21 and 22)

• ATEX marking meaning and ATEX installation zones

CE 0102  II 2 D
 IP6X T80 °C
 ambient T: -15 °C ≤ Ta ≤ 60 °C
 LCIE 04 ATEX 6070 X

• Special conditions for a safe use

The device is an intrinsic safety certified material according to EN 50281-1-1. It may be installed in potentially explosive atmospheres: zones 21 or 22.

The connector may be connected to an 8 - 15 V supply source. It is preferable to use an appliance that has the intrinsic safety certification (NAMUR type).

The ambient temperature of use must always be between these limits: from -15 °C to +60 °C.

Compatible mechanical assembly and fluid connections:

**Use PVDF, brass, stainless steel or aluminium fitting only.
 Any other connection is prohibited.**

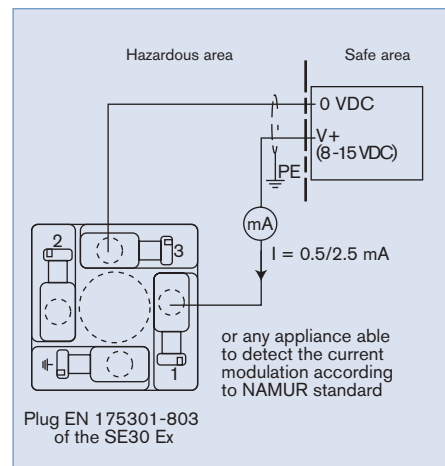

DTS 1000049988 EN Version: E Status: RL (released | freigegeben | validé) printed: 30.06.2006

Safety orders - Notice of ATEX instructions

Model SE30 Ex Namur (Item no. 553 455) Group I - Category 1 for firedamp mines M1

• ATEX marking meaning and ATEX installation zones

CE 0102 I M 1
 EEx ia T80 °C
 ambient T: -15 °C ≤ Ta ≤ 60 °C
 LCIE 04 ATEX 6070 X

• Special conditions for a safe use

The device is an intrinsic safety certified material for firedamp mines according to EN 50020. It may be installed in potentially explosive atmospheres: zone M 1.

The connector can only be connected to certified intrinsic safety equipment. This combination must be compatible with intrinsic safety rules (see electrical safety data in the table under the connection diagram opposite).

The ambient temperature of use must always be between these limits: from -15 °C to +60 °C.

Compatible mechanical assembly and fluid connections:

**Use brass or stainless steel fitting only.
 Any other connection is prohibited.**

The appliance must be protected from a mechanical damage. Mechanical protection with order code 553 519 must be used. This protection is mounted on the sensor by using an appropriate bracket (not included in our delivery).

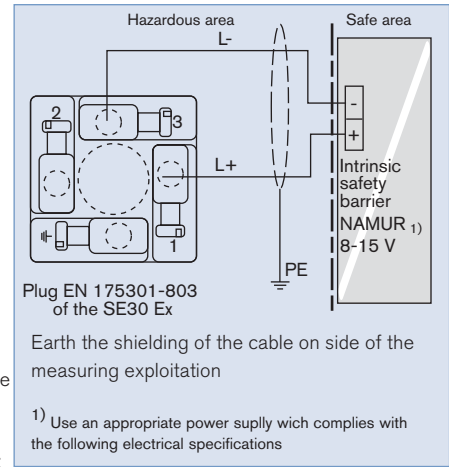

Electrical safety data	
Ui (V)	≤ 15 V
Ii (mA)	≤ 50 mA
Pi (mW)	≤ 188 mW
Ci	≤ 1.2 nF
Li	≅ 0

Model SE30 Ex NPN/PNP (Item no. 552 353) Group II - Category 3 for potentially explosive zones of gas (2) and dust (22)

• ATEX marking meaning and ATEX installation zones

CE 0102 II 3 GD
 EEx nA II T4 -IP6X T135°C
 ambient T: -15 °C ≤ Ta ≤ 60 °C
 INERIS 04 ATEX 3015X

• Special conditions for a safe use

The device is an ATEX certified material according to EN 50021 and EN 50281-1-1. It may be installed in potentially explosive atmospheres: zones 2 or 22.

The connector may be connected to a 12-36 V supply source.

The ambient temperature of use must always be between these limits: from -15 °C to +60 °C.

Compatible mechanical assembly and fluid connections:

PVDF, brass, stainless steel, aluminium fittings can be used. Any other connection is prohibited.

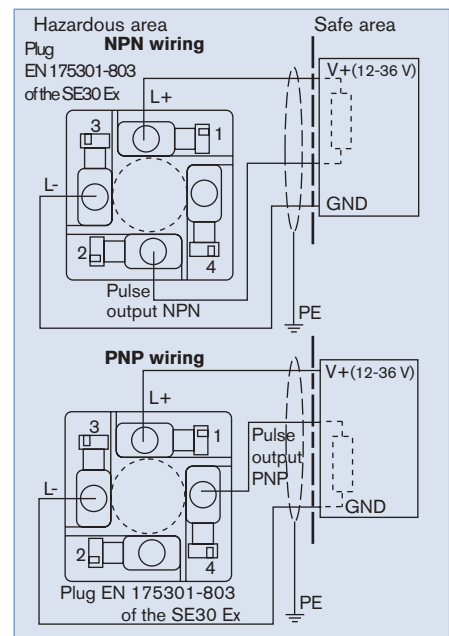

Electrical safety data on power supply line (L+/L-)	
U max.	36 V
I max.	30 mA
P max.	108 mW

Dimensions [mm]

Electronics SE30 Ex

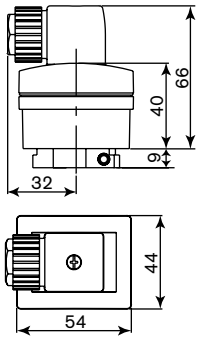

Mounted on S030 fitting

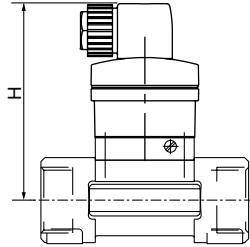

DN	H
06	95.5
08	95.5
15	100.5
20	98.0
25	98.0
32	102.0
40	105.5
50	112.0
65	112.0

Mounted on S070 fitting

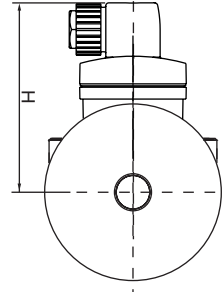

Orifice	H
15*	101
25	116
40	133
50	151
80	191
100	192

* Only with threaded connection

Ordering chart - sensor Type SE30 Ex for fitting S030 or S070 (to be ordered separately)

Specifications	Voltage supply	Output	Electrical connection	Item no.
SE30 Ex - Namur II 1 G/D for explosive gas and dust environments: zones 0, 1 or 2 and 20, 21 or 22	8-15 VDC - via an intrinsic safety barrier with NAMUR input*	Namur current modulation - 2 wires	1 cable plug EN 175301-803	552 901
SE30 Ex - Namur II 2 D for explosive dust environments: zones 21 or 22	8-15 VDC or via a NAMUR input*	Namur current modulation - 2 wires	1 cable plug EN 175301-803	553 454
SE30 Ex - II 3 GD for explosive gas and dust environments: zones 2 or 22	12-36 VDC	NPN / PNP	1 cable plug EN 175301-803	552 353
SE30 Ex - Namur I M 1 for fiery mines	8-15 VDC - via an intrinsic safety barrier with NAMUR input*	Namur current modulation - 2 wires	1 cable plug EN 175301-803	553 455

* The open circuit voltage for the NAMUR input must be included between 8 and 15 V.

Ordering chart - spare parts for sensor Type SE30 Ex (to be ordered separately)

Specifications	Item no.
Cable plug EN 175301-803 (Type 2508) with blue cable gland and silicone gasket	167 562
Mechanical protection in stainless steel for mining application (80 x 80 x 80)	553 519

Safety barrier



- 2 or 4 channels, intrinsic safety digital inputs: proximity detectors NAMUR, contacts...
- Rail mount on hat profile 35 mm
- All connections by removable screw terminals

Specifications	
Digital inputs	Each of the 4 x intrinsic safety inputs can be configured independently for a contact or a proximity detector NAMUR as per DIN 19234.
Intrinsic safety inputs	Proximity detector NAMUR as per DIN 19234 or free potential contacts, relays, pressure or temperature switches or push buttons in hazardous area.
Non intrinsic safety recopy outputs	According to the type of sensor and the chosen logic: a green LED on the front panel displays a free-potential contact for each channel without common wire. Collector cut-off power: 15 V - 60 mA - 0.9 VA - 350 Hz
Selection of the sensor type	Inductive / capacitive intrinsic safety certified NAMUR proximity detector or free-potential contacts.
Selection of the logic	By a mini-DIP choice of the active output in presence or lack of target (proximity detector) or when contact is NO (Normally Open) or NC (Normally Closed).
Fault detector	For all inputs configured as NAMUR, all models are provided with fault detector (broken line or short-circuit). In faulty case, the green front LED switches off, the contact of the defective channel opens and the red LED corresponding to the defective channel switches on. Other channels are not affected.
Power supply	24 V DC $\pm 10\%$ 230 V AC $\pm 10\%$ 1 front panel yellow LED is "ON" when supply is active
Consumption	5 VA

Specifications (continued)	
Connections	All connections by removable screw terminals. Supply distribution by means of a flat cable from one unit to the next one.
Classification for explosive areas	Intrinsic safety associated apparatus. It must be installed in safe area and connected to materials installed in zone 0, 1 or 2 - Gas (G) or in zone 20, 21 or 22 - Dust (D) Classification according to ATEX 94/9/CE : Ex I/II (M1)/(1) G/D [EEEx ia] IIC Safety parameters see EC-type certificate LCIE 00ATEX 6034X
Ambient Temperature	Operating: -20°C to +60°C Storage: -20°C to +50°C (recommended) -40°C to +80°C
Dimensional and mechanical	Housing for symmetric DIN rail (hat profile 35mm as per standard NFC63015 / EN50022) - Depth : 120 mm ; Width on rail 29.5 mm ; - Height : 90 mm - 145 mm overall including space for cables. Minimal distance between rails : 180 mm.
Installations conditions	Mounting on DIN rail: must take into account thermal dissipation and risk of overheating generated by housings installed side by side. In case of a high concentration inherent safety barrier, we recommend to leave a free space of 10 mm between each group of 8 units (horizontal rail) and between each group of 4 units (vertical rail). Mounting inside a cabinet: It is recommended to close the electrical cabinet and to ensure a circulation of fresh air even by means of an air conditioner to keep the inside temperature at the level compatible with the recommended operating temperature among the units.

Ordering chart intrinsic safety barrier

Classifications for explosive areas	Voltage supply	Output	Number of channels	Item no.
ATEX 94/9/CE Ex I/II (M1)/(1) G/D [EEEx ia] IIC	24 VDC	open collector, 15V, 60 mA	2, with Namur input	553 456
		open collector, 15V, 60 mA	4, with Namur input	553 457
	230 VAC	open collector, 15V, 60 mA	2, with Namur input	553 458
		open collector, 15V, 60 mA	4, with Namur input	553 459

Interconnection possibilities with the sensor Type 8030

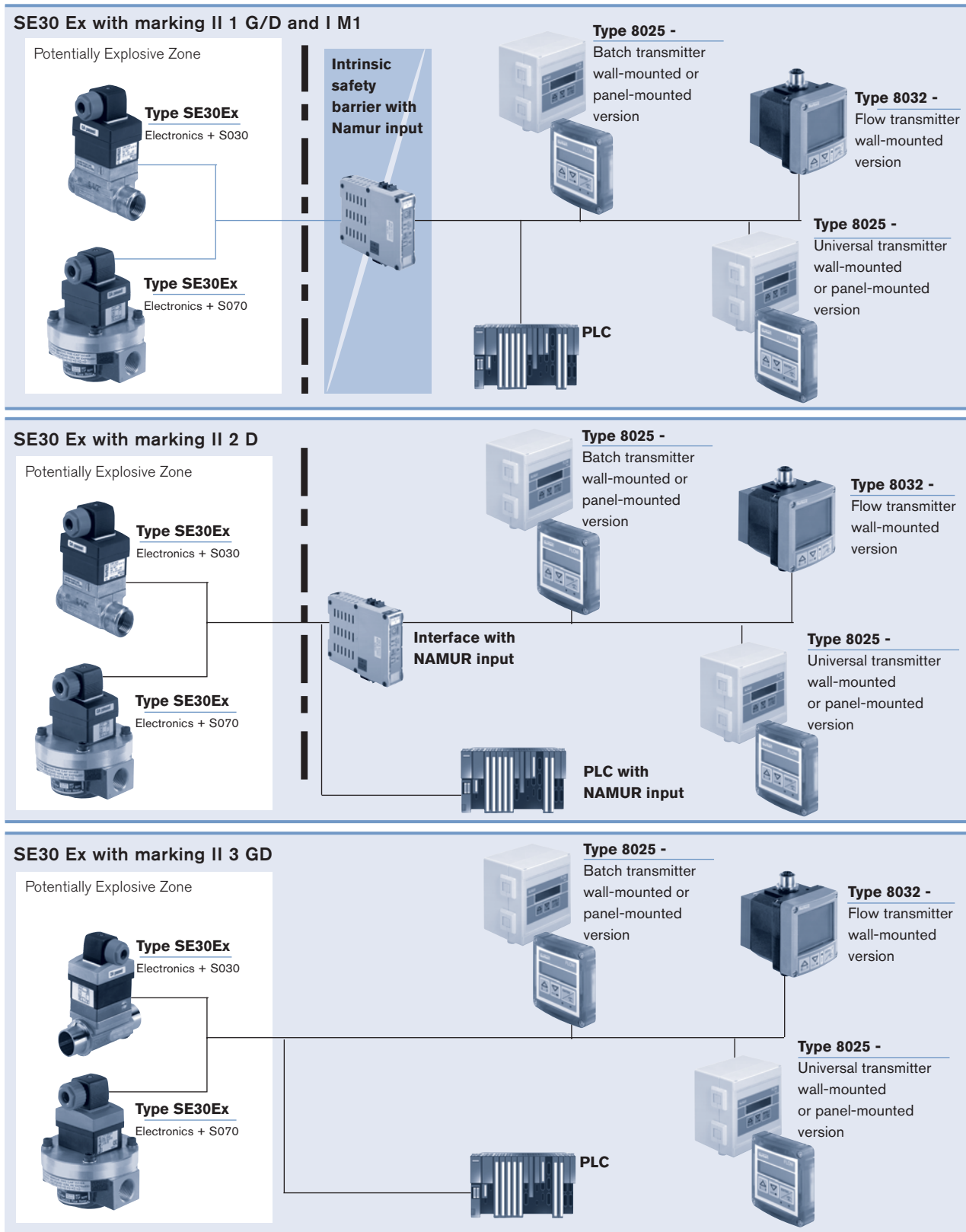

DTS 1000049988 EN Version: E Status: RL (released | freigegeben | valide) printed: 30.06.2006

To find your nearest Bürkert facility, click on the orange box →

www.burkert.com

In case of special application conditions, please consult for advice.

We reserve the right to make technical changes without notice.

0606/2_EU-en_00891929