

**WattMiser™**

# 2D™ and 2D™ Watt-Miser™

Compact Fluorescent Lamps Non-Integrated

16, 21, 28, 38W 2D™ Watt-Miser™ and 55W 2D™

DATA SHEET

## Product information

Biax™ 2D™ compact fluorescent lamps have been available for many years but GE is introducing the next generation of lamps under the name of 2D™ Watt-Miser™. These are available in 16, 21, 28 and 38 Watt in a wide choice of colour temperatures, these lamps are a direct replacement to existing 2D fixtures delivering the same life of 15,000 hours in case of 28 and 38 Watt but additional energy saving performance, 2D™ Watt-Miser™ lamps give similar lumen as the lamps they are replacing but up to 12% energy saving dependent upon ballast and wattage. Saving energy cost: 16W lamp runs on 14W\*, 21W lamp runs on 19W\*, 28W lamp runs on 24W\* and 38W runs on 34W\*.

In response to the demand from the market for a higher light output version of the 2D™ lamp, GE offers the 55W using the T5 28W/38W envelope size. The high luminous efficacy has been retained in the 55W by incorporating an amalgam which overcomes the fall in efficacy that occurs with increased lamp loading. The 55W lamp has a cap with dedicated key. The cap material withstands the higher temperatures generated by the increased lamp power while the modified holder key for the 55W 2D™ will prevent accidental insertion of any lower rated 2D™ lamp into a 55W socket. The T5 size (14% smaller overall diameter) will allow luminaire manufacturers to design new fittings with improved optical control in addition to the well-known uniformity of light of the Biax™ 2D™ concept

\*When used with electronic ballast

## Lamp technology

In response to the demand from the market for a lower energy consumption GE has invented the extra energy saving 2D™ Watt-Miser™. These lamps are designed to retrofit, into existing fixtures, provide similar lamps performance but save energy at the same time.



New 2D™ Watt-Miser™ lamps are energy saving compact fluorescent tubes formed into a "2D" shape. All types are available with a 4pin cap which permits use with conventional or electronic (high frequency) control gear, dimming and emergency lighting circuits. The 16-28W types are also available with 2pin cap which contains a starter switch and an EMC (RIS) capacitor.

## Features

- 16 & 28W 2D™ Watt-Miser™ lamp available in 2 & 4-pin versions
- 2-pin design with internal starter
- 4-pin design optimised for high frequency operation and also suitable for emergency lighting
- 21 & 38W 2D™ Watt-Miser™ lamp available only in 4-pin version
- Excellent colour rendering – CRI Ra 82
- Compatible with existing ballasts and fittings.



GE imagination at work

## Application areas

- Residential
- Domestic
- Hotels/motels/restaurants
- Utility areas
- Task lighting
- Emergency lighting

The flat profile makes the 2D™ Watt-Miser™ an ideal choice for building into slim, attractive luminaries. Its two dimensional shape is suitable for both up lighting and downlighting applications, where directional lighting is required. Due to its shallow, broad configuration, it spreads light over a large area without the need for expensive optics.

## Basic data

Nominal Wattage [W]	Rated Wattage on Standard Gear [W]	Energy consumption [kWh/1000h]	Volts 50Hz [V]	Cap	Product Description	Product Code Blister	Product Code Hanging Box	Nominal Lumen [lm]	Rated Lumen [lm]	Rated Lamp Efficacy on Standard Gear	CCT [K]	Mercury [mg]	Life 50Hz 3h [h]	EEC
<b>Biax™ 2D™ Watt-Miser™ 2-pin, Internal Starter</b>														
16	15.2	18.74	103	GR8	F162D/827 GE 20PK	41744**	-	1100	1100	72	2700K	3.0	12,000	A
16	15.2	18.74	103	GR8	F162D/835 GE 20PK	41745*	-	1100	1100	72	3500K	3.0	12,000	A
16	15.2	18.78	103	GR8	F162D/860 GE 20PK	41749**	-	1050	1050	69	6000K	3.0	12,000	A
28	26.5	31.71	108	GR8	F282DT5/827/2P BL 1/20 WM	10546*	-	2150	2150	81	2700K	3.0	15,000	A
16	15.2	18.74	103	GR8	F162D/T4/827/2P GE HB 1/10 WM	-	85135	1100	1100	72	2700K	3.0	12,000	A
16	15.2	18.74	103	GR8	F162D/T4/835/2P GE HB 1/10 WM	-	85138	1100	1100	72	3500K	3.0	12,000	A
16	15.2	18.78	103	GR8	F162D/T4/860/2P GE HB 1/10 WM	-	85140	1050	1050	69	6000K	3.0	12,000	A
28	26.5	31.71	108	GR8	F282D/T5/827/2P GE HB 1/10 WM	-	85109	2150	2150	81	2700K	3.0	15,000	A
<b>Biax™ 2D™/E Watt-Miser™ 4-pin, External Starter Required</b>														
16	15.2	15.4	103	GR10q	F162D/827/4P GE 20PK	41746**	-	1100	1100	72	2700	3.0	12,000	A
16	15.2	15.4	103	GR10q	F162D/830/4P BL1/20 WM	75066	-	1100	1100	72	3000	3.0	12,000	A
16	15.2	15.4	103	GR10q	F162D/835/4P GE 20PK	41747**	-	1100	1100	72	3500	3.0	12,000	A
16	15.2	15.4	103	GR10q	F16 2D/840/4P OEM102PK WM	41791	-	1100	1100	72	4000	3.0	12,000	A
21	20	20.9	103	GR10q	F212D/827/4P GE 20PK	41794**	-	1375	1375	69	2700	3.0	12,000	A
21	20	20.9	103	GR10q	F212D/835/4P GE 20PK	41806**	-	1375	1375	69	3500	3.0	12,000	A
21	20	20.9	103	GR10q	F212D/860/4P GE 20PK	41808***	-	1305	1305	65	6000	3.0	12,000	A
28	26.5	26.95	108	GR10q	F282DT5/827/4P BL 1/20 WM	10547**	-	2150	2150	81	2700	3.0	15,000	A
28	26.5	26.95	108	GR10q	F282D/830/4P BL1/20 WM	75068***	-	2150	2150	81	3000	3.0	15,000	A
28	26.5	26.95	108	GR10q	F282DT5/835/4P BL 1/20 WM	10567*	-	2150	2150	81	3500	3.0	15,000	A
28	26.5	26.95	108	GR10q	F282DT5/840/4P BL 1/20 WM	10548*	-	2150	2150	81	4000	3.0	15,000	A
38	37.5	37.95	110	GR10q	F382DT5/827/4P BL 1/20 WM	10550*	-	3020	3020	81	2700	3.0	15,000	A
38	37.5	37.95	110	GR10q	F382D/830/4P BL1/20 WM	75067	-	3020	3020	81	3000	3.0	15,000	A
38	37.5	37.95	110	GR10q	F382DT5/835/4P BL 1/20 WM	10566*	-	3020	3020	81	3500	3.0	15,000	A
38	37.5	37.95	110	GR10q	F382DT5/840/4P OEM32PK SLVLESS WM	23056	-	3020	3020	81	4000	3.0	15,000	A
38	37.5	37.95	110	GR10q	F382D/T5/860/4P LEG BL 1/20 WM	78336***	-	2860	2860	76	6000	3.0	15,000	A
16	15.2	15.4	103	GR10q	F162D/T4/827/4P GE HB 1/10 WM	-	85141	1100	1100	72	2700	3.0	12,000	A
16	15.2	15.4	103	GR10q	F162D/T4/835/4P GE HB 1/10 WM	-	85142	1100	1100	72	3500	3.0	12,000	A
16	15.2	15.4	103	GR10q	F212D/T4/827/4P GE HB 1/10 WM	-	85143	1100	1100	72	4000	3.0	12,000	A
21	20	20.9	103	GR10q	F212D/T4/835/4P GE HB 1/10 WM	-	85144	1375	1375	69	2700	3.0	12,000	A
21	20	20.9	103	GR10q	F212D/T4/860/4P GE HB 1/10 WM	-	85145	1375	1375	69	3500	3.0	12,000	A
21	20	20.9	103	GR10q	F282D/T5/827/4P GE HB 1/10 WM	-	85118	1305	1305	65	6000	3.0	12,000	A
28	26.5	26.95	108	GR10q	F282D/T5/830/4P GE HB1/10 WM	-	85120	2150	2150	81	2700	3.0	15,000	A
28	26.5	26.95	108	GR10q	F282D/T5/835/4P GE HB 1/10 WM	-	85130	2150	2150	81	3000	3.0	15,000	A
28	26.5	26.95	108	GR10q	F282D/T5/840/4P GE HB 1/10 WM	-	85132	2150	2150	81	3500	3.0	15,000	A
28	26.5	26.95	108	GR10q	F382D/T5/827/4P GE HB 1/10 WM	-	85133	2150	2150	81	4000	3.0	15,000	A
38	37.5	37.95	110	GR10q	F382D/T5/835/4P GE HB 1/10 WM	-	85134	3020	3020	81	3500	3.0	15,000	A
38	37.5	37.95	110	GR10q	F382D/T5/860/4P LEG HB 1/10 WM	-	85151	2860	2860	76	6000	3.0	15,000	A

\*Blister SKUs will be phased out, only Hanging box version will be available after inventory run out.

\*\*Will be phased out at latest April 2015.

\*\*\*Will be phased out at latest October 2015.

Nominal Wattage [W]	Rated Wattage on Standard Gear [W]	Energy consumption [kWh/1000h]	Volts 50Hz [V]	Cap	Product Description	Product Code Blister	Product Code Hanging Box	Nominal Lumen [lm]	Rated Lumen [lm]	Rated Lamp Efficacy on Standard Gear	CCT [K]	Mercury [mg]	Life 50Hz 3h [h]	EEC
<b>Biax™ 2D™ 4-pin, External Starter Required</b>														
55	56	61.6	98	GR10q-3	F552D/T5/827/A/4P LEG BL 1/20	78337*	-	3900	3900	72	2700K	3	10,000	A
55	56	61.6	98	GR10q-3	F552D/T5/830/4P A/T LEG BL 1/20	78339*	-	3900	3900	72	3000K	3	10,000	A
55	56	61.6	98	GR10q-3	F552D/T5/835/A/4P LEG BL 1/20	78340*	-	3900	3900	72	3500K	3	10,000	A
55	56	61.6	98	GR10q-3	F552D/T5/827/4P A LEG HB 1/10	-	85148	3900	3900	72	2700K	3	10,000	A
55	56	61.6	98	GR10q-3	F552D/T5/830/4P A/T LEG HB 1/10	-	85149	3900	3900	72	3000K	3	10,000	A
55	56	61.6	98	GR10q-3	F552D/T5/835/4P A LEG HB 1/10	-	85150	3900	3900	72	3500K	3	10,000	A

\*Blister SKUs will be phased out, only Hanging box version will be available after inventory run out.  
Note: CRI: 82, mercury: 3.0mg, pack quantity: 20, life on electrical gear [h]: see page 4.

## Spectral power distribution

CCT [K]	x	y	CRI [Ra]
2700	0.463	0.420	82
3000	0.440	0.402	82
3500	0.415	0.402	82
4000	0.380	0.377	82
6000	0.316	0.336	82

Spectral power distribution 2700K

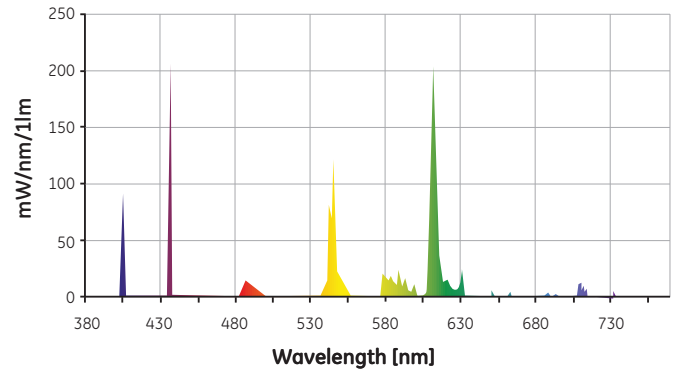

Spectral power distribution 3000K

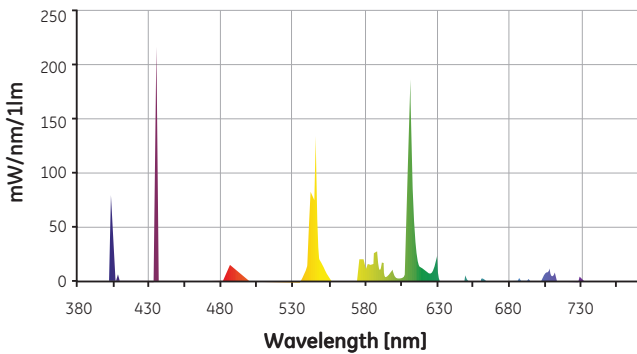

Spectral power distribution 3500K

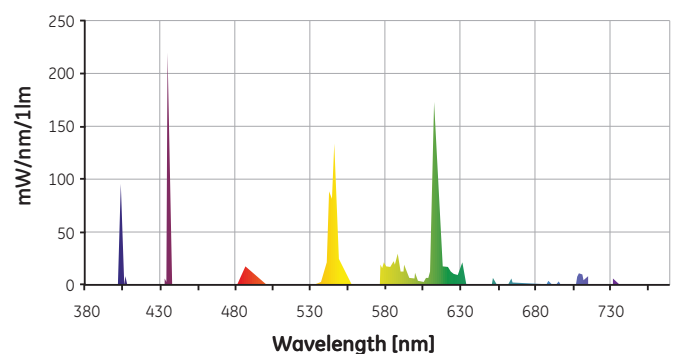

Spectral power distribution 4000K

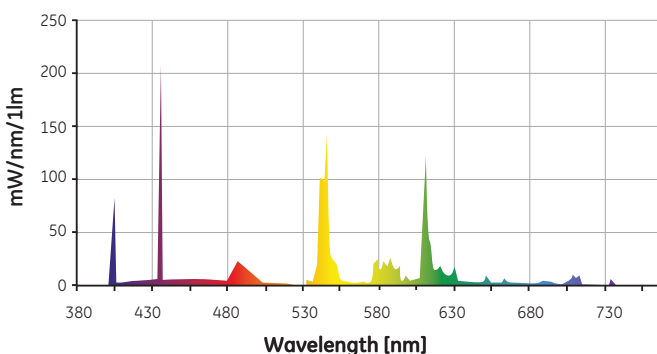

Spectral power distribution 6000K

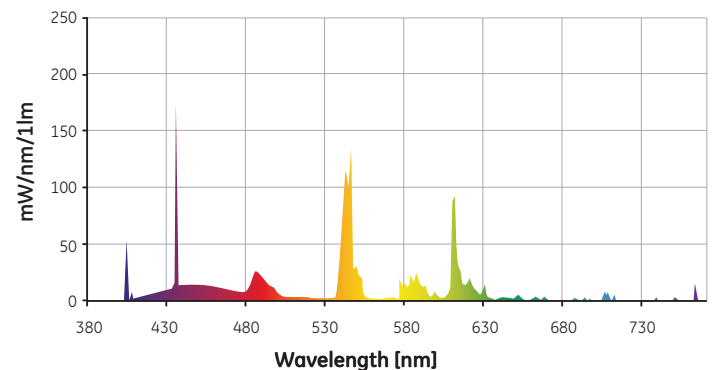

# Dimensions

## 2D™ T4

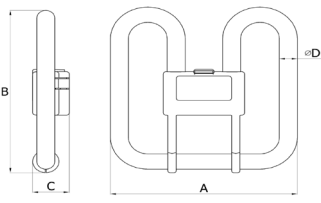

## 2D™ T5

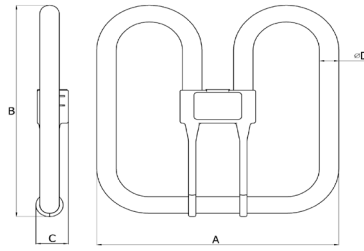

## 2D™ T5 WL

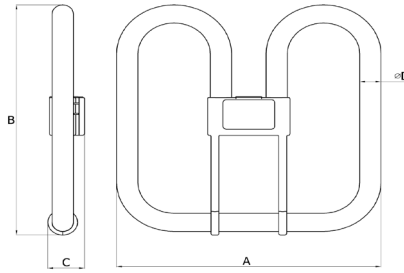

Wattage	A (max) [mm]	B (max) [mm]	C [mm]	D [mm]
16W	138	142	26.5	13
21W	138	142	26.5	13
28W	202	204	26.8	16
38W	202	204	26.8	16
28W WL	202	204	27.6	16
38W WL	202	204	27.6	16
55W WL	202	204	27.6	16

## CAPS/Connection Caps:



# Lamp life

Cathodes of a fluorescent lamp lose their electronemisivty during life due to the evaporation of emission mixture. When the deterioration reaches a certain level, the cathode breaks. Typical lifetime characteristics are based on GE Lighting's measurements according to the relevant IEC standards. The declared lamp life is the median life, which is when 50% of the lamps from a large sample batch would have failed. Real lifetime figures may depend on actual application. For instance improper cathode preheat, too high operating current, or too low operating current without additional cathode heating reduces the expected life.

### Test conditions:

- Horizontal burning position
- Switching cycle: 165 minutes on – 15 minutes off (3h) and 11h ON – 1h OFF (12h)
- 50Hz line frequency operation
- 25°C ambient temperature

### Life expectancy and lumen maintenance

2D™ Watt-Miser™ 16W on standard gear 3h

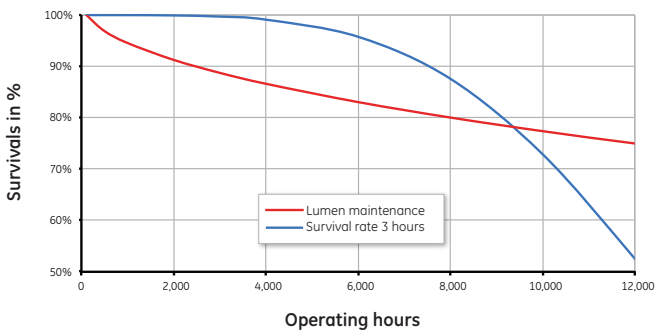

### Life expectancy and lumen maintenance

2D™ Watt-Miser™ 28W on standard gear 3h

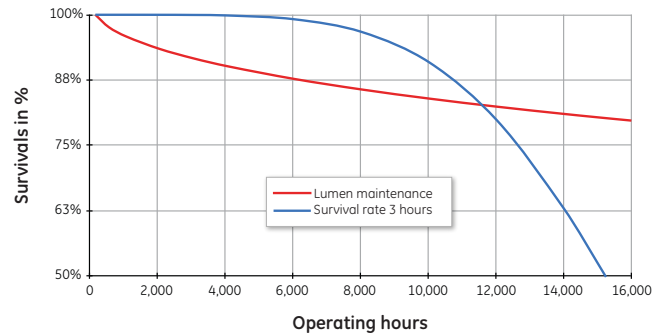

### Life expectancy and lumen maintenance

2D™ Watt-Miser™ 21W on standard gear 3h

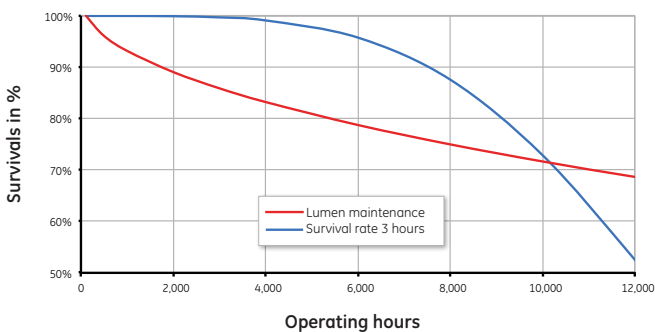

### Life expectancy and lumen maintenance

2D™ Watt-Miser™ 55W on standard gear 3h

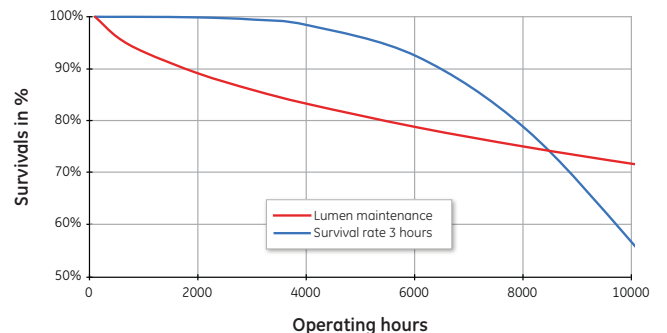

### Life expectancy and lumen maintenance

2D™ Watt-Miser™ 28-38W on electronic gear 3h and 12h

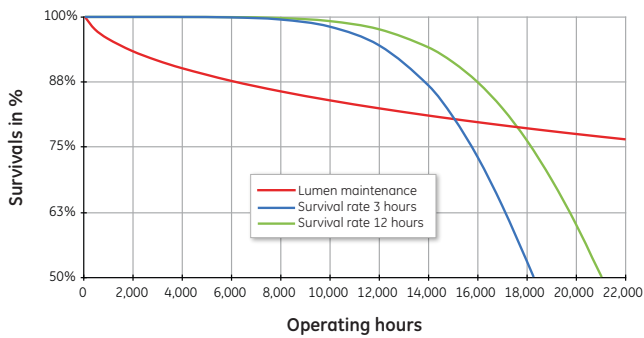

The impact on life of alternative switching cycles is shown in the graph “Life versus frequency of switching”. For very frequent switching applications it is possible to minimise the adverse effect of short on periods with the use of a suitable electronic starter. For lamps with an integral starter switch (2pin), the switch is designed to give approximately 20,000 starts which may be of more relevance than rated lamp life in a frequently switched situation. To achieve claimed life for high frequency operation a preheated start is recommended.

### Life versus frequency of switching

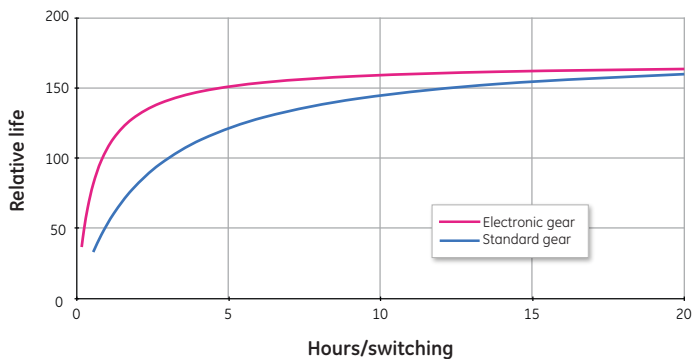

## Lumen maintenance

The lumen maintenance graph shows how the light output decreases throughout life. The main causes of the light depreciation are the deterioration of phosphor coating and end blackening due to the deposition of evaporated emission mixture on the glass tube. These effects are normal and unavoidable. The lumen maintenance curve given below for 2D™ Watt-Miser™ lamps is based on lumen readings under laboratory conditions.

#### Test conditions:

- Photometric sphere
- Horizontal burning position
- Switching cycle: 165 minutes On – 15 minutes Off
- 50Hz line frequency operation
- 25°C ambient temperature

## Lamp starting

The graph Starting voltage vs. ambient temperature shows electronic ballast open circuit voltage required for starting as a function of ambient air temperature. Data is based on measurements carried out by GE Lighting under controlled test conditions. Actual lamp starting voltage figures depend on the overall characteristics of electronic ballast. Appropriate preheating of cathodes is necessary in order to achieve low starting voltage and long lamp life.

### Starting voltages vs. ambient temperature

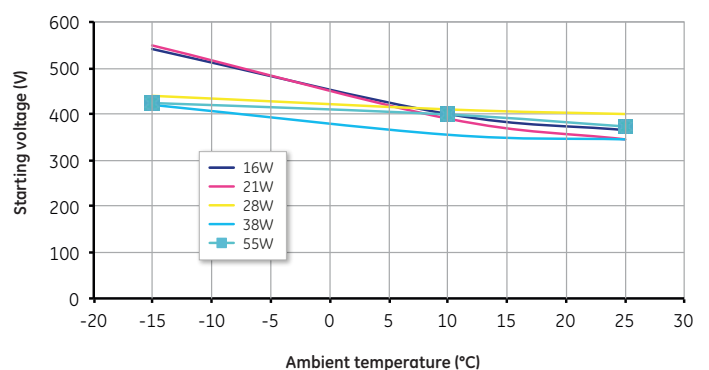

**Test conditions:**

- Horizontal lamp position
- Thermal chamber providing  $\pm 2^{\circ}\text{C}$  accuracy
- 2s current controlled preheat
- Sufficient preheat current
- Voltage ramp-up until ignition

Ambient temperature [ $^{\circ}\text{C}$ ]	Starting voltage [ $V_{\text{eff}}$ ]				
	16W	21W	28W	38W	55W
-15	540	550	440	420	425
+10	400	390	410	355	399
+25	365	345	400	345	373

## Minimum Starting Temperature

Lamp starting at low ambient temperatures can be successfully achieved, however light output during initial warm-up will be considerably reduced, but will gradually increase as lamp temperature rises. Use of an electronic starter or electronic ballast is recommended for lower ambient temperature applications. Satisfactory starting at lower ambient temperatures requires a close proximity earth (ground) plate.

Use of an electromagnetic ballast and glow starter is not recommended for applications below  $0^{\circ}\text{C}$ .

## Run-Up Time

When a fluorescent tube is switched on light output rises during the first few minutes until the optimum temperature is reached, but then falls if the temperature continues to rise.

Amalgam lamp technology provides maximum light output at a higher lamp operating temperature than standard liquid mercury dose technology, but warm-up time is longer. However the slower fall-off in light output at higher ambient/operating temperatures allows greater flexibility in luminaire design. As a consequence of the "slower" run-up characteristic amalgam lamps are not considered suitable for applications involving severe under-running associated with emergency lighting applications; where very short on-periods are likely or where low ambient temperatures are encountered, unless the fitting is fully enclosed.

Run-up time

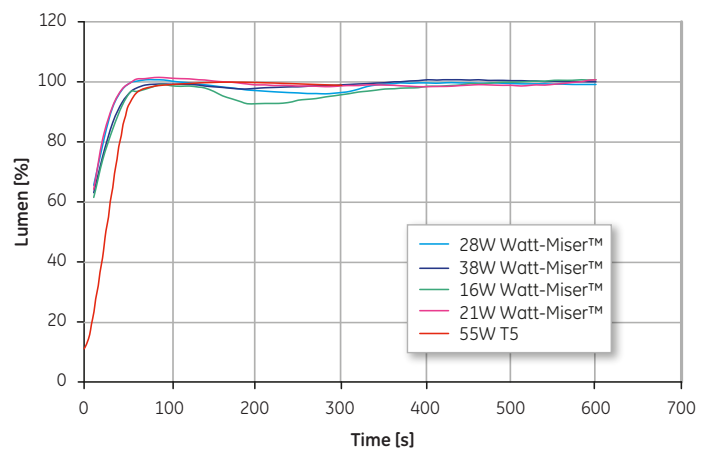

## Preheating requirements

Suitable preheating of cathodes prior to ignition is essential for long lamp life. The preheating requirement can be given by the following formula:

$$E = Q + P \cdot t$$

This energy is measured on a substitution resistor Q stands for the necessary thermal energy. P represents the power loss due to the heat transmission from the cathode. The longer the preheating, the more the power loss. The two basic preheating modes, the current controlled and the voltage controlled modes, can be derived from the formula.

Preheat energy vs time

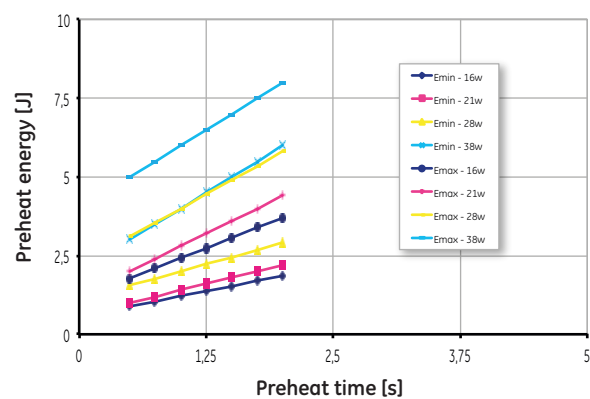

Description	Minimum energy			Maximum energy		
	[Q]	[P]	[ $R_{\text{sub}}$ ]	[Q]	[P]	[ $R_{\text{sub}}$ ]
16W	0.57	0.64	40	1.14	1.28	50
21W	0.6	0.8	18	1.2	1.6	25.5
28W	1.1	0.9	12	2.2	1.8	16
38W	2	1	5.6	4	2	8.2

# Influence of ambient air temperature

## Lamp performance

The lamp performance parameters, such as luminous output, lamp voltage and power depend on the mercury vapour pressure in the discharge tube. The mercury vapour pressure is a function of the thermal conditions around the lamp. The burning position, air flow, and radiated heat have an effect on these conditions. The curve shows the relative luminous output as function of the ambient temperature in horizontal burning positions. Tests were performed in draught-free air under thermally controlled conditions.

### Test conditions:

- Thermal chamber with  $\pm 2^{\circ}\text{C}$  accuracy
- Draught-free air

Light output vs. ambient temperature

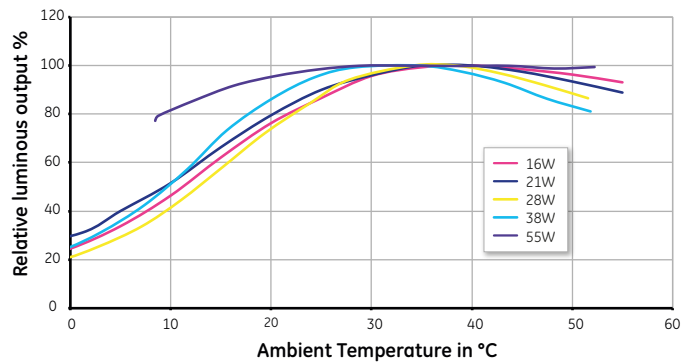

## Luminous intensity distribution

The following diagrams show the polar light intensity distribution of the 2D™ Watt-Miser™ 28-38W lamp.

Burning position: horizontal

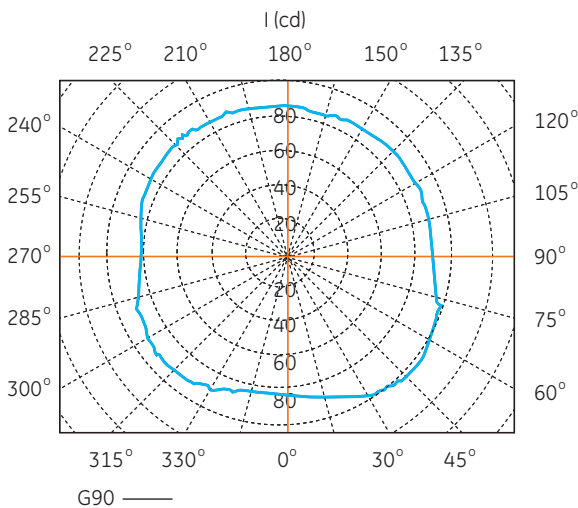

Burning position: vertical

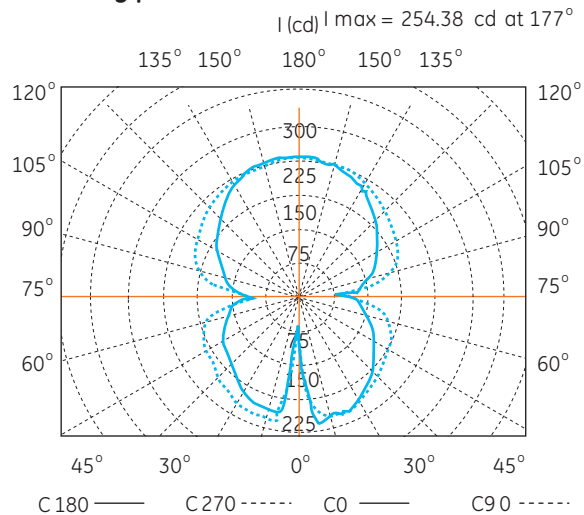

## Ballast compability\*

### Control Gear - High Frequency (electronic gear)

Watt	Manufacturer	Catalogue Code	Dimmable	Emergency	Comment
16	TRIDONIC	PC 1/10/13 TCD PRO	×		
16	TRIDONIC	PC 1x5-16W BASIC			
16	TRIDONIC	PCA 1/18 ECO			
21	TRIDONIC	PC PRO 18 FSQ b101			
21	OSRAM	QT-ECO x1x18-24/220-240L			High TDH%, low power factor ballast
21	HELVAR	EL 1/2x18-42TC		×	
28	HÜCO	BL-HP 1x28W TC-DD HC DIM	×		
28	HÜCO	BL 1x28W TC-DD HMC			High TDH%, low power factor ballast
28	VOSSLOH	ELXc 128.869			
28	OSRAM	QUICKTRONIC QT-M1x26-42			
28	TRIDONIC	PC 1x28DD PRO			
28	TRIDONIC	PC 1x28-33 HO DD COMBO		×	
28	HELVAR	EL 162x18-42TC			
38	HÜCO	BL-HP1x38W TC-DD HC DIM	×		
38	HÜCO	BL-HP 1x38W TC-DD HC			
38	TRIDONIC	PC 1x38W DD PRO			
38	TRIDONIC	PC 1x38-34 DD COMBO		×	
38	OSRAM	QUICKTRONIC QT-M 1x26-42			
38	VOSSLOH	ELXc 142.835			
38	ERC	Mectronic SQU			

## Control Gear - Mains Frequency (standard gear)

Watt	Volt	Manufacturer	Catalogue Code
16	230	Tridonic. Atco	EC16 B27 230/50
16	230	Helvar	L16D/230
16	230	Helvar	L16DL/230
16	230	ERC	MEC92 16W
16	230	ERC	MEC75/NANO 16W
16	240	Tridonic. Atco	EC16 B27 240/50
16	240	Helvar	L16D/240
16	240	Helvar	L16DL/240
16	240	Vossloh-Schwabe	L16113
16	240	ERC	MEC92 16W
16	240	ERC	MEC75/NANO 16W
21	230	Helvar	L21TL-100
21	230	Vossloh-Schwabe	L21.314
21	230	Tridonic. Atco	EC21 B501K 230/50
21	240	Tridonic. Atco	EC21 B502K 230/50
28	230	ERC	MEC04-LB/28W
28	230	Helvar	L18TL2
28	230	Helvar	L18TLB2
28	230	Tridonic. Atco	EC18B501K
28	230	Tridonic. Atco	EC18LC501K
28	230	Vossloh-Schwabe	LN18.708
28	240	ERC	MEC04-LB/28W
28	240	Helvar	L18TL2
28	240	Helvar	L18TLB2
28	240	Tridonic. Atco	EC18B502K
28	240	Tridonic. Atco	EC18LC502K
28	240	Vossloh-Schwabe	LN18.507
38	230	ERC	MEC04-LB/36-40W
38	230	Helvar	L36TL2
38	230	Helvar	L36TLB2
38	230	Tridonic. Atco	EC36B501K
38	230	Tridonic. Atco	EC36TLB501K
38	230	Vossloh-Schwabe	LN36.511
38	240	ERC	MEC04-LB/36-40W
38	240	Helvar	L36TL2
38	240	Helvar	L36TLB2
38	240	Tridonic. Atco	EC36B502K
38	240	Tridonic. Atco	EC36TLB502K
38	240	Vossloh-Schwabe	LN36.505

\*Ballast manufacturers have the right to change ballast specification without prior notification or official announcement so these data based on GE measurement 2010/2011.

## Gear specification

### Cathode resistances

Nominal Power	Cap	Standard datasheet 60901-IEC	Test current [A]	Cathode resistance @ test		
				Rated [ohm]	min [Ohm]	max [ohm]
16	GR10q	3016*	0.13	64	48	80
21	GR10q	3021*	0.195	26.5	20	33
28	GR10q	3028*	0.27	17.5	13.1	21.9
38	GR10q	3038*	0.42	9	6.75	11.25
55	GR10q3	3055*	0.45	7.5	5.6	9.3

### Cathode preheat requirements

Nominal Power	Cap	Standard datasheet 60901-IEC	$E_{min} = Q_{min} + P_{min} * ts$			Cathode resistance @ test		
			$Q_{min}$ [J]	$P_{min}$ [W]	$R_{sub,min}$ [ohm]	Rated [ohm]	min [Ohm]	max [ohm]
16	GR10q	3016*	0.9	0.6	40	1.8	1.2	50
21	GR10q	3021*	0.6	0.8	18	1.2	1.6	25.5
28	GR10q	3028*	1.1	0.9	12	2.2	1.8	16
38	GR10q	3038*	2	1	5.6	4	2	8.2

\* proposal to IEC

### Dimming requirements

Nominal Power	Cap	Standard datasheet 60901-IEC	$I_{d,min}$ [A]	$I_{d,max}$ [A]	X [A2]	Y [A]
16	GR10q	3016*	0.015	0.11	0.03	0.24
21	GR10q	3021*	0.02	0.155	0.068	0.36
28	GR10q	3028*	0.027	0.215	0.13	0.5
38	GR10q	3038*	0.04	0.34	0.32	0.78

### Starting requirements

Nominal Power	Cap	Standard datasheet 60901-IEC	Ignition voltage [V <sub>rms</sub> ]	Non-ignition voltage [V <sub>rms</sub> ]	$R_{sub}$ [ohm]
16	GR10q	3016*	550	265	40...120
21	GR10q	3021*	500	265	18...54
28	GR10q	3028*	550	265	12...36
38	GR10q	3038*	550	265	5.6...16.8
55	GR10q3	3055*	510	265	5...15

\* proposal to IEC

## Operating notes

2-pin 2D™ Watt-Miser™ lamps are unsuitable for use in dimming circuits or from an electronic ballast and should not be used for these applications. The 4-pin 2D™ Watt-Miser™ lamps can be operated from electronic control gear and dimmed using appropriate control gear. The 2D™ Watt-Miser™ lamps can be operated in any position except where leg "a" is higher than bends b in case of 38W types. This limitation is necessary to ensure that region Ø of cap is kept as cool as possible.

## Operating position

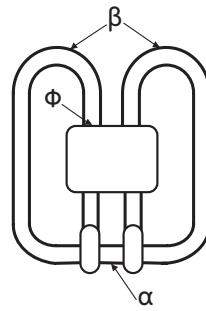

## Circuit diagrams

### 2-pin, electromagnetic ballast (single lamp)

LH = Lamp Holder  
B = Ballast

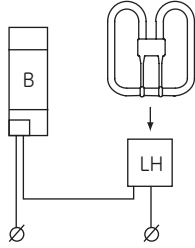

### 4-pin, electronic ballast (single lamp)

LH = Lamp Holder  
E = Electronic Gear

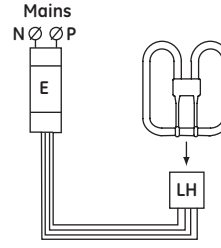

### 4-pin, automatically switched emergency lighting

LH = Lamp Holder  
E = Electronic Gear  
EG = Emergency Gear  
B = Battery

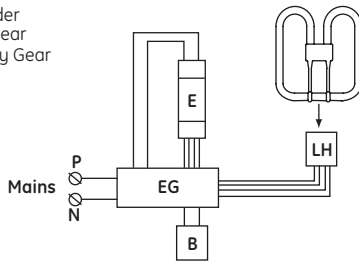

### 4-pin, electronic dimming ballast

LH = Lamp Holder  
E = Electronic Gear  
D = Dimmer  
S = Sensor or control

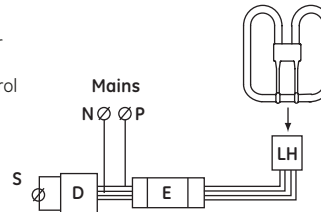

## Additional notes

All 2D™ Watt-Miser™ lamps have a long tip-off tube which acts as a cool spot into which the liquid mercury reservoir (required by all fluorescent lamps) migrates during early lamp operation. In relation to circuit or fittings design or ballast evaluation, tests should be conducted with lamps aged to a minimum of 500 hours with care being taken to keep the mercury in this "cool spot". In practice this means either the lamp should be left undisturbed in the ageing position or if the lamp is moved avoid mechanical shock. The 2D "loops" should be kept above the straight lamp region (90° bends). This procedure is recommended to ensure that liquid mercury is fully retained in the cool spot tip-off tube.

4-pin lamps can be operated directly from 220/250V 50/60Hz mains supplies using an electromagnetic ballast and external glow or electronic starter. Recommended GE glow starters are 155/500 and 155/400. 2D™ Watt-Miser™ 16, 21, 28 and 38W lamps operate flicker-free only with GE 155/400 starters. For supply voltages above or below the range 220/250V, a transformer or other suitable means of adjusting the supply voltage is necessary. Operation from an electronic ballast maximises lamp photometric and survival performance.

2D™ Watt-Miser™ lamps are standardised internationally through the International Electrotechnical Commission (IEC). For lamp performance the relevant data sheets in IEC 60901 (EN 60901) apply and for lamp safety the relevant clauses in IEC 61199 apply. Watt-Miser™, Biax™ and 2D™ are registered protected trademarks. Unapproved use of trademarks are illegal.

# Compliance

---

## Standards

IEC 60061-1	Lamp caps and holders together with gauges for the control of interchangeability and safety
IEC or EN 60901	Single-capped lamps - performance requirements
IEC or EN 61199	Single-capped lamps - safety requirements
CIE S 009/E:2002	Photobiological safety of lamps and lamp systems

---

## European Directives

CE mark	93/68/EEC; LVD: 2006/95/EC; Ecodesign 2005/32/EC, ROHS 2011/65/EU
Energy Labelling	Directive 2010/30/EU, 874/2012/EU energy labelling of electrical lamps and luminaires
RoHS	Directive 2011/65/EU on Restrictions of the use of certain Hazardous Substances (RoHS)
WEEE	Directive 2012/19/EU on Waste Electrical and Electronic Equipment (WEEE)
REACH	Directive 2006/1907/EC on Registration, Evaluation, Authorisation and Restriction of Chemicals (REACH)
ErP ecodesign	Directive 2005/32/EC, 2009/245/EC ecodesign requirements (of Energy-related Products) for tertiary sector lamps

---