

Datasheet

Wirewound Potentiometer CLR4000 Series with a 6.35 mm Dia. Shaft 2kΩ ±10% 1.5W, Panel Mount

RS Stock 812-831



Dimensions: (mm)

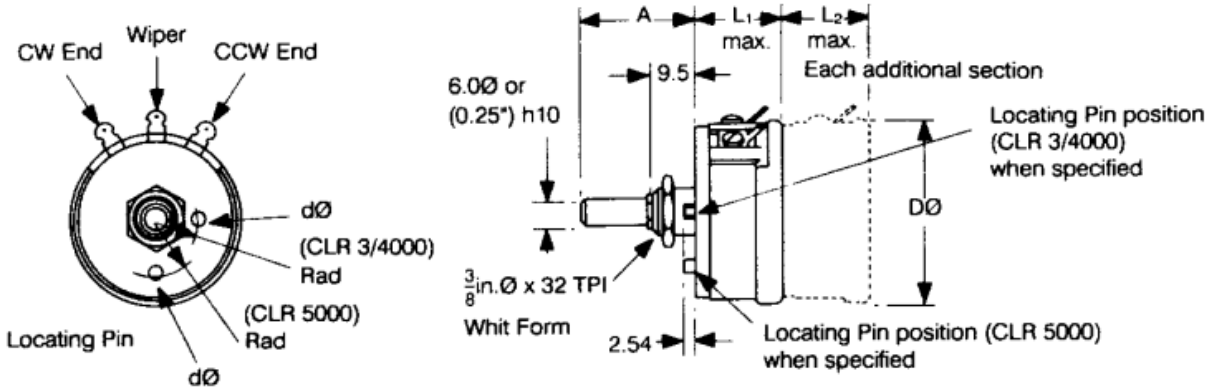

Features

- Up to four sections can be ganged together on a common spindle.
- Phenolic body moulding; nickel silver contact; nickel plated brass spindle and bush; hot tin dipped brass tags.
- Selection Tolerance: $\pm 10\%$
- Terminal Resistance: Maximum of 0.2Ω or 0.01% (1Ω or 0.1% : CLR 7000) f nominal resistance whichever is the greater
- Rational Noise: 100Ω E.N.R maximum
- Temperature Characteristic of Resistance: $+ 0.75\%$ ($+20^{\circ}\text{C}$ to $+ 70^{\circ}\text{C}$)
- Insulation Resistance: $1000\text{M} \Omega$ minimum at 500v d.c
- Isolation Voltage: 1000V a.c peak
- Linearity: 1% typical, 2% maximum

Series 4000 Electrical Specification

Power Rating @ 70°C Linear Law	1.5W
Angle of effective rotation	$275^{\circ} \pm 5^{\circ}\text{C}$
Total mechanical rotation	$290^{\circ} \pm 10^{\circ}\text{C}$
Limiting element voltage d.c or a.c . R.m.s	500V

Standard Resistance Laws

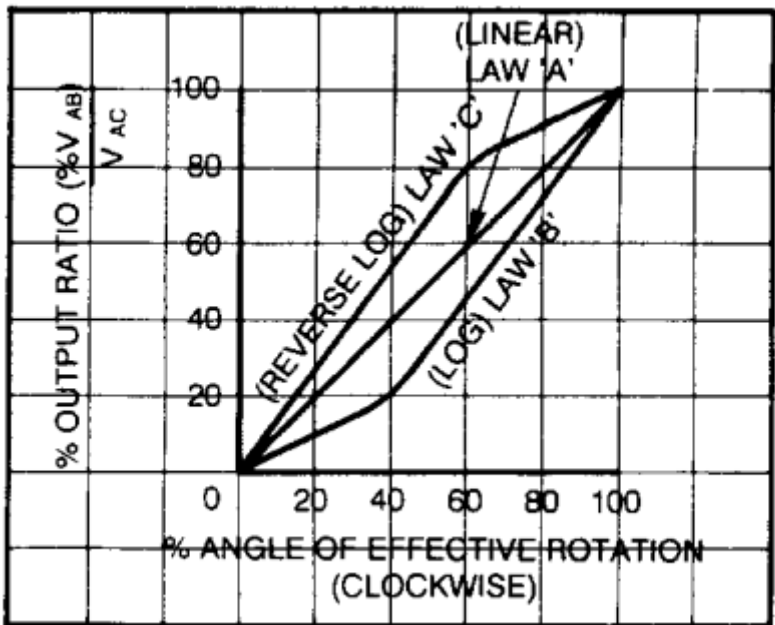

Alignment (Ganged Units)

Sections are aligned to within + 1% at reference point of zero effective rotation



Mechanical Rotation

- Starting Torque: 7 to 35mNm
- Rotational Life: 20,000 cycles
- No of Gangs (max) : 4
- End Stop Torque: 1100Nm

Environmental Specification

- Vibration: 10 to 500Hz; 10g; Rac \leq 1%
- Bump: 4000 bumps; 390m/s², 40g; Rac \leq 1%
- Load Life: 1000h at rated dissipation ; Rac \leq 1%

