

DETAILS

Product Number	F14468_FLORENCE-1R-Z60
Family	Florence
Type	Lens
Color	clear
Diameter	19,5 x 286 mm
Height	7,55 mm
Style	rectang
Optic Material	PMMA
Holder Material	
Fastening	clips
Status	ready
ROHS Compliant	Yes
Date Updated	5/05/2015



OPTICAL PROPERTIES

LED	Viewing	Light	Efficiency	cd/lm	Connector
	Angle	Beam			
Luxeon 3030 2D	57+114 deg	Medium	94 %	0.600	-
Duris S5 (2 chip)	58+114 deg	Medium	94 %	0.590	-
Fortimo LED Line 1ft 1100lm 8x0 1R xV258+111 deg	58+114 deg	Medium	94 %	0.600	-
MP-2016	58+115 deg	Medium	94 %	0.630	-
NF2x757D	59+114 deg	Medium	94 %	0.570	-
LM302A	59+111 deg	Medium	94 %	0.600	-
LM561B	59+111 deg	Medium	94 %	0.580	-
SEOUL 3030	59+111 deg	Medium	94 %	0.600	-
Luxeon 3535	60+109 deg	Medium	94 %	0.590	-
XH-B/G	63+113 deg	Medium	94 %	0.540	-

H G F E D C B A

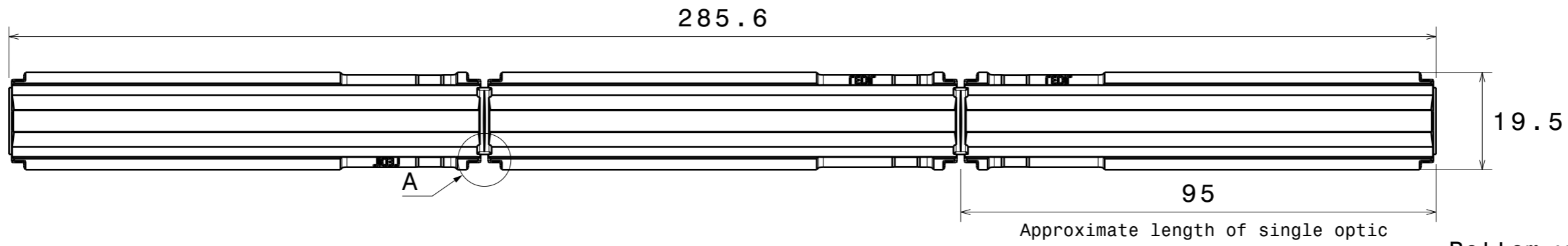

Bottom view

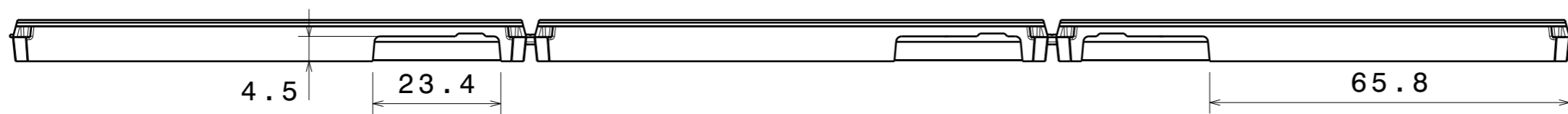

Left view

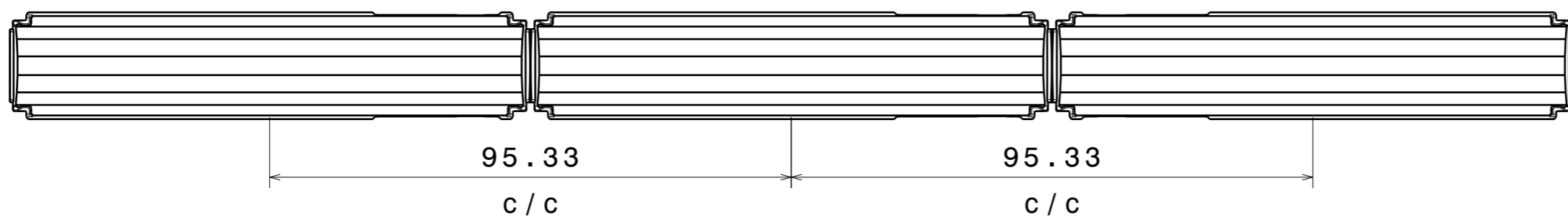

Top view

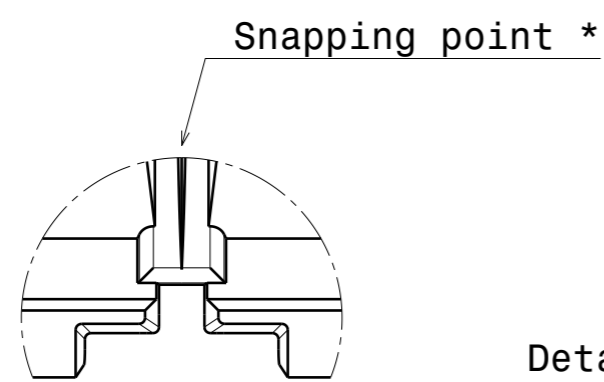

Detail A
Scale 4:1

* Optics can be snapped along this line and used also as single parts.

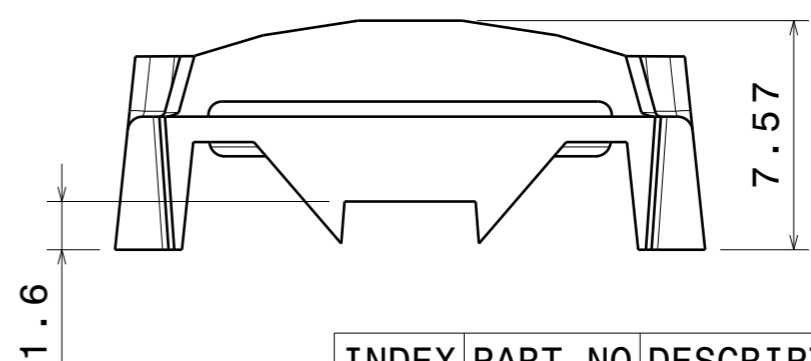

Front view
Scale 4:1

INDEX	PART NO	DESCRIPTION	MATERIAL	COLOUR
1	F14468	FLORENCE-1R-Z60	PMMA	

LEDiL LediL Oy
Salorankatu 10
FIN 24240 SALO
Finland

Tolerances if not otherwise shown
According to DIN ISO 2768-1
Linear measures:
Up to 30mm class M, otherwise class C.
According to DIN ISO 2768-2
Form and position: class L

THIRD ANGLE PROJECTION:

DRAWING TITLE
F14468_FLORENCE-1R-Z60

This drawing is the property of LEDiL Oy. It may not be reproduced, copied or communicated without a written agreement with LEDiL Oy.

SIZE	PART NUMBER
A3	F14468

SCALE	1:1	SHEET	1/1
-------	-----	-------	-----

H G B A

Ledil F14468_FLORENCE-1R-Z60_(Luxeon_3030_2D) / LDC (Linear)

Luminaire: Ledil F14468_FLORENCE-1R-Z60_(Luxeon_3030_2D)
Lamps: 1 x Luxeon_3030_2D_x22_(L130-4080003000W21)
_1601.44lm@200mA_CCT=4000K_P=12.8W_I=0.2A

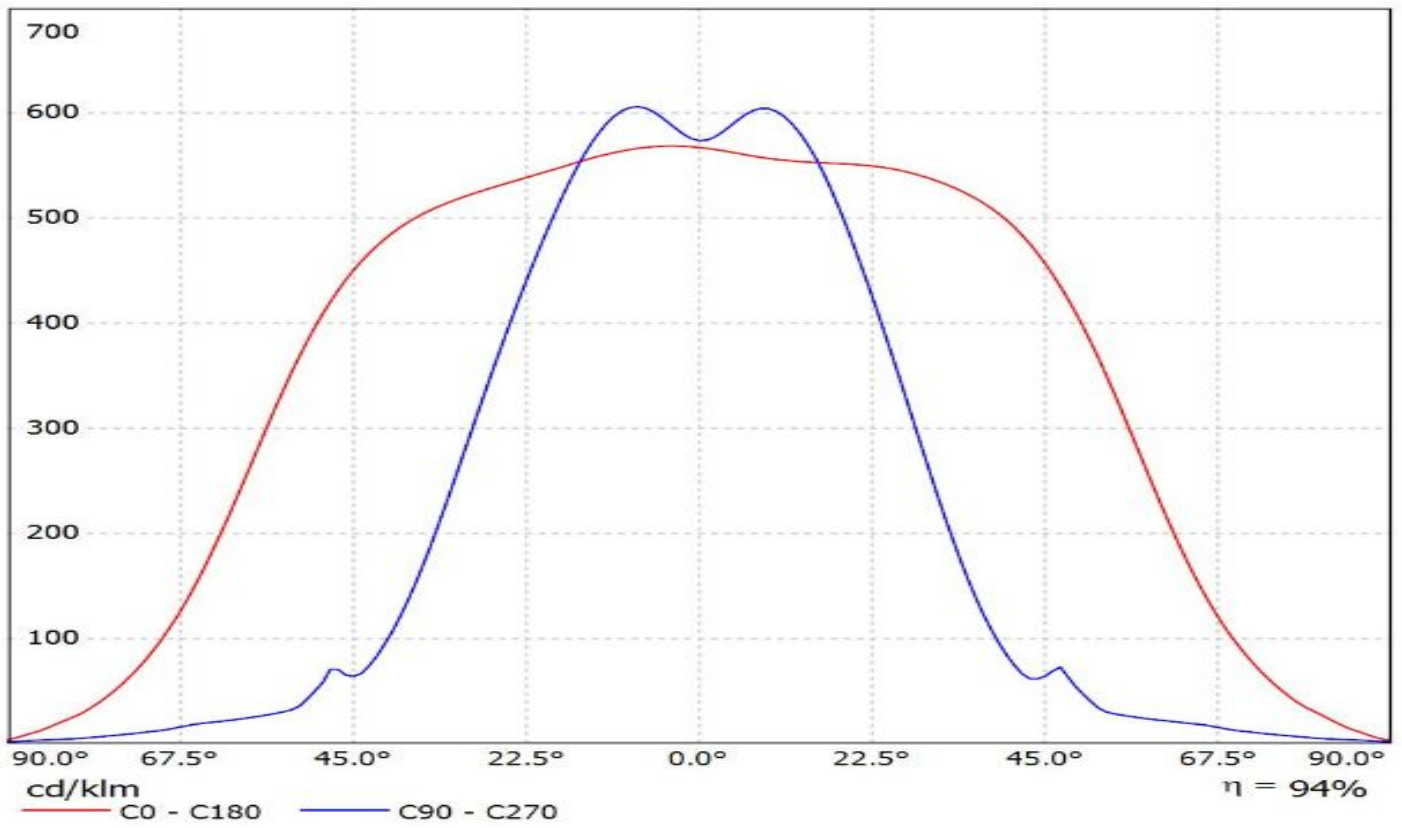

Luminaire: Ledil F14468_FLORENCE-1R-Z60_(Duris_S5)

Lamps: 1 x Osram_Duris_S5_(GW_PSLRS1.EC-LQLS-5H7I-1)_993.467lm@100mA_P=8W_I=0.1000A

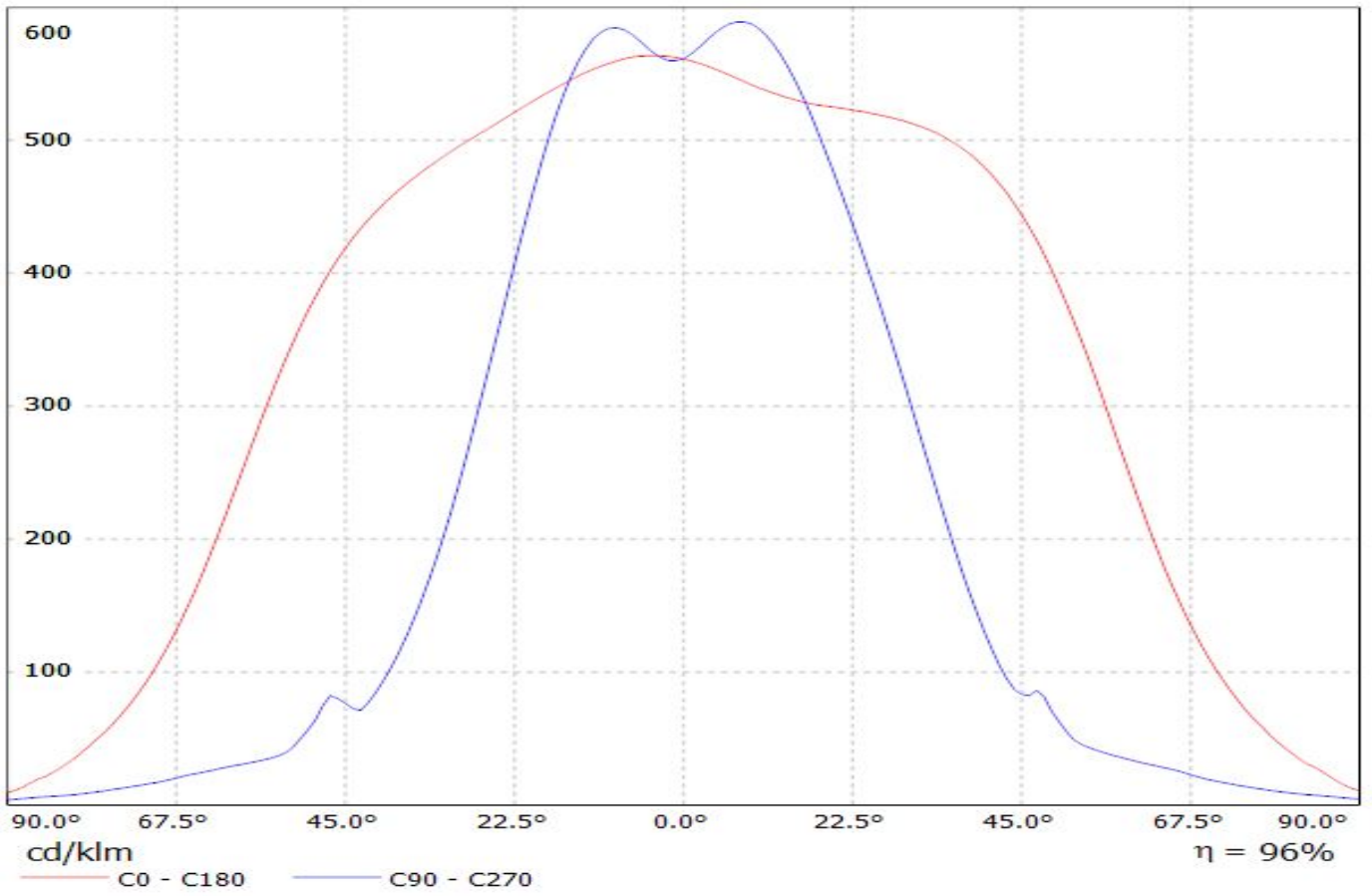

Luminaire: LEDiL Oy F14468_FLORENCE-1R-Z60 (Fortimo_LED_Line_1ft_1100lm_840_1R_LV2)_Cav4
Lamps: 1 x Fortimo_LED_Line_1ft_1100lm_840_1R_LV2_1062.24lm@250mA_P=8.02208W_I=249.8mA

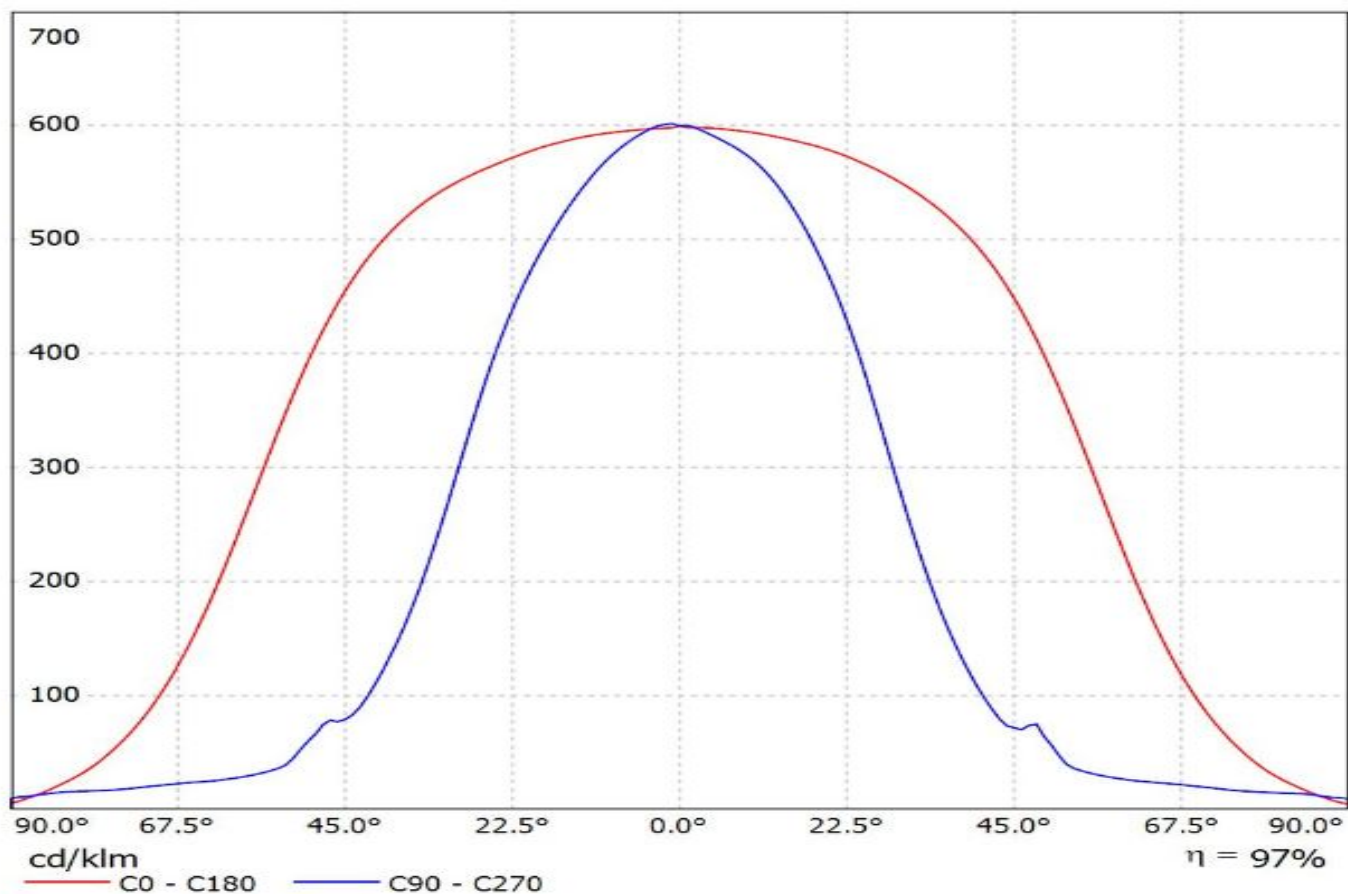

Ledil F14468_FLORENCE-1R-Z60_(NF2x757D) / LDC (Linear)

Luminaire: Ledil F14468_FLORENCE-1R-Z60_(NF2x757D)

Lamps: 1 x Nichia_NF2x757D_2chip_x22 (NF2W757DRT)_2050.61lm@200mA_P=12.95W_I=0.2A

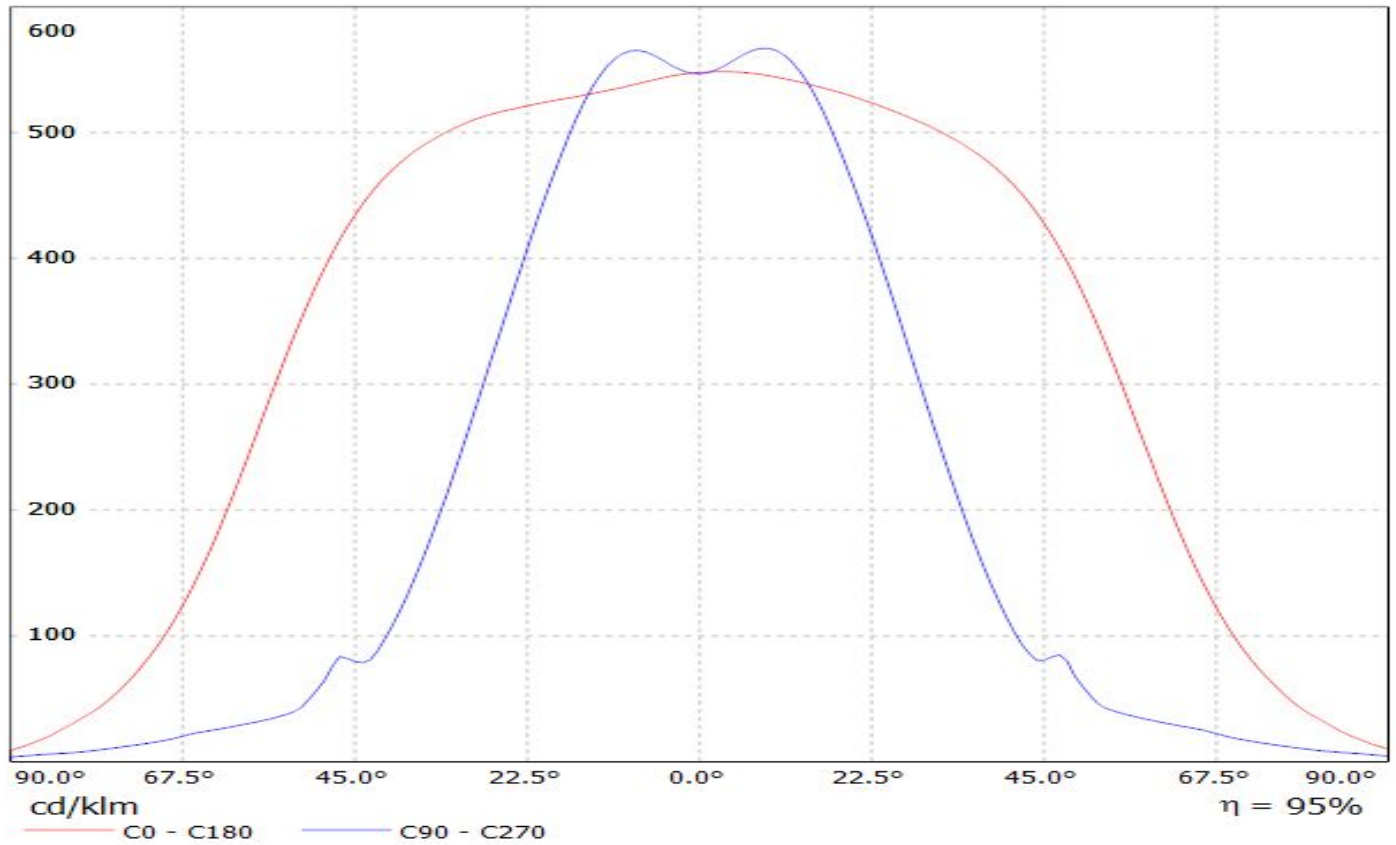

Luminaire: LEDiL Oy F14468_FLORENCE-1R-Z60_(LM302A)
Lamps: 1 x Samsung_LM302A_865.46lm@100mA_P=6.64694W_I=0.1001A

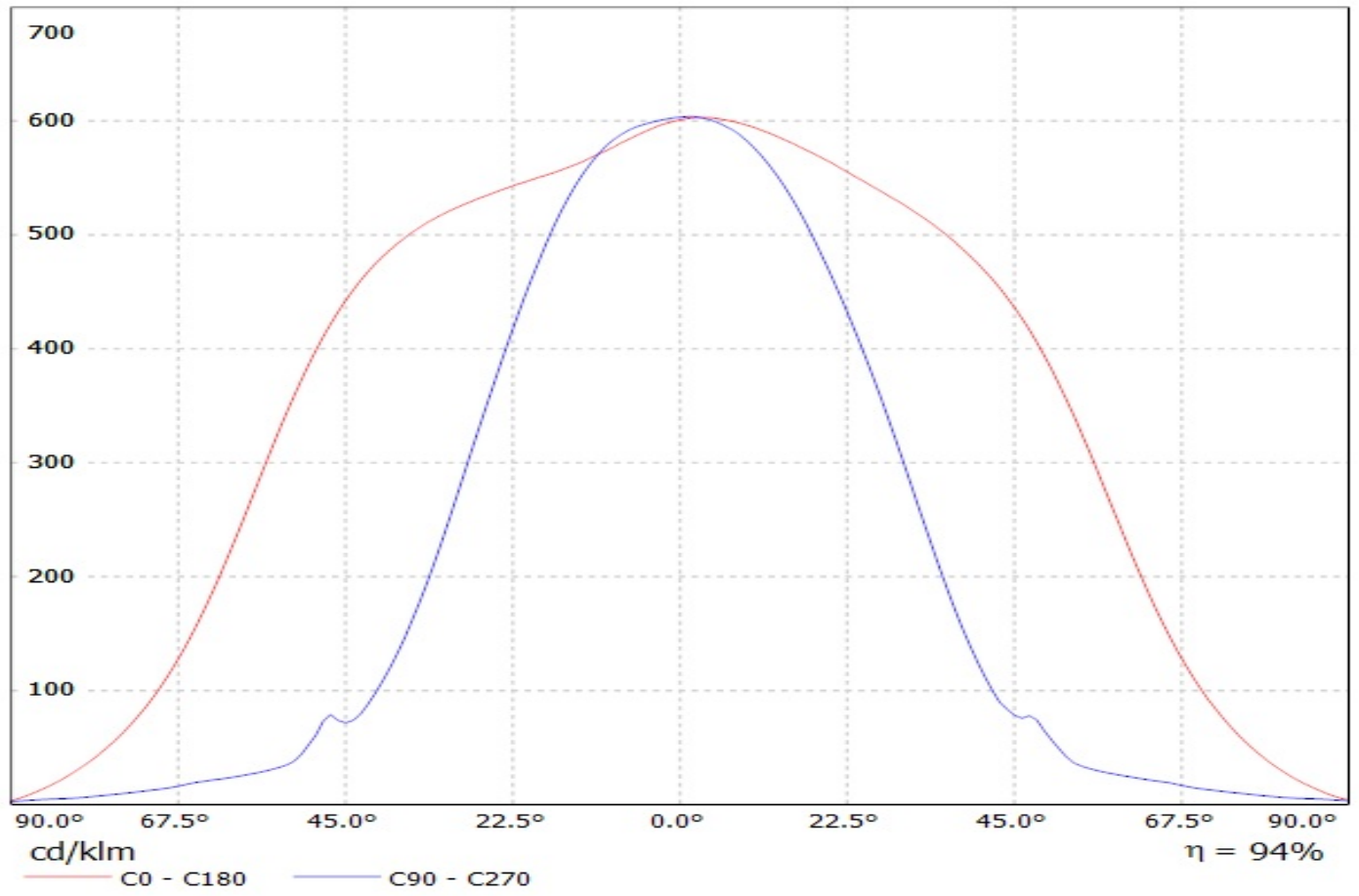

Ledil F14468_FLORENCE-1R-Z60_(LM561B) / LDC (Linear)

Luminaire: Ledil F14468_FLORENCE-1R-Z60_(LM561B)

Lamps: 1 x Samsung_LM561B_x22_348.84lm@65mA_P=1.97W_I=65mA

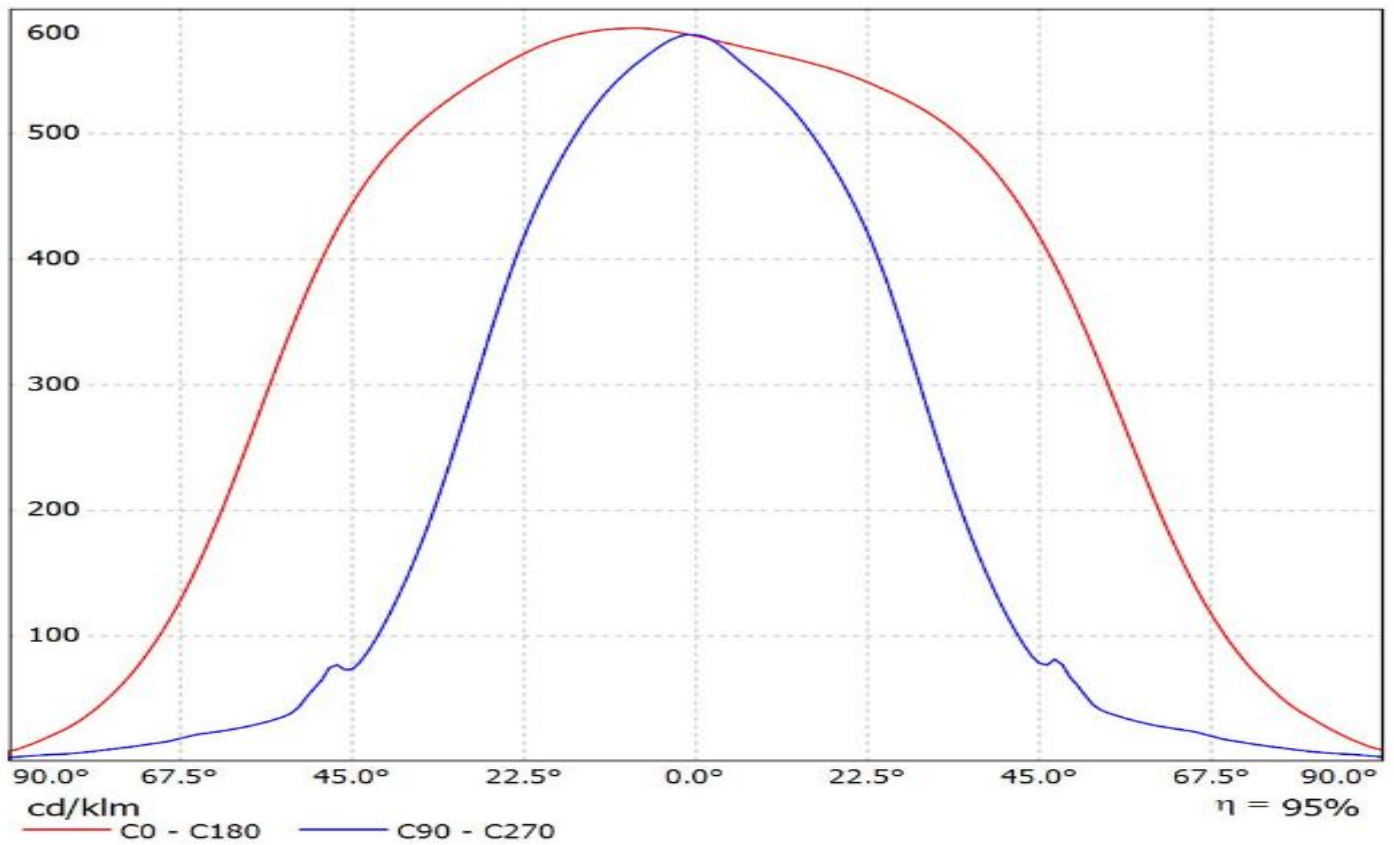

Ledil F14468_FLORENCE-1R-Z60_(Seoul_3030) / LDC (Linear)

Luminaire: Ledil F14468_FLORENCE-1R-Z60_(Seoul_3030)

Lamps: 1 x Seoul_3030_x11_(STW8C2SA)_785.296lm@100mA_P=6.5W_I=0.1A

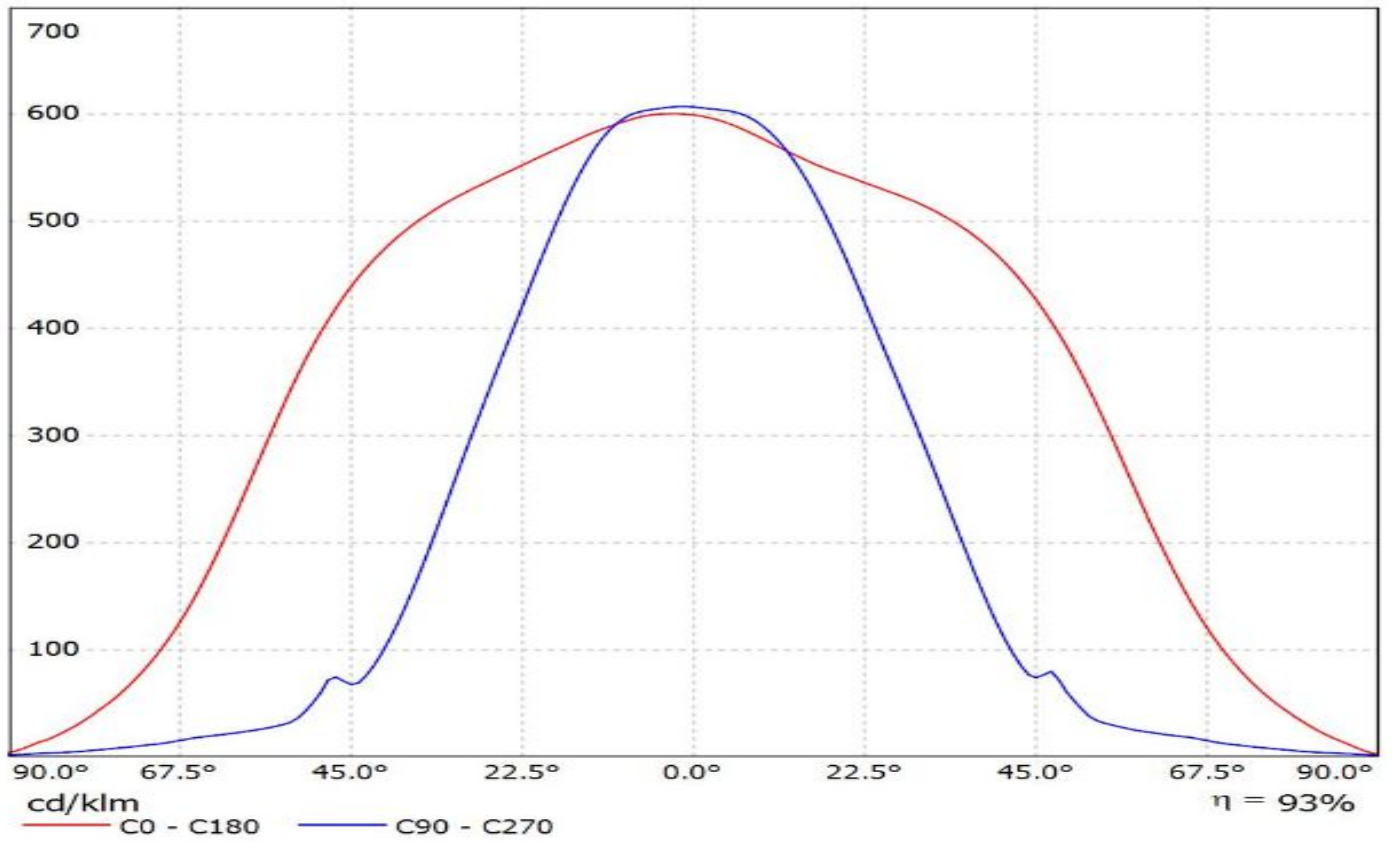

Ledil F14468_FLORENCE-1R-Z60_(Luxeon_3535_2D) / LDC (Linear)

Luminaire: Ledil F14468_FLORENCE-1R-Z60_(Luxeon_3535_2D)

Lamps: 1 x Luxeon_3535_2D_x22_(MXC8_4000K)_910.245lm@100mA_CCT=4000K_P=6.32W_I=0.1A

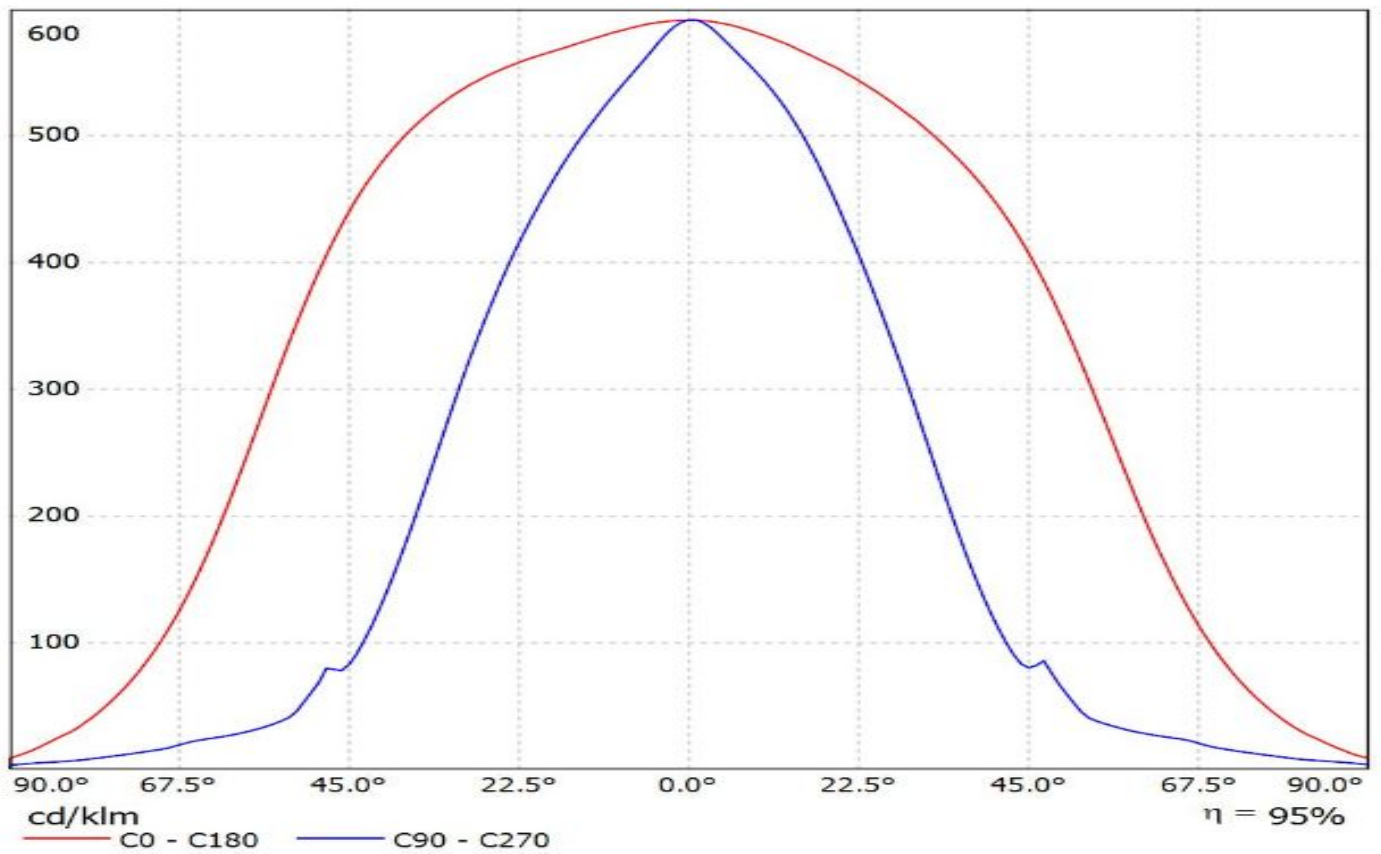

Ledil F14468_FLORENCE-1R-Z60_(XH-B) / LDC (Linear)

Luminaire: Ledil F14468_FLORENCE-1R-Z60_(XH-B)

Lamps: 1 x Cree_XH-B_x22_(XHBAWT-0-7B4-J20-0H-0001)_315.848lm@65mA_P=2.11W_I=65mA

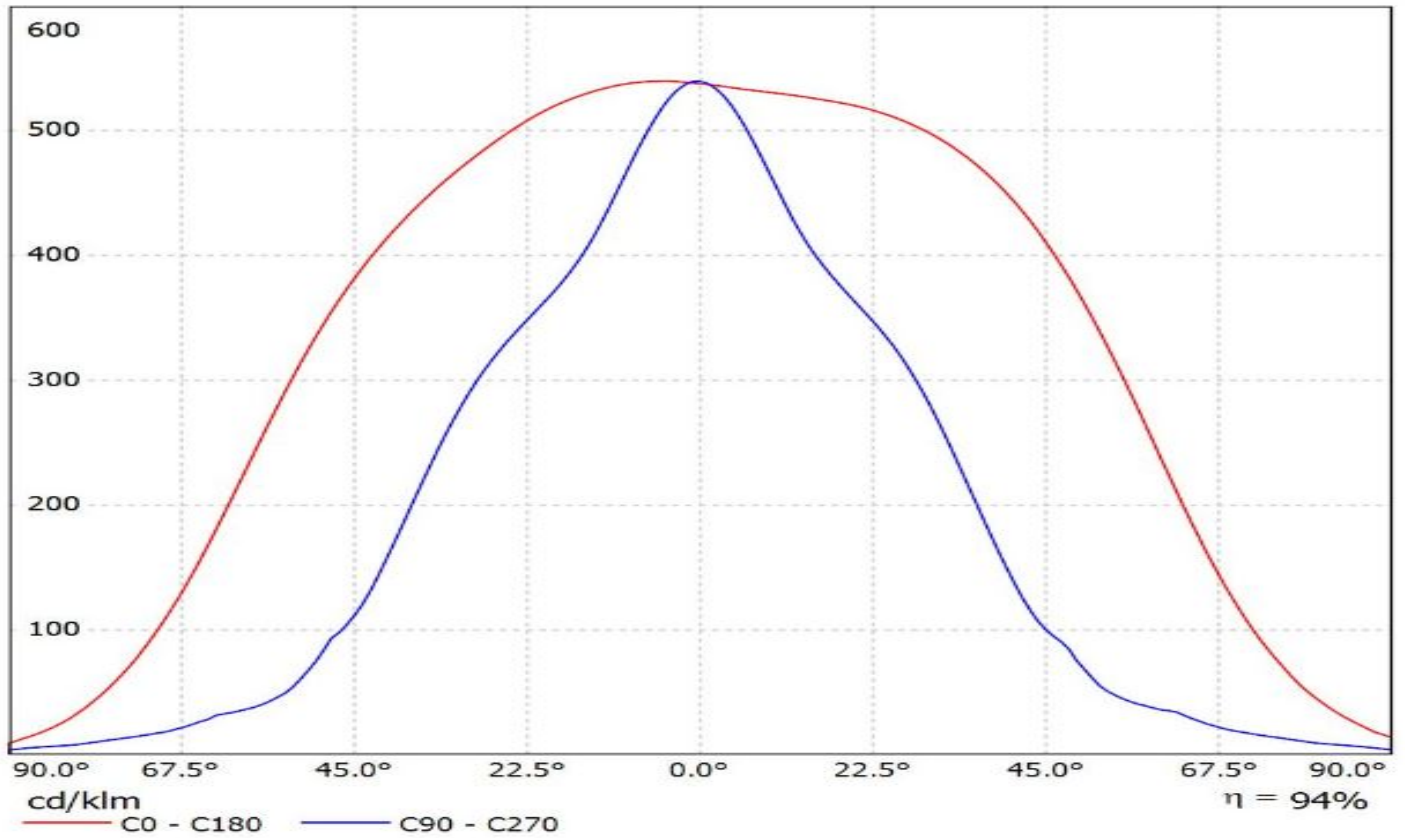

Ledil F14468_FLORENCE-1R-Z60_(Luxeon_3030_2D) / LDC (Polar)

Luminaire: Ledil F14468_FLORENCE-1R-Z60_(Luxeon_3030_2D)
Lamps: 1 x Luxeon_3030_2D_x22_(L130-4080003000W21)
_1601.44lm@200mA_CCT=4000K_P=12.8W_I=0.2A

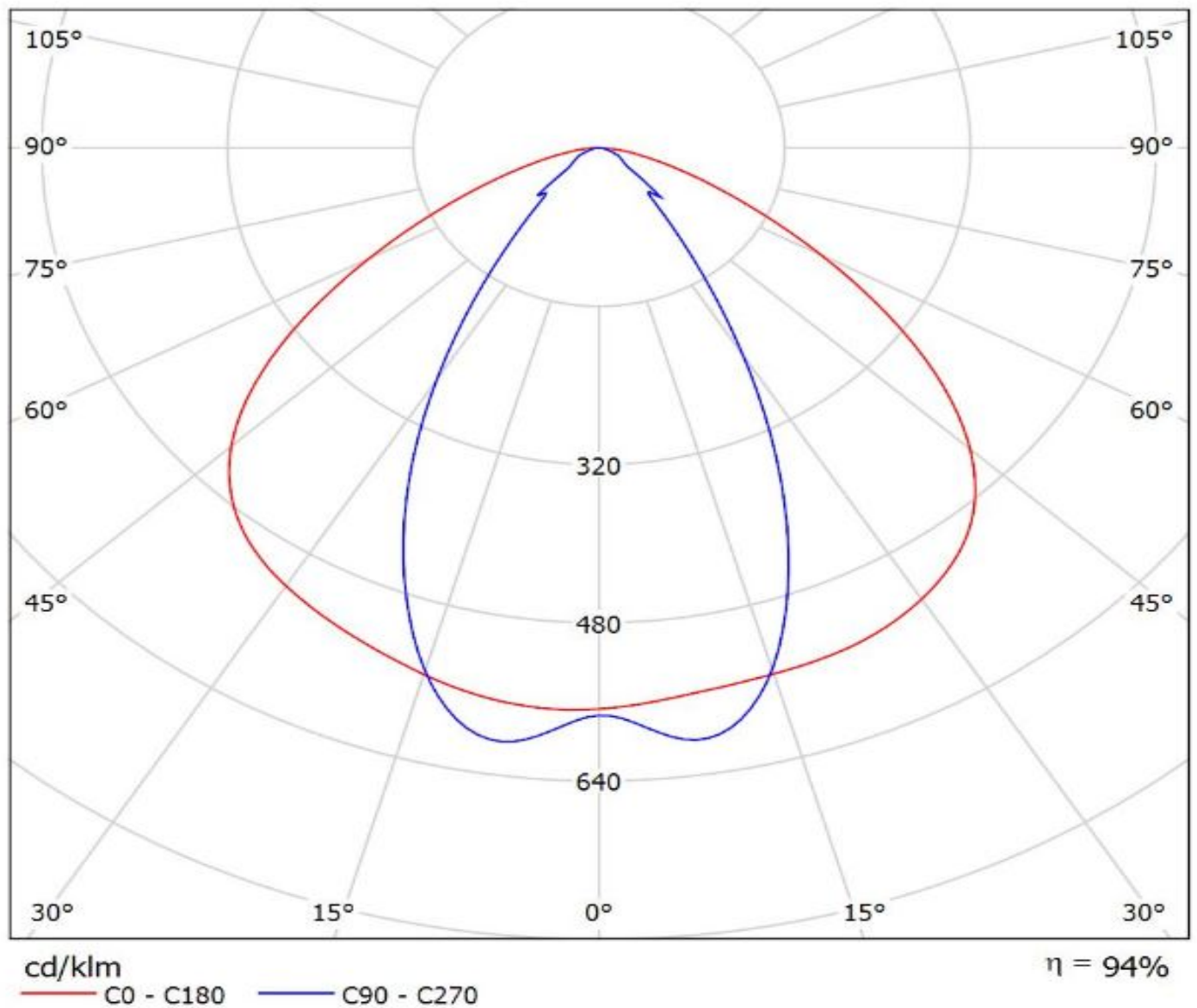

Luminaire: Ledil F14468_FLORENCE-1R-Z60_(Duris_S5)

Lamps: 1 x Osram_Duris_S5_(GW_PSLRS1.EC-LQLS-5H7I-1)_993.467lm@100mA_P=8W_I=0.1000A

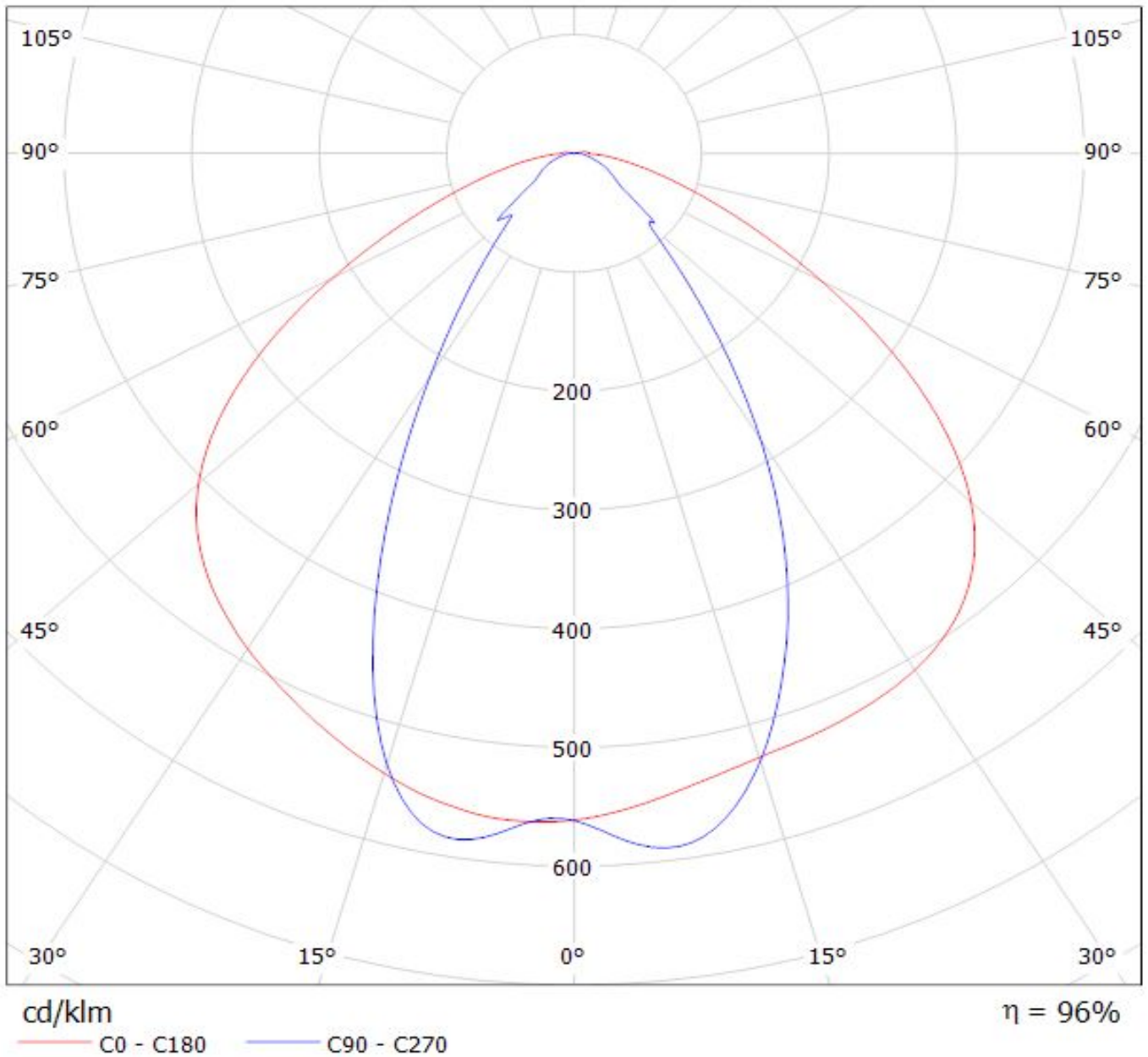

Luminaire: LEDiL Oy F14468_FLORENCE-1R-Z60 (Fortimo_LED_Line_1ft_1100lm_840_1R_LV2)_Cav4
Lamps: 1 x Fortimo_LED_Line_1ft_1100lm_840_1R_LV2_1062.24lm@250mA_P=8.02208W_I=249.8mA

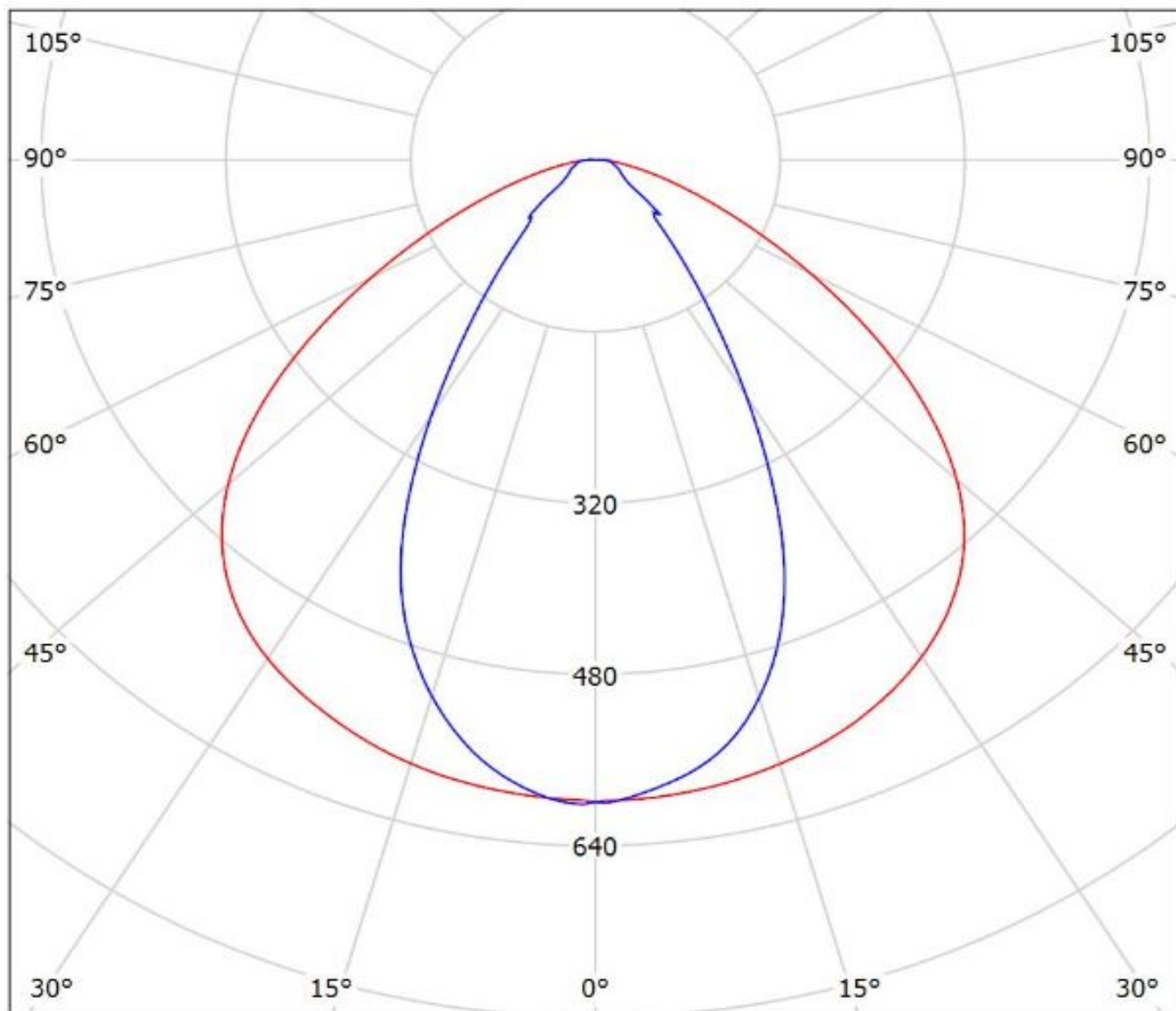

cd/klm
— C0 - C180 — C90 - C270

$\eta = 97\%$

Ledil F14468_FLORENCE-1R-Z60_(Luminus_MP-2016) / LDC (Polar)

Luminaire: Ledil F14468_FLORENCE-1R-Z60_(Luminus_MP-2016)

Lamps: 1 x Luminus_MP-2016_1x22_(LUMMP-1100-30-80)_471.904lm@120mA_P=4W_I=0.12A

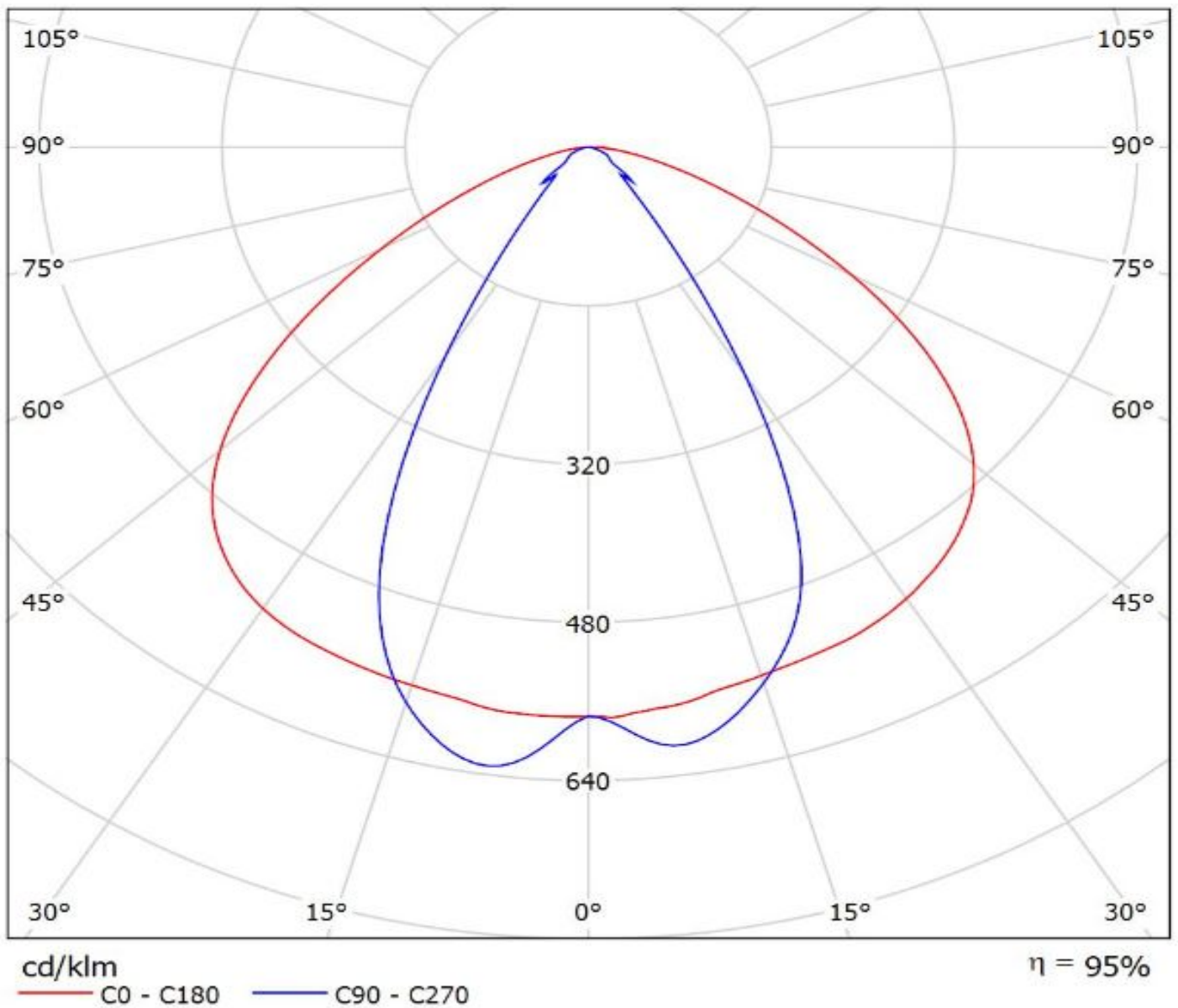

Ledil F14468_FLORENCE-1R-Z60_(NF2x757D) / LDC (Polar)

Luminaire: Ledil F14468_FLORENCE-1R-Z60_(NF2x757D)

Lamps: 1 x Nichia_NF2x757D_2chip_x22 (NF2W757DRT)_2050.61lm@200mA_P=12.95W_I=0.2A

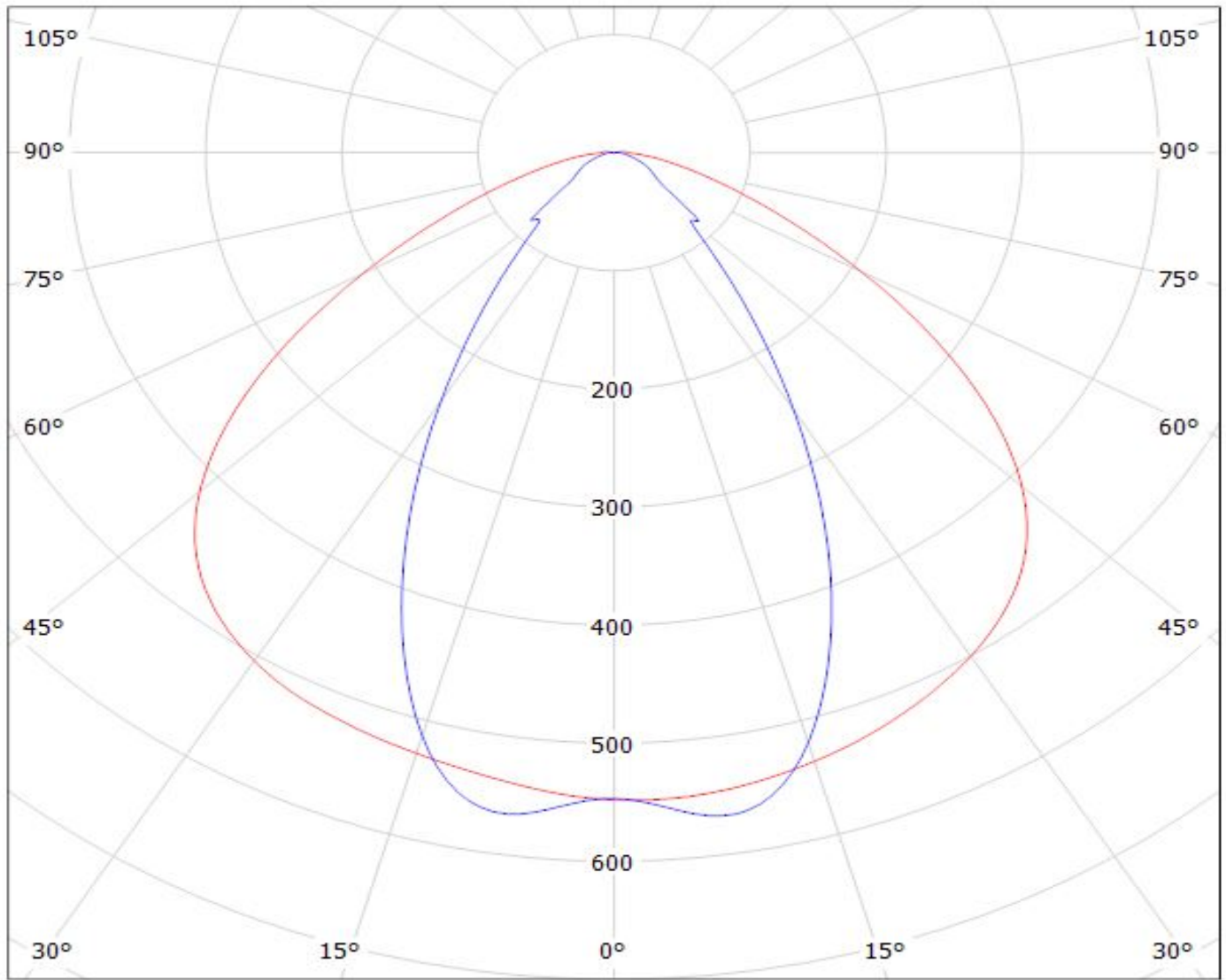

cd/klm

— C0 - C180 — C90 - C270

$\eta = 95\%$

Luminaire: LEDiL Oy F14468_FLORENCE-1R-Z60_(LM302A)

Lamps: 1 x Samsung_LM302A_865.46lm@100mA_P=6.64694W_I=0.1001A

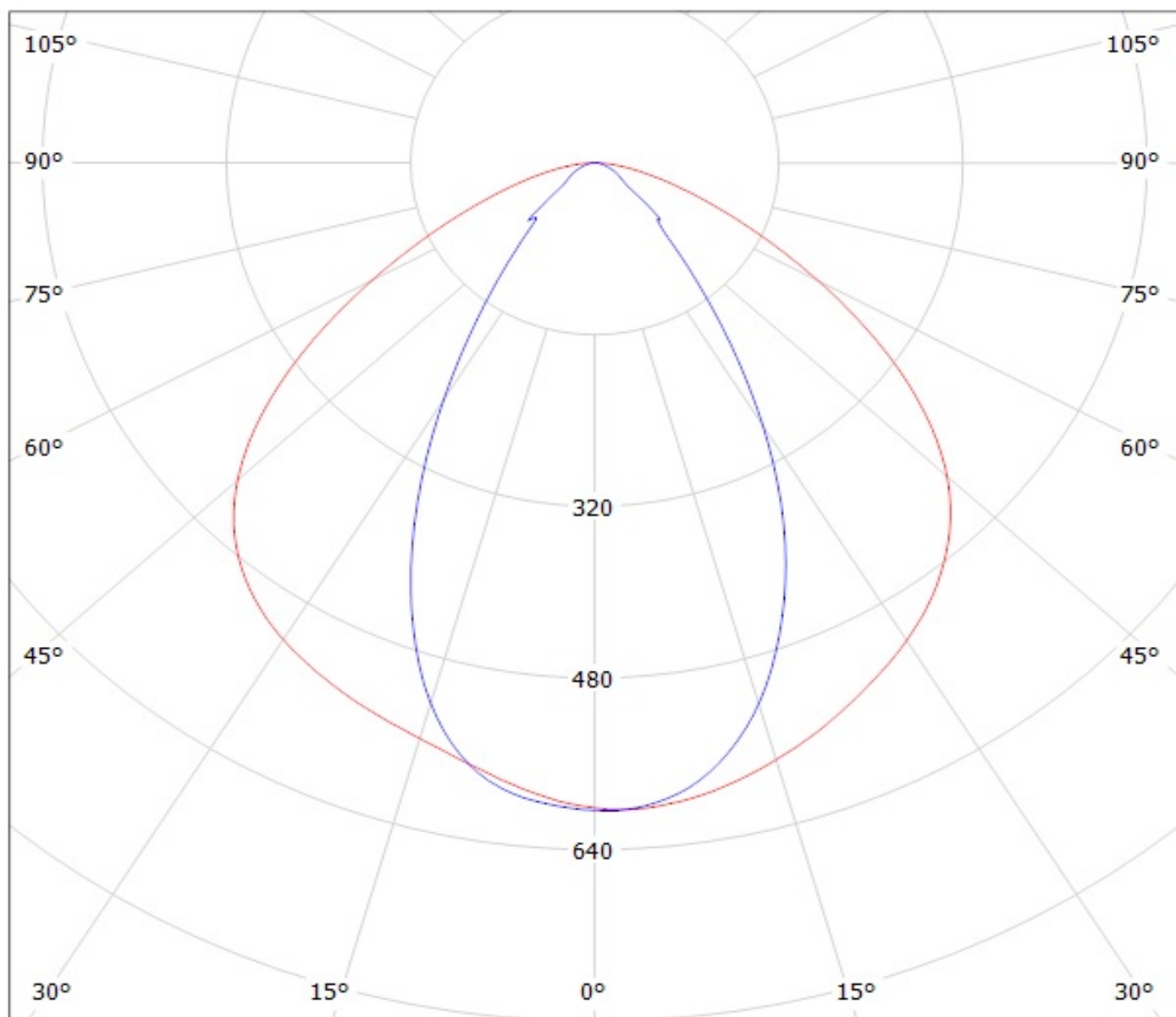

cd/klm

$\eta = 94\%$

— C0 - C180

— C90 - C270

Ledil F14468_FLORENCE-1R-Z60_(LM561B) / LDC (Polar)

Luminaire: Ledil F14468_FLORENCE-1R-Z60_(LM561B)

Lamps: 1 x Samsung_LM561B_x22_348.84lm@65mA_P=1.97W_I=65mA

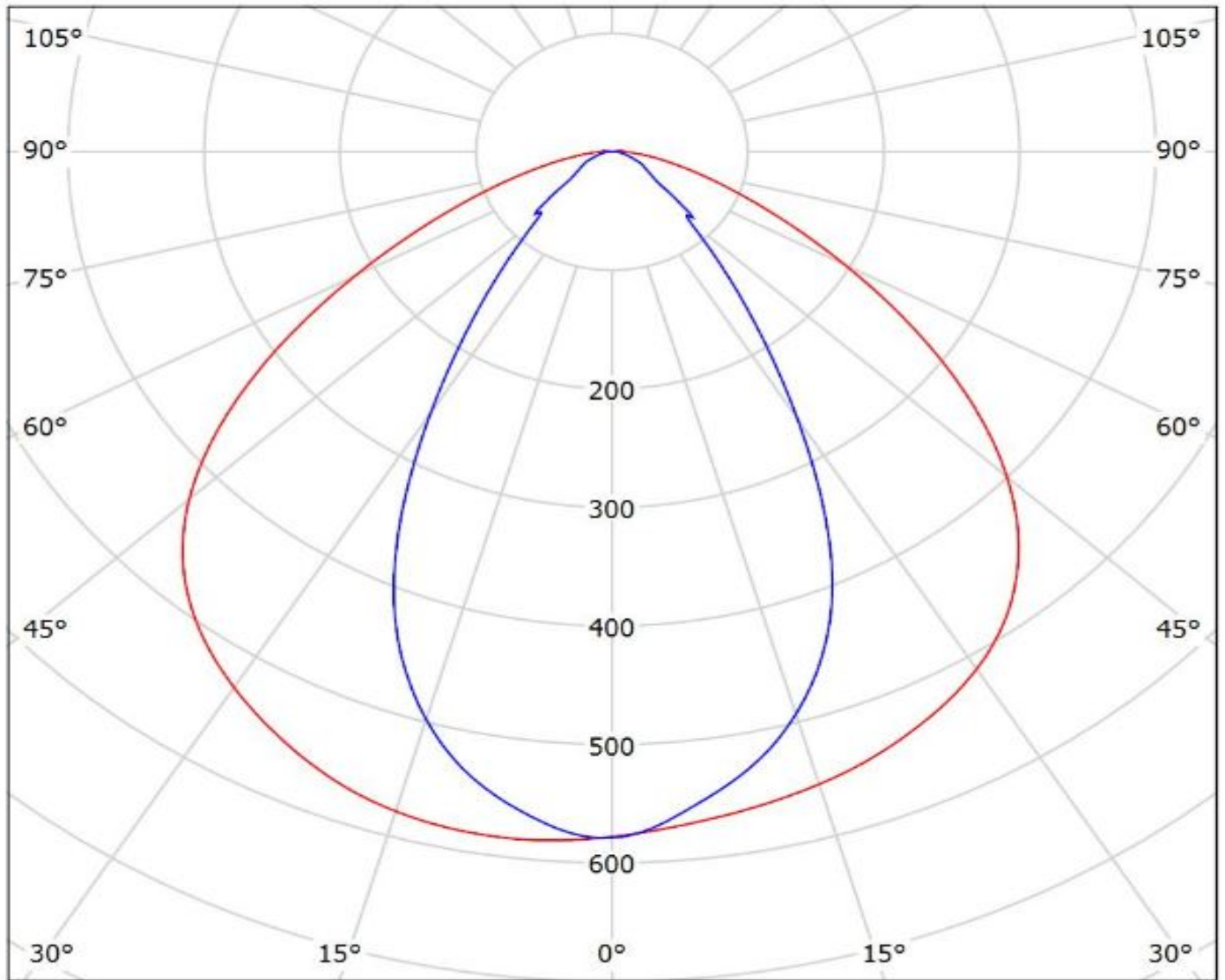

cd/klm

— C0 - C180

— C90 - C270

$\eta = 95\%$

Ledil F14468_FLORENCE-1R-Z60_(Seoul_3030) / LDC (Polar)

Luminaire: Ledil F14468_FLORENCE-1R-Z60_(Seoul_3030)

Lamps: 1 x Seoul_3030_x11_(STW8C2SA)_785.296lm@100mA_P=6.5W_I=0.1A

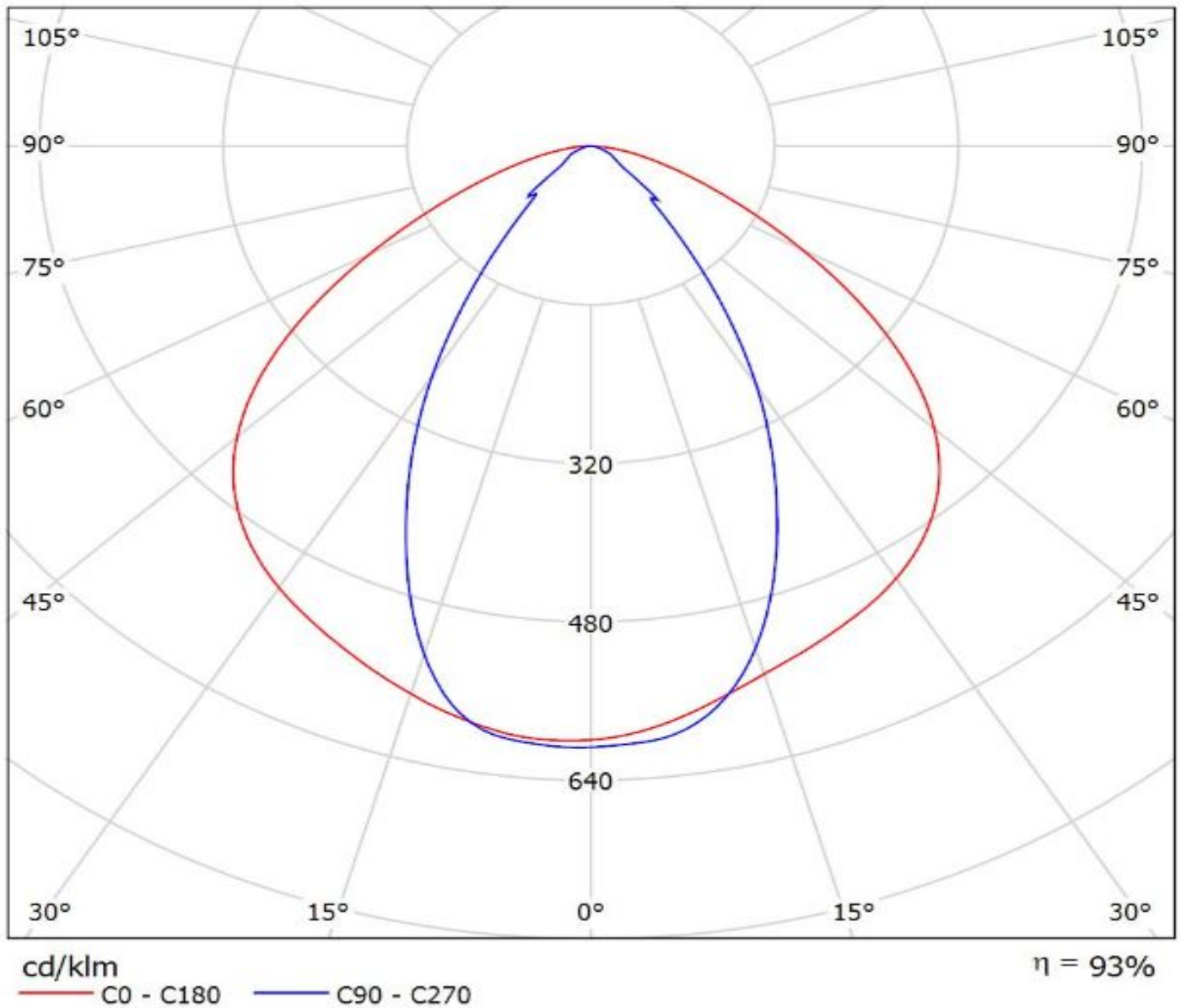

Ledil F14468_FLORENCE-1R-Z60_(Luxeon_3535_2D) / LDC (Polar)

Luminaire: Ledil F14468_FLORENCE-1R-Z60_(Luxeon_3535_2D)

Lamps: 1 x Luxeon_3535_2D_x22_(MXC8_4000K)_910.245lm@100mA_CCT=4000K_P=6.32W_I=0.1A

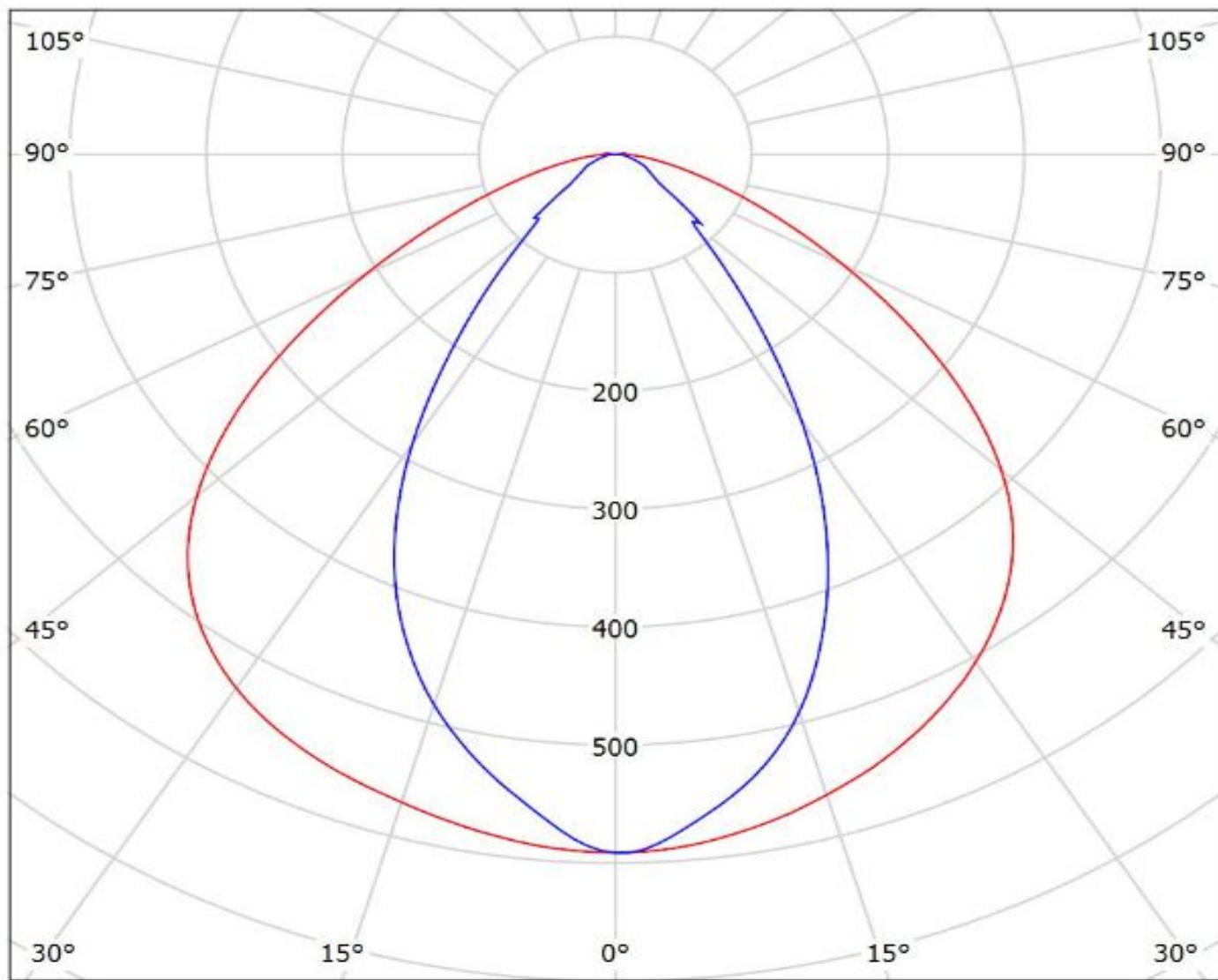

cd/klm

— C0 - C180 — C90 - C270

$\eta = 95\%$

Ledil F14468_FLORENCE-1R-Z60_(XH-B) / LDC (Polar)

Luminaire: Ledil F14468_FLORENCE-1R-Z60_(XH-B)

Lamps: 1 x Cree_XH-B_x22_(XHBAWT-0-7B4-J20-0H-0001)_315.848lm@65mA_P=2.11W_I=65mA

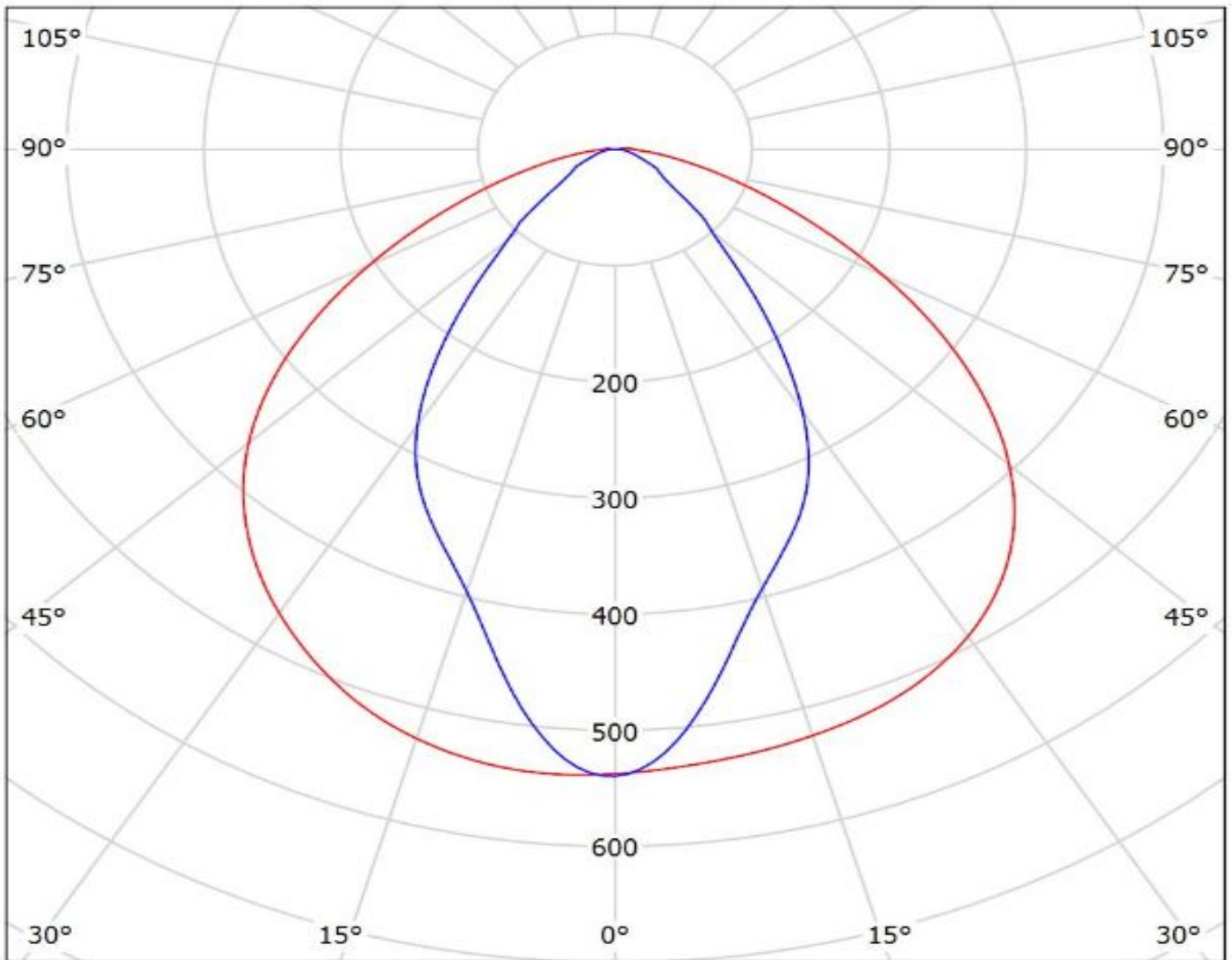

cd/klm

— C0 - C180 — C90 - C270

$\eta = 94\%$

NOTE: The typical divergence will be changed by different color, chip size and chip position tolerance. The typical total divergence is the full angle measured where the luminous intensity is half of the peak value.