

## DETAILS

<b>Product Number</b>	CN14237_WINNIE-M
<b>Family</b>	Winnie
<b>Type</b>	Assembly
<b>Color</b>	white
<b>Diameter</b>	49.8 mm
<b>Height</b>	19.3 mm
<b>Style</b>	round
<b>Optic Material</b>	PMMA
<b>Holder Material</b>	PC
<b>Fastening</b>	screw
<b>Status</b>	ready
<b>ROHS Compliant</b>	Yes
<b>Date Updated</b>	30/04/2015



## OPTICAL PROPERTIES

LED	Viewing	Light	Effi-		Connector
	Angle	Beam	ciency	cd/lm	
Luxeon CoB 105/107/109	sim: 27	Medium	sim: 86 %	sim: 2.500	-
CXM-14	sim: 49	Medium	sim: 86 %	sim: 0.930	Bender Wirth: 433 Typ L5
CXM-9	sim: 35	Medium	sim: 86 %	sim: 1.600	Bender Wirth: 434 Typ L5
ZC4/6	sim: 35	Medium	sim: 86 %	sim: 1.600	Bender Wirth: 434 Typ L5
Duris S10	24 deg	Medium	88 %	3.100	-
CXA/B 13xx	26 deg	Medium	87 %	2.800	-
CLL01x	27 deg	Medium	85 %	2.400	-
LUXEON CoB 1202s	27 deg	Medium	86 %	2.500	-
V6	27 deg	Medium	86 %	2.400	-
CLU700	27 deg	Medium	89 %	2.600	-
CLU700	28 deg	Medium	87 %	2.400	Bender Wirth: 434 Typ L5
Soleriq P6	28 deg	Medium	86 %	2.300	-
MHD-E/G	30 deg	Medium	87 %	1.900	-
V8	31 deg	Medium	85 %	1.800	-
CXA/B 15xx	31 deg	Medium	86 %	2.100	-
CLU710	32 deg	Medium	86 %	1.700	-
CLU710	33 deg	Medium	87 %	1.800	Bender Wirth: 470 Typ L5
LUXEON CoB 1202/1203	34 deg	Medium	86 %	1.700	-
Soleriq P9	34 deg	Medium	86 %	1.700	-
CLL02x/CLU024	35 deg	Medium	86 %	1.600	Bender Wirth: 434 Typ L5
CLL02x/CLU024	35 deg	Medium	87 %	2.300	-
CXM-9	36 deg	Medium	87 %	1.700	-
VERO10	36 deg	Medium	89 %	1.600	-
Soleriq S13	41 deg	Medium	85 %	1.200	-
CLU720	41 deg	Medium	90 %	1.300	Bender Wirth: 433 Typ L5

Relative intensity of CN14237\_WINNIE-M\_(Duris\_S10)

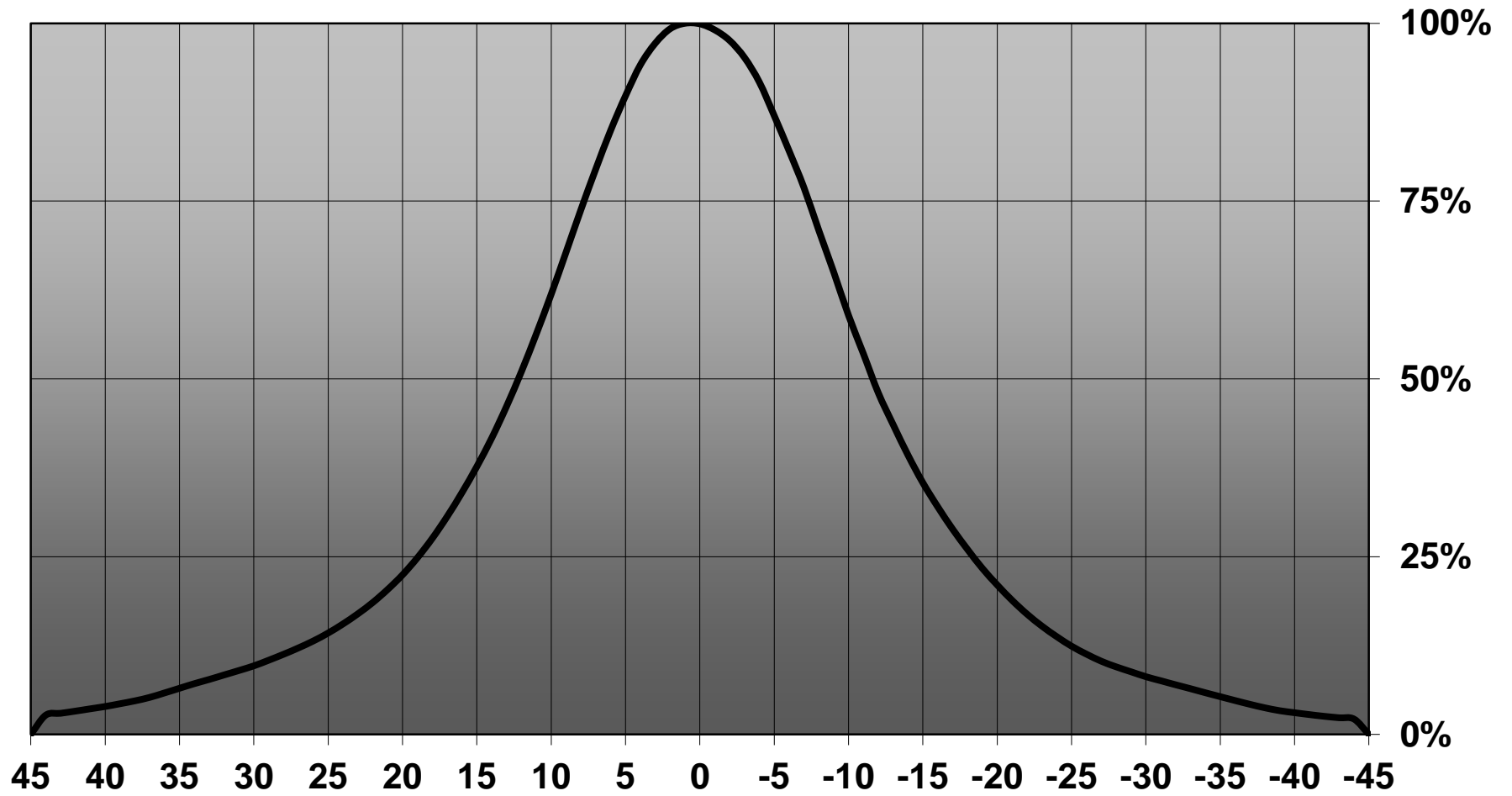

Relative intensity of CN14237\_WINNIE-M\_(CXA1304)

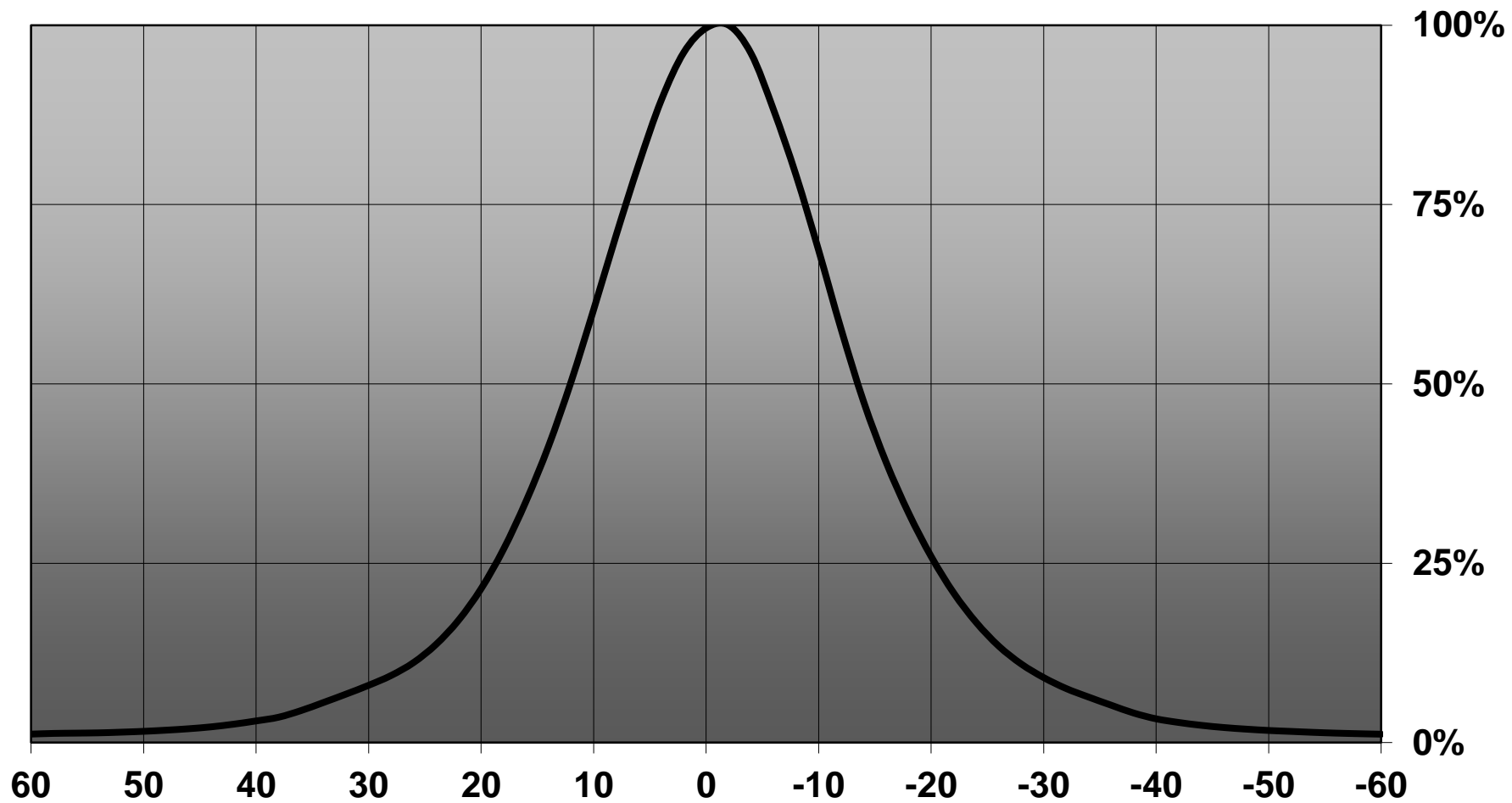

Relative intensity of CN14237\_WINNIE-M\_(CLL010)

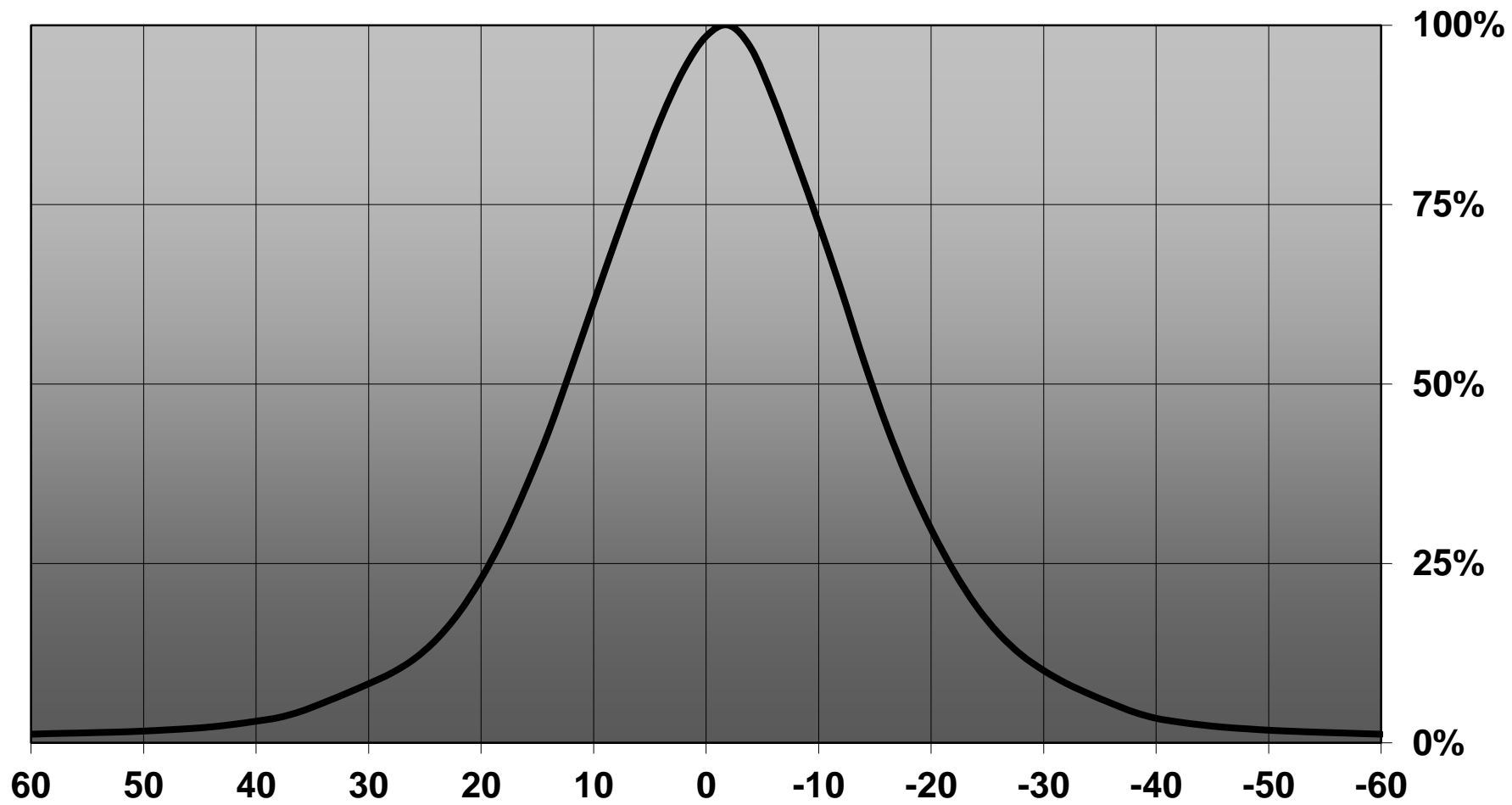

Relative intensity of CN14237\_WINNIE-M\_(CoB\_1202s)

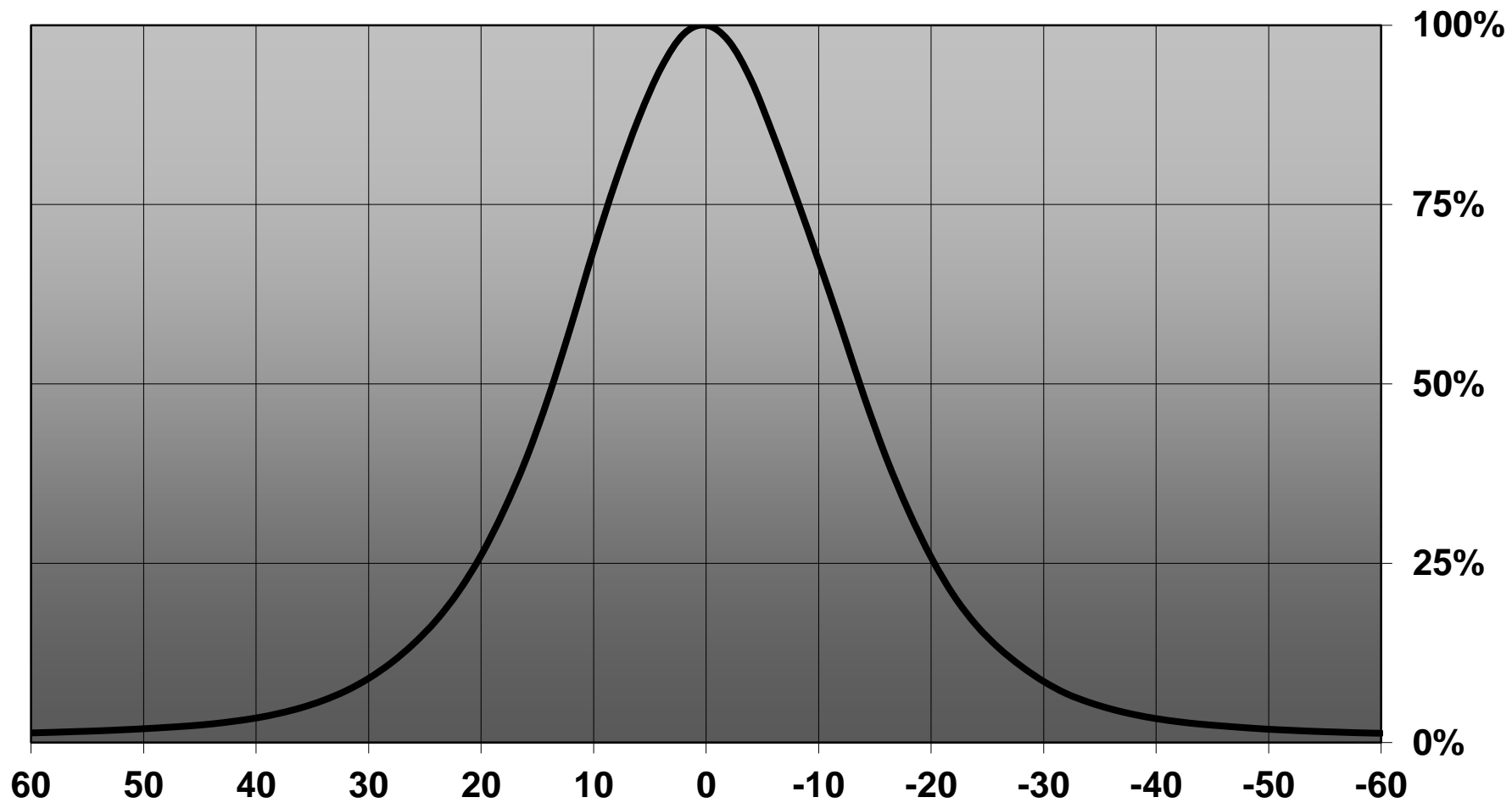

Relative intensity of CN14237\_WINNIE-M\_(V6)

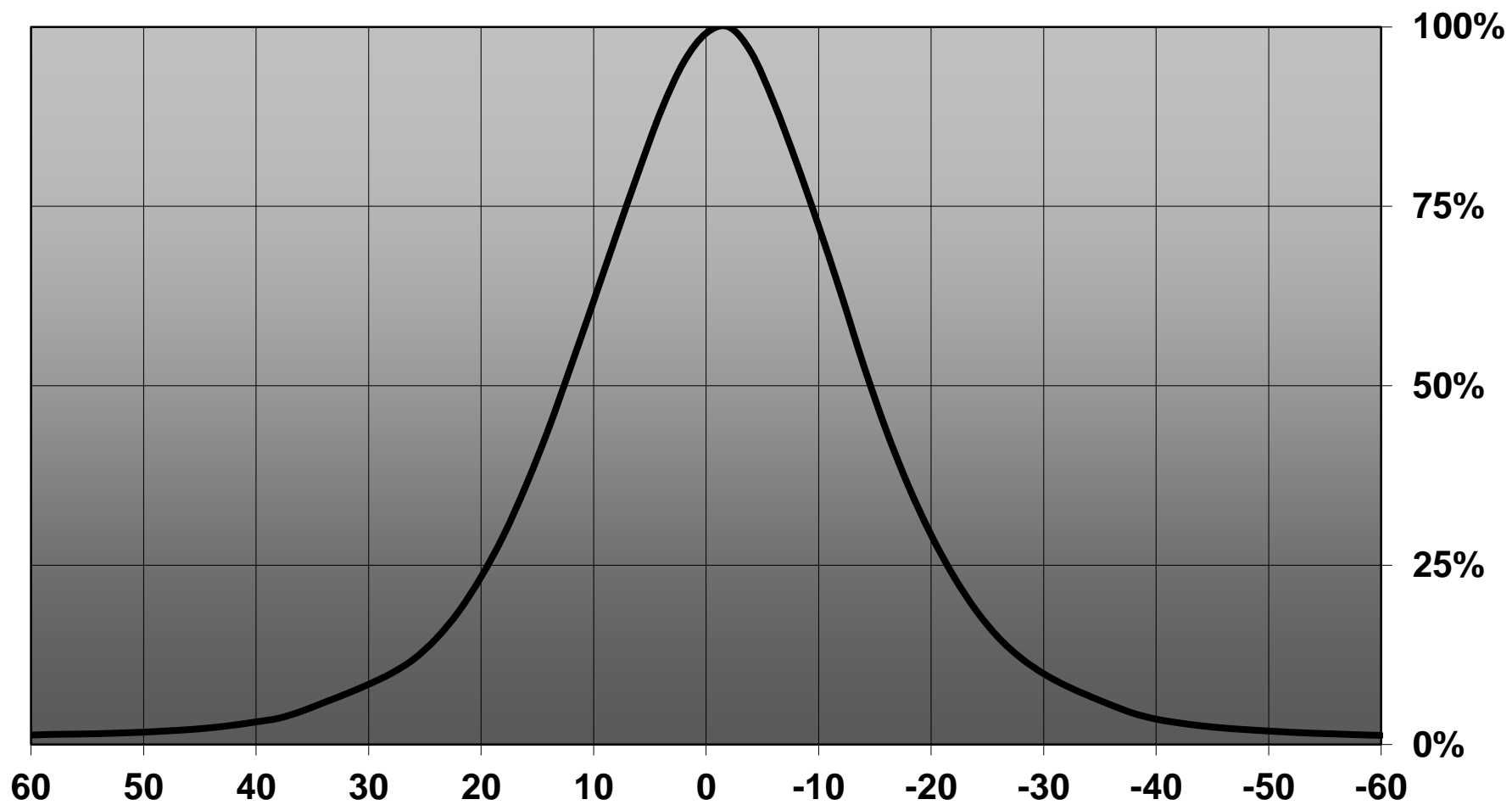

Relative intensity of CN14237\_WINNIE-M\_(Soleriq\_P6)

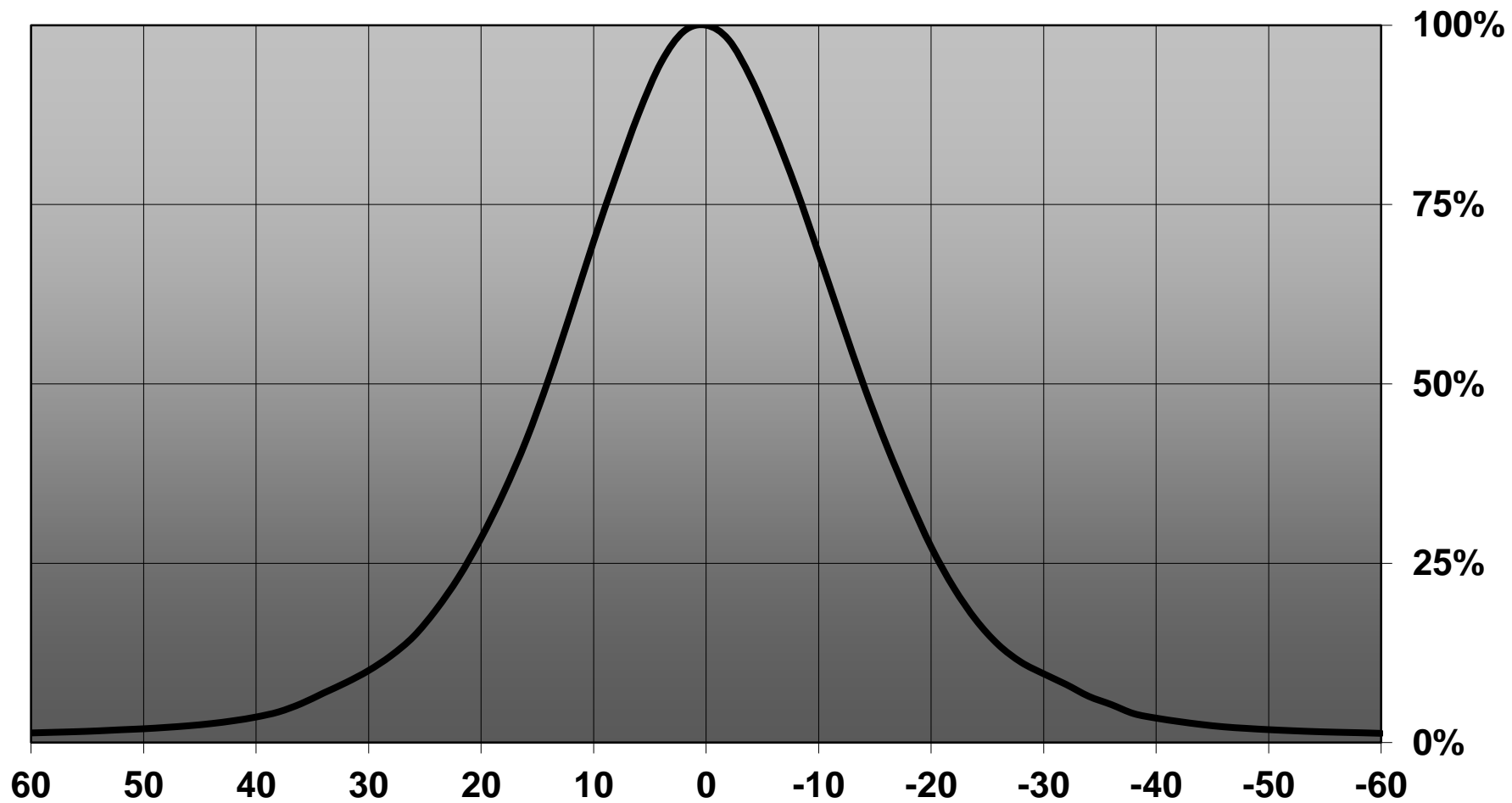

Relative intensity of CN14237\_WINNIE-M\_(V8)

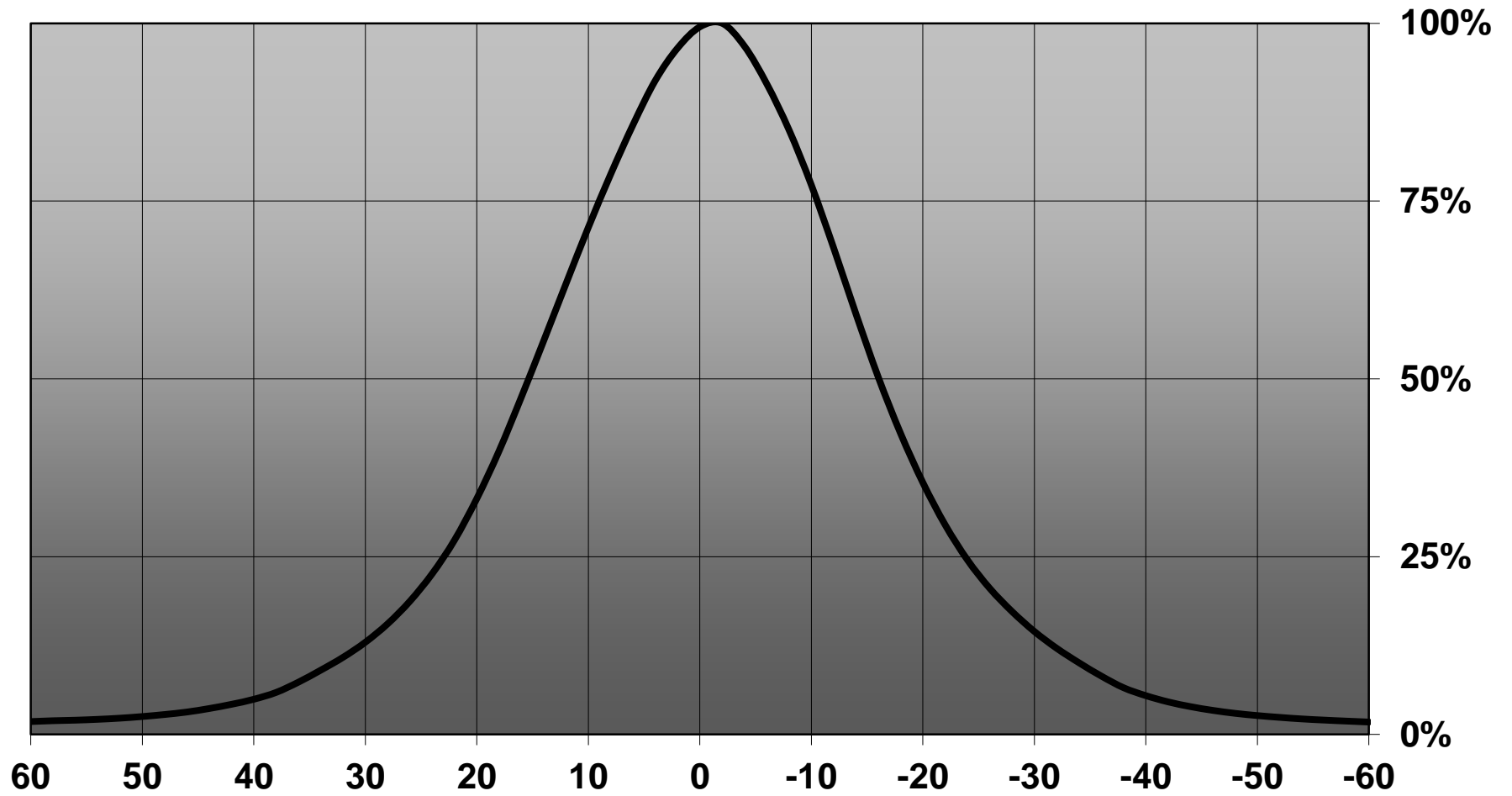

Relative intensity of CN14237\_WINNIE-M\_(CXA1520)

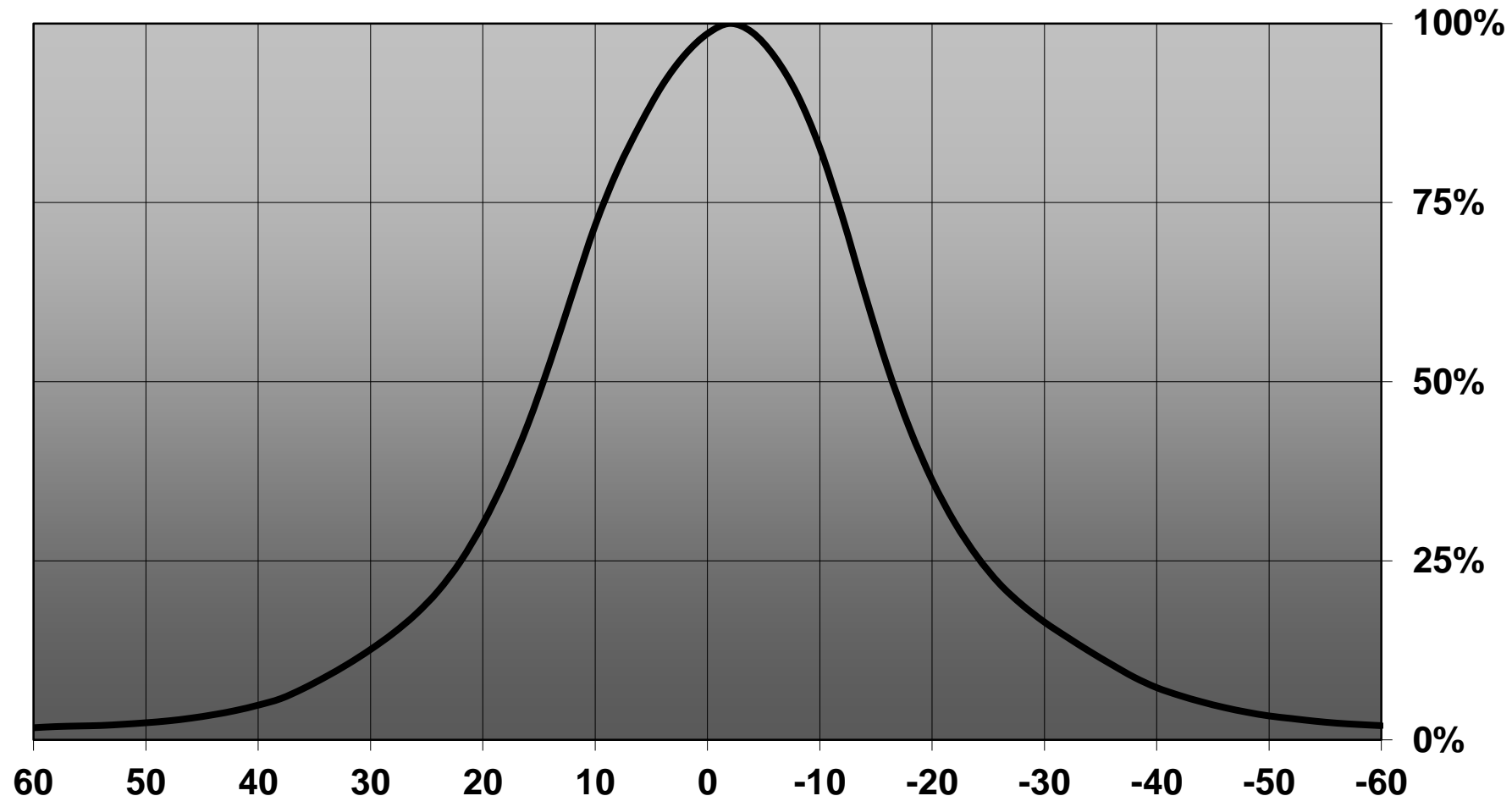

Relative intensity of CN14237\_WINNIE-M\_(COB\_1203)

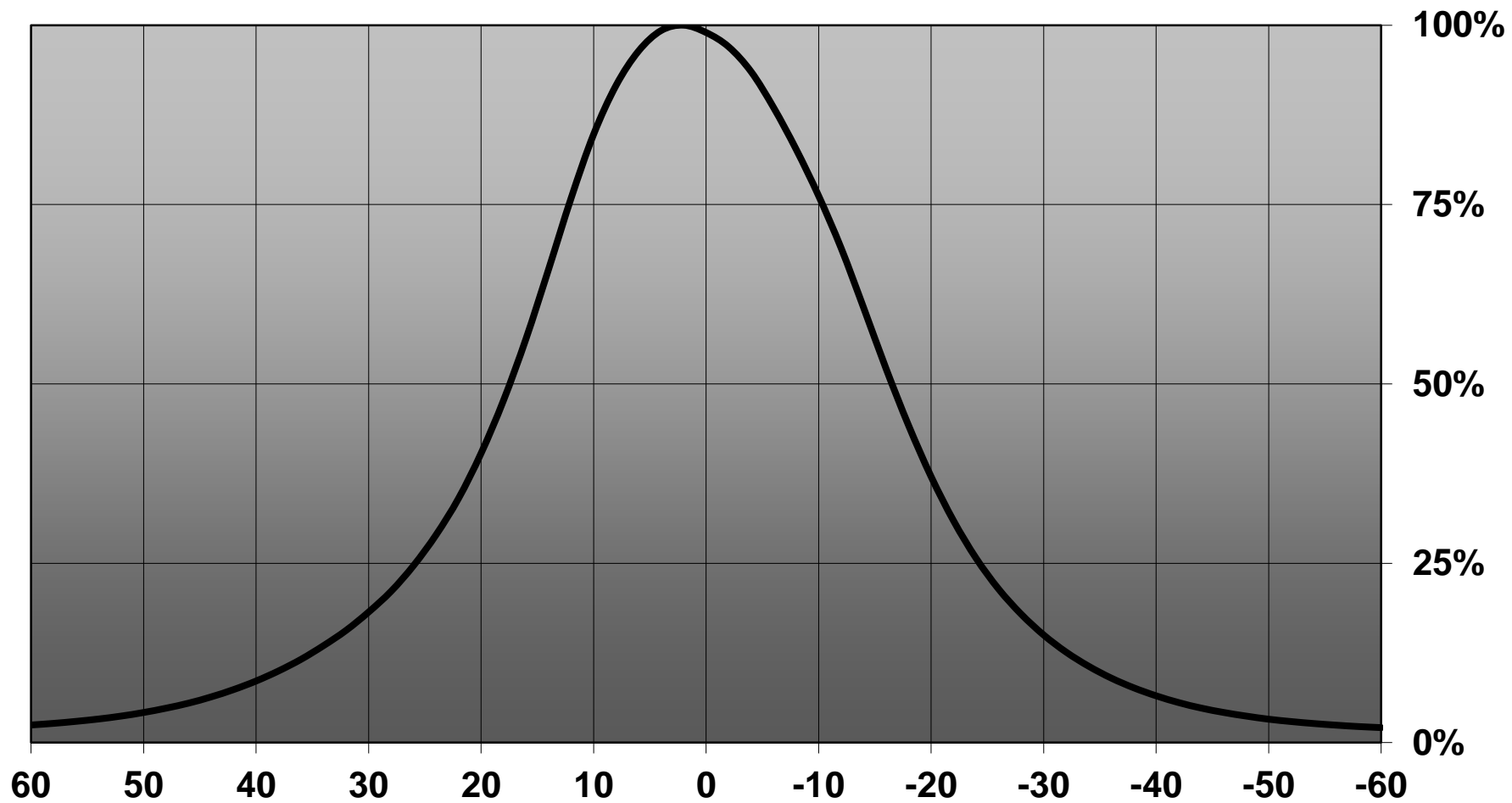

Relative intensity of CN14237\_WINNIE-M\_(Soleriq\_P9)

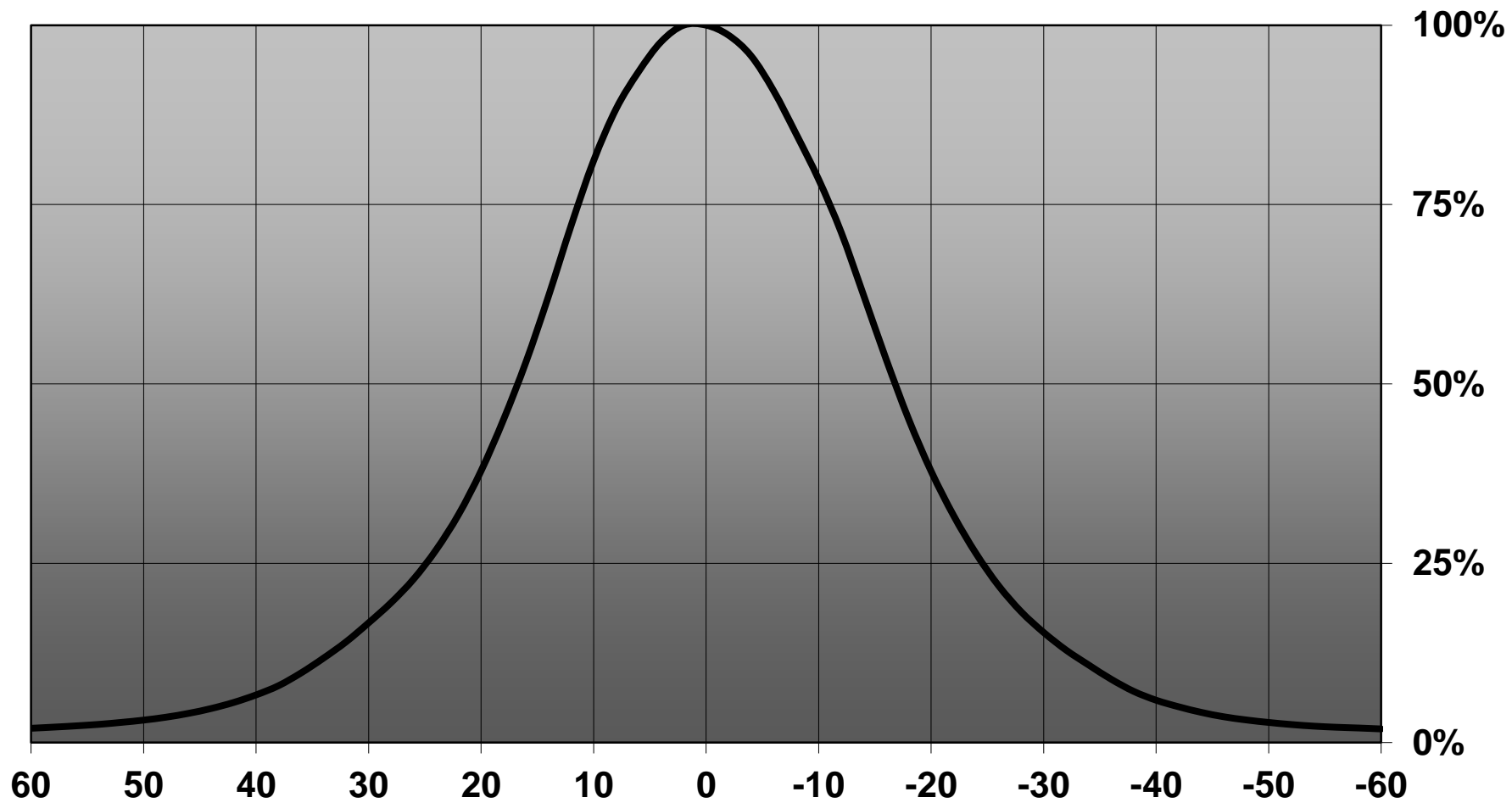

Relative intensity of CN14237\_WINNIE-M\_(CLL020)

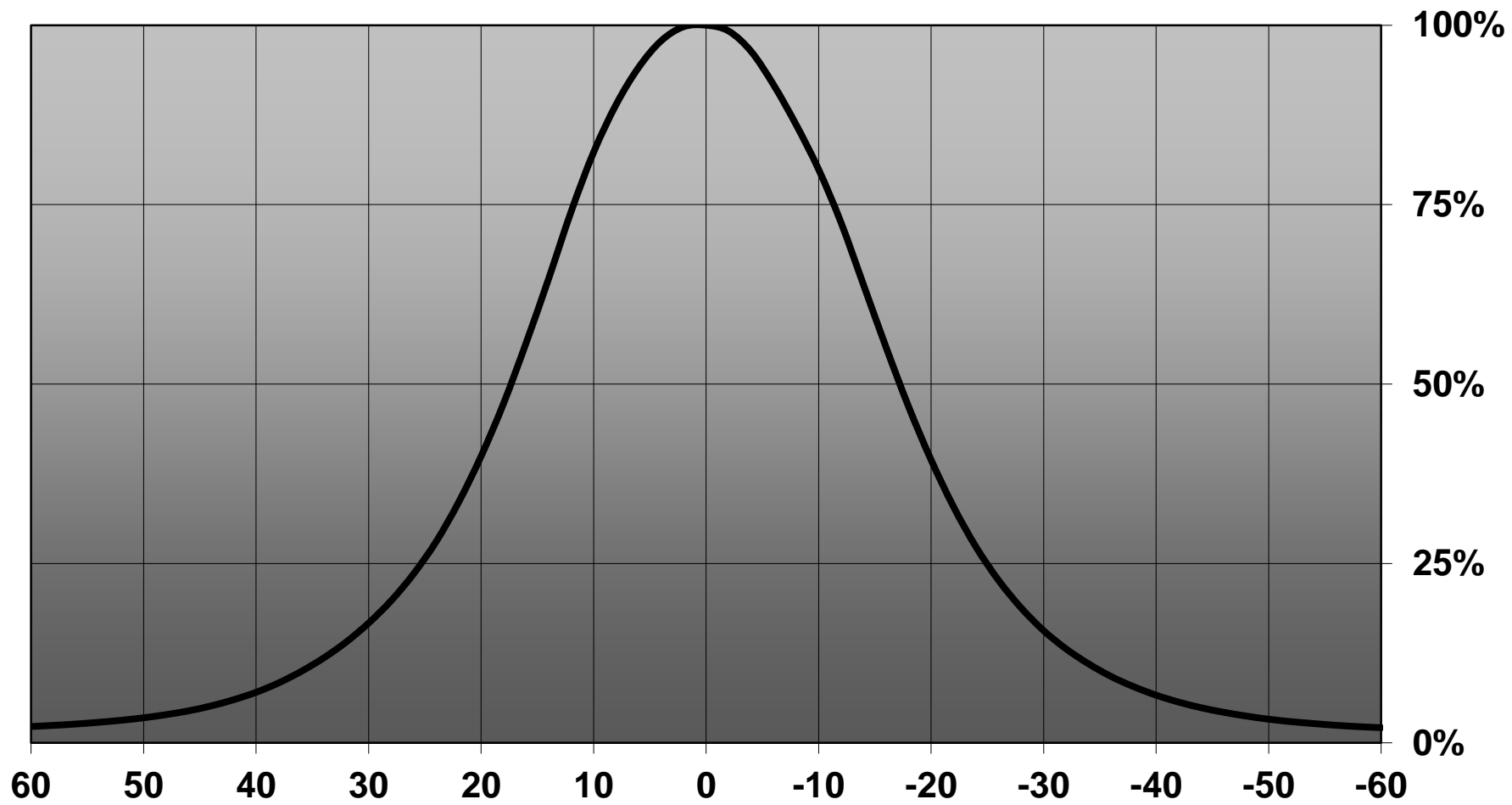

Relative intensity of CN14237\_WINNIE-M\_(CXM-9)

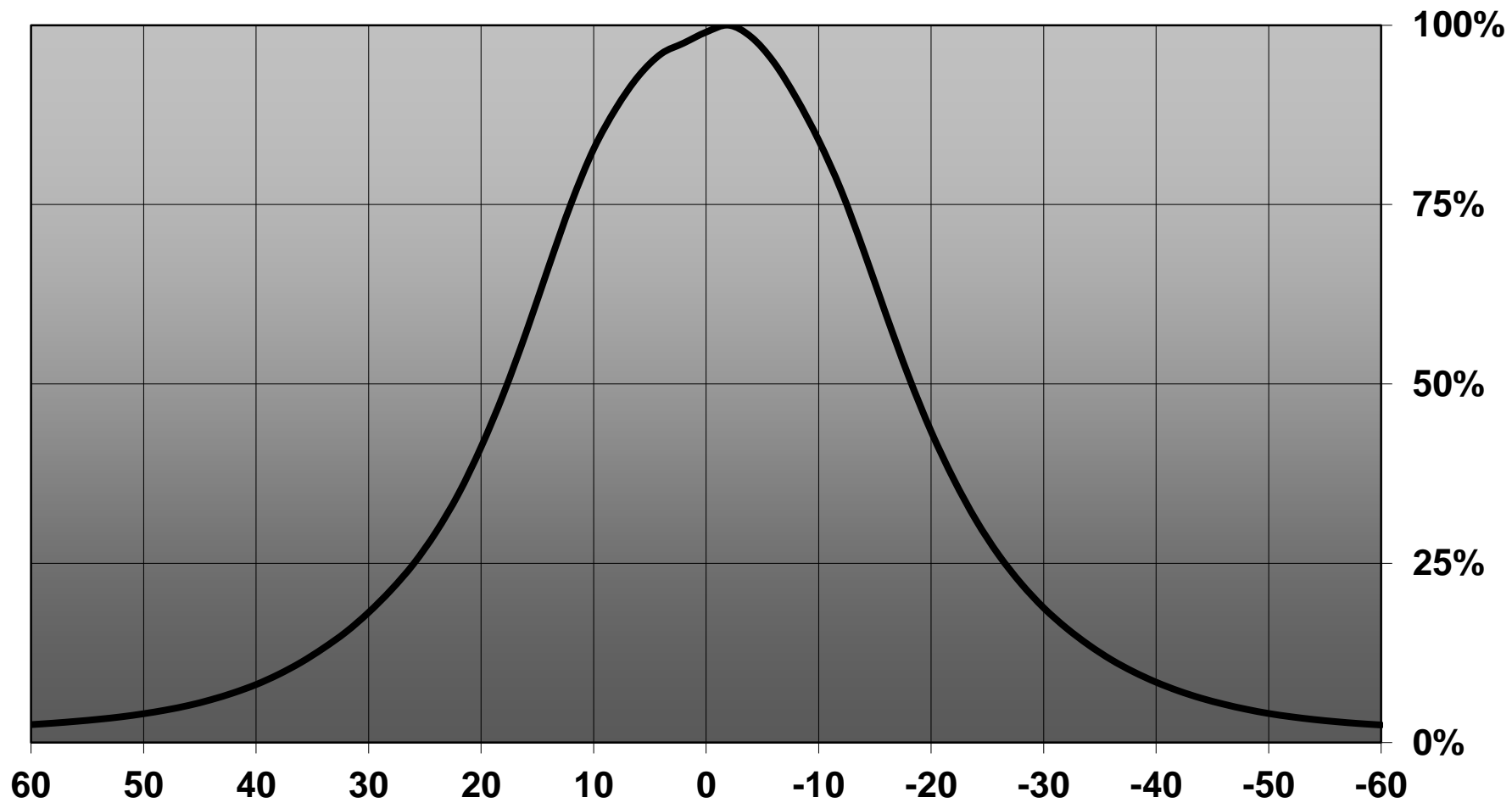

Relative intensity of CN14237\_WINNIE-M\_(Soleriq\_S13)

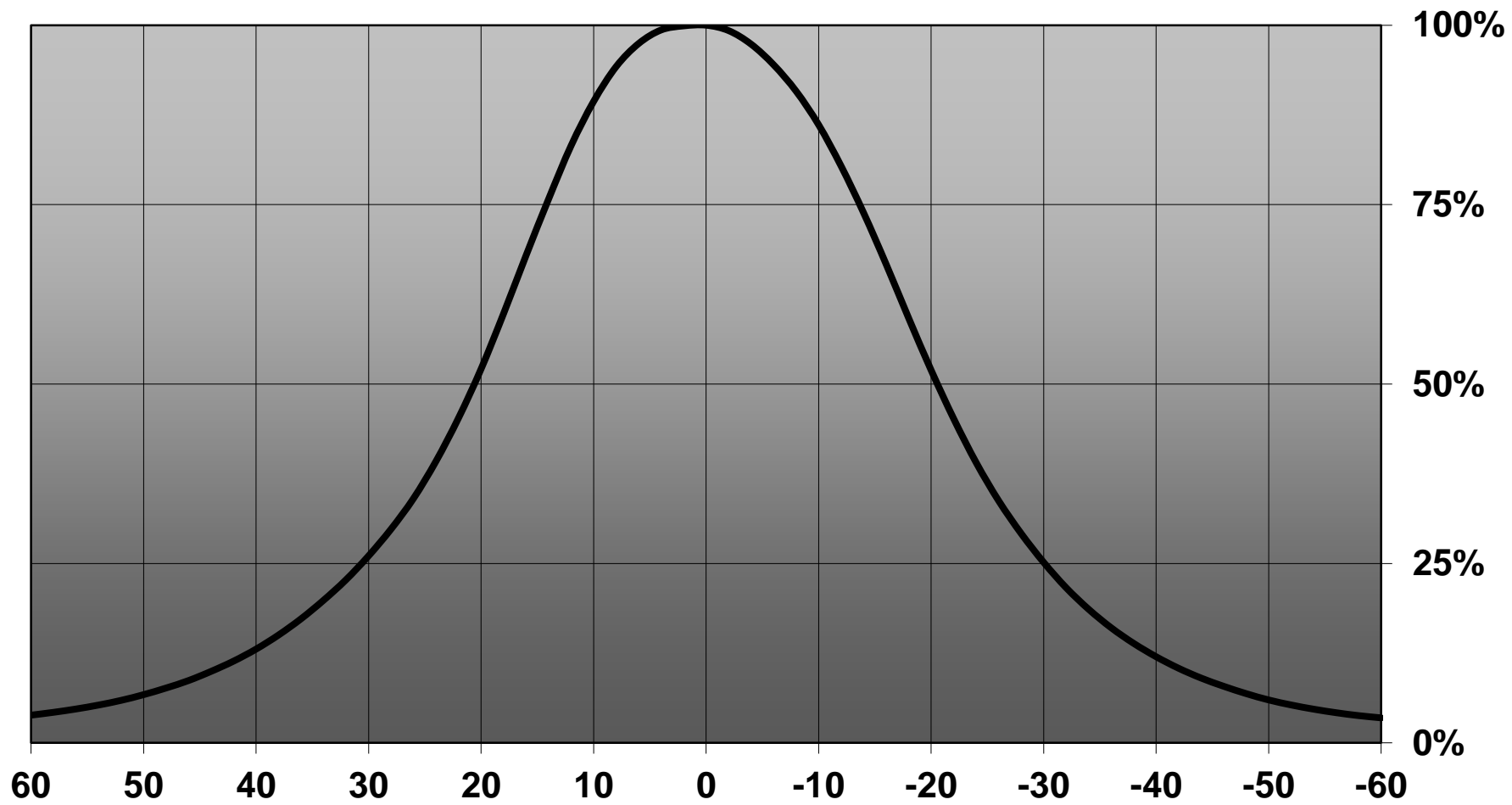

Relative intensity of CN14237\_WINNIE-M\_(CXM-14)

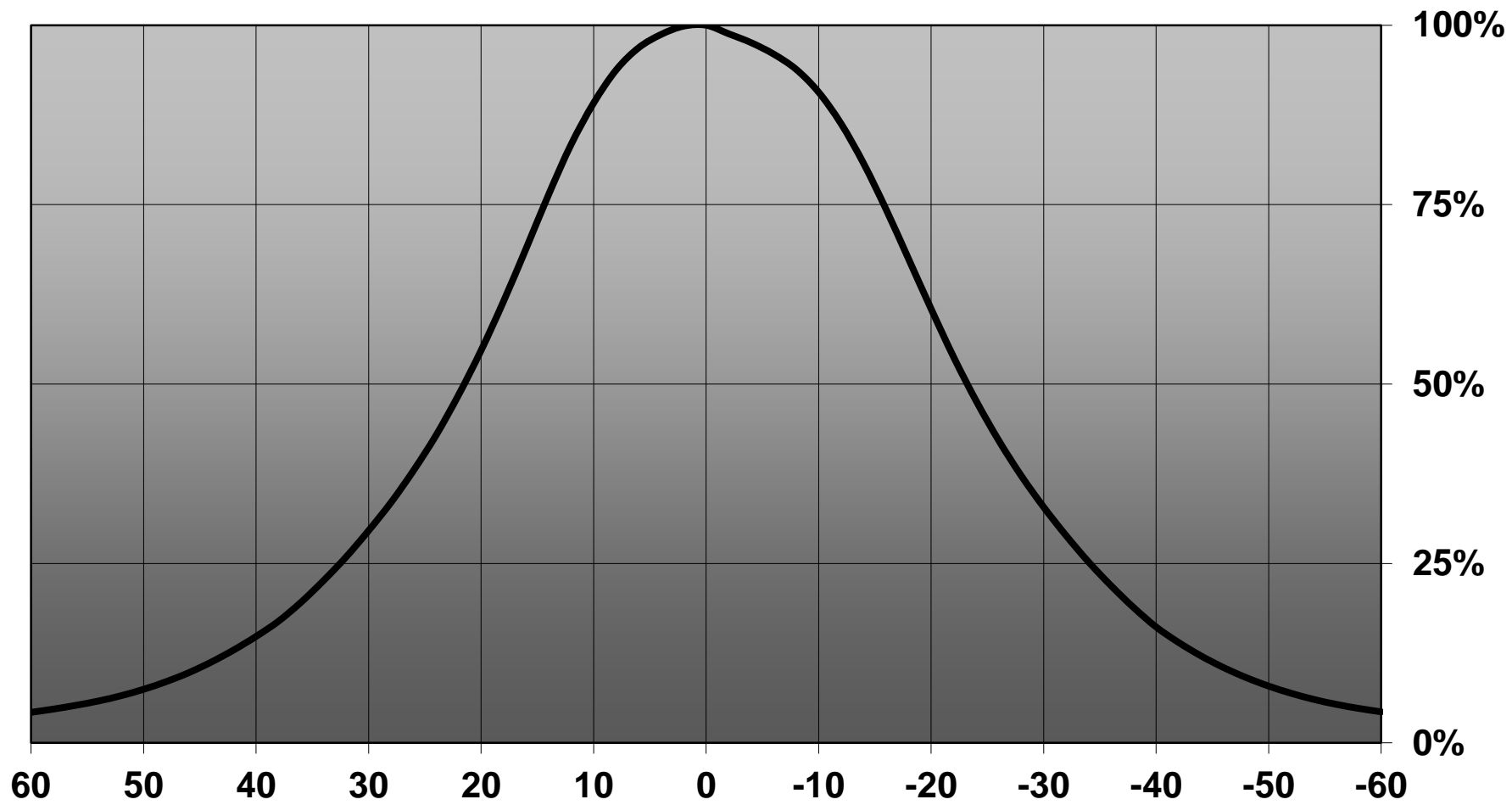

Relative intensity of CN14237\_WINNIE-M\_(Soleriq\_P13)

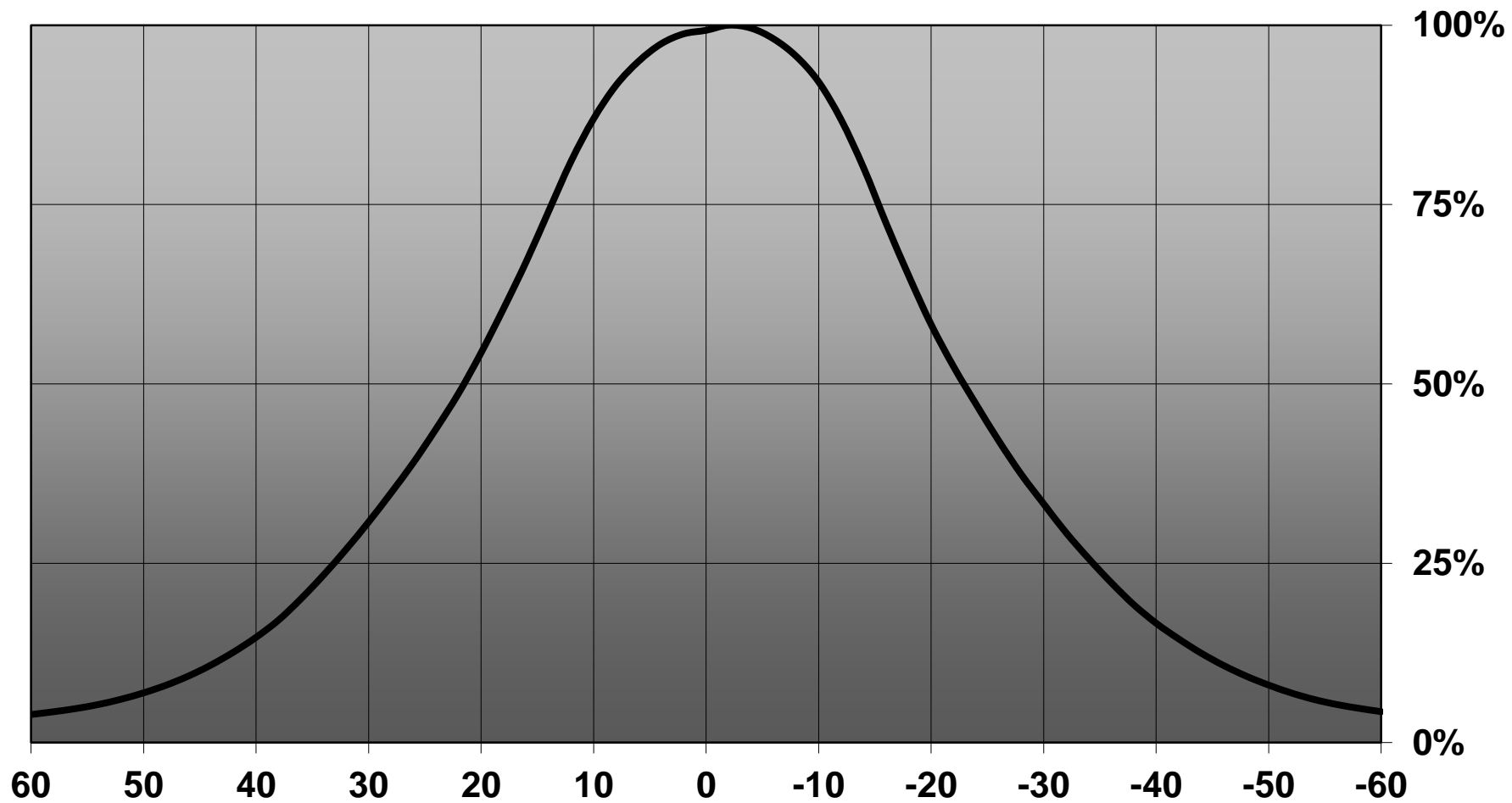

Relative intensity of CN14237\_WINNIE-M\_(Soleriq\_S19)

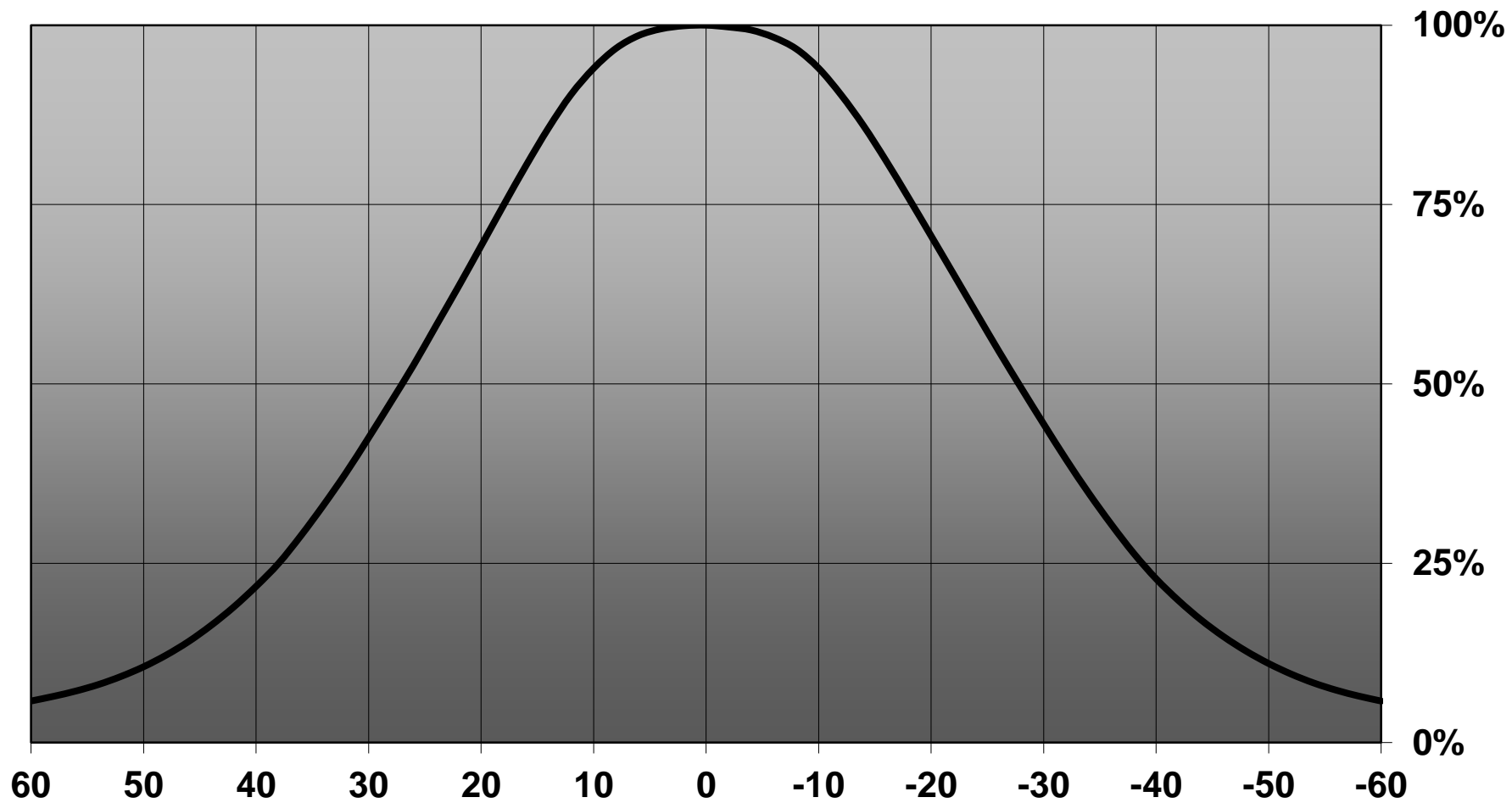

D C B A

4

4

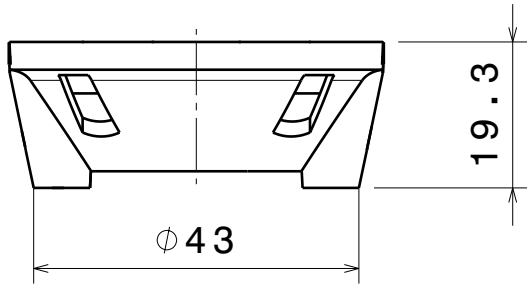

Front view

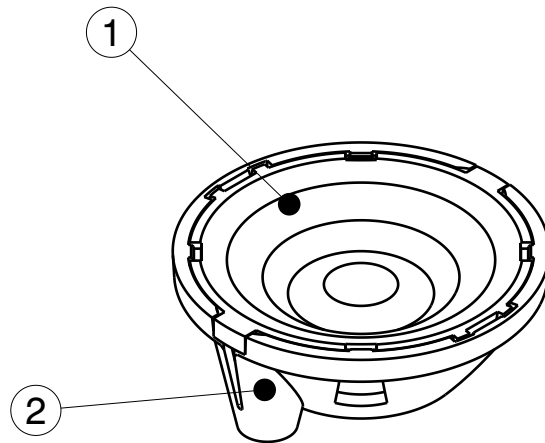

Isometric view

3

3

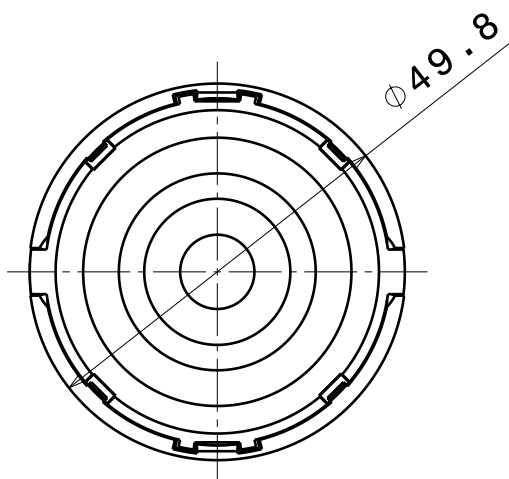

Top view

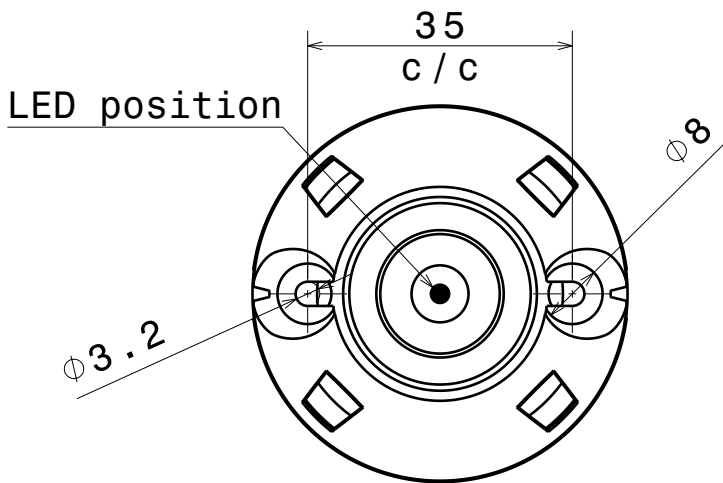

Bottom view

2

2

INDEX	PART NO	DESCRIPTION	MATERIAL	COLOUR
1	C14233	WINNIE-M	PMMA	clear
2	C14235	WINNIE-HOLDER	PC	white

Tolerances if not otherwise shown  
According to DIN ISO 2768-1  
Linear measures:  
Up to 30mm class M, otherwise class C  
According to DIN ISO 2768-2  
Form and position: class L

**LEDiL**

Ledil Oy  
Salorankatu 10  
FIN 24240 SALO  
Finland

THIRD ANGLE PROJECTION:

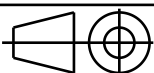

DRAWING TITLE

CN14237\_WINNIE-M

This drawing is the property of LEDiL Oy. It may not be reproduced, copied or communicated without a written agreement with LEDiL Oy.

SIZE PART NUMBER

A4

CN14237

SCALE 1:1 WEIGHT 17,74 g SHEET 1/1

1

1

D

A

Luminaire: LEDiL Oy CN14237\_WINNIE-M\_(CLU700)  
Lamps: 1 x Citizen\_CLU700\_367.467lm@100mA\_P=2.77574W\_I=0.1002A

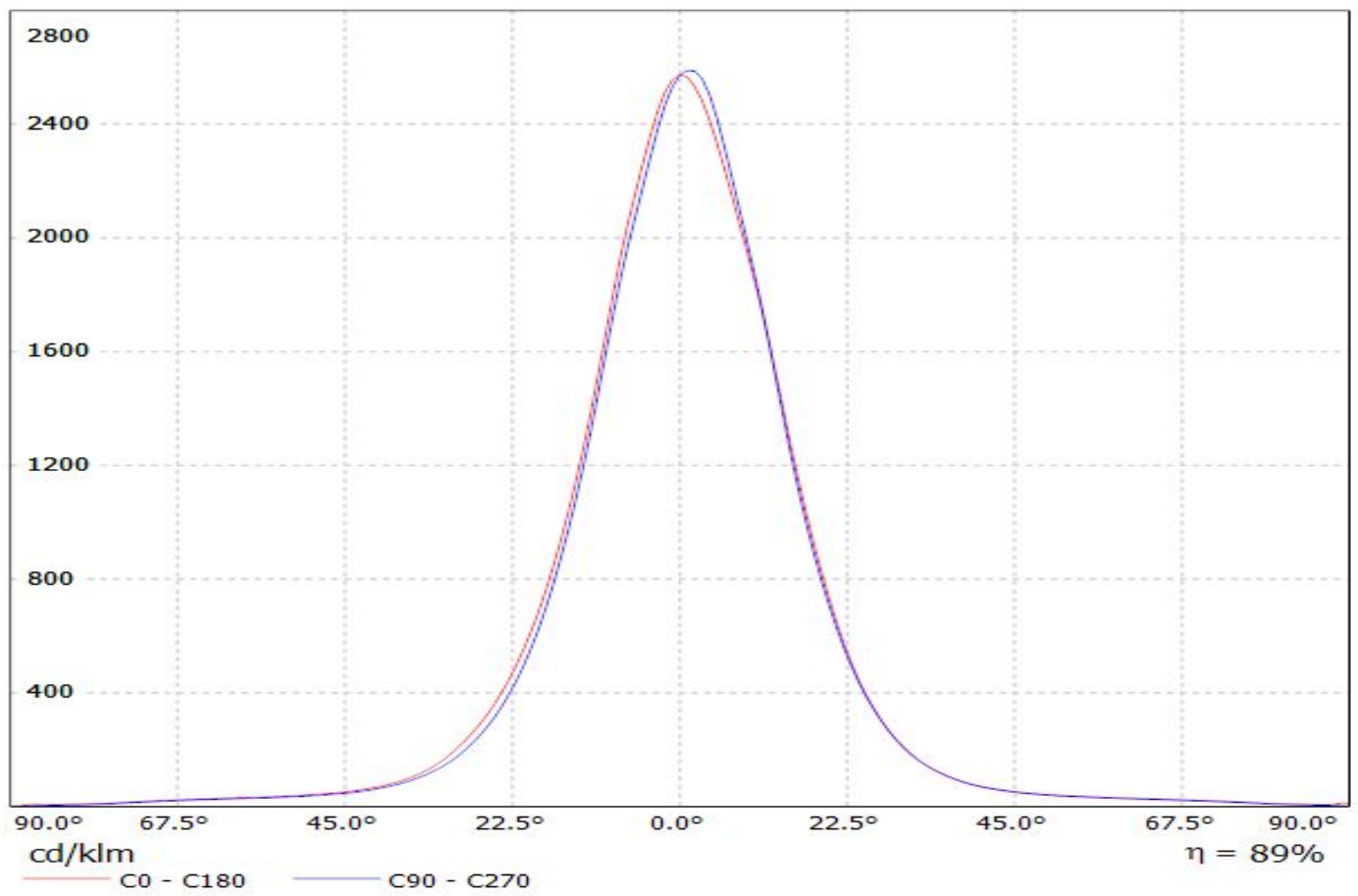

Luminaire: LEDiL Oy CN14237\_WINNIE-M\_(CLU700)\_434-Typ-L5

Lamps: 1 x Citizen\_CLU700\_(CLU700-1002B8-273M2G1)\_434\_Typ\_L5\_377.008lm@100mA\_P=2.82212W\_I=0.1001A

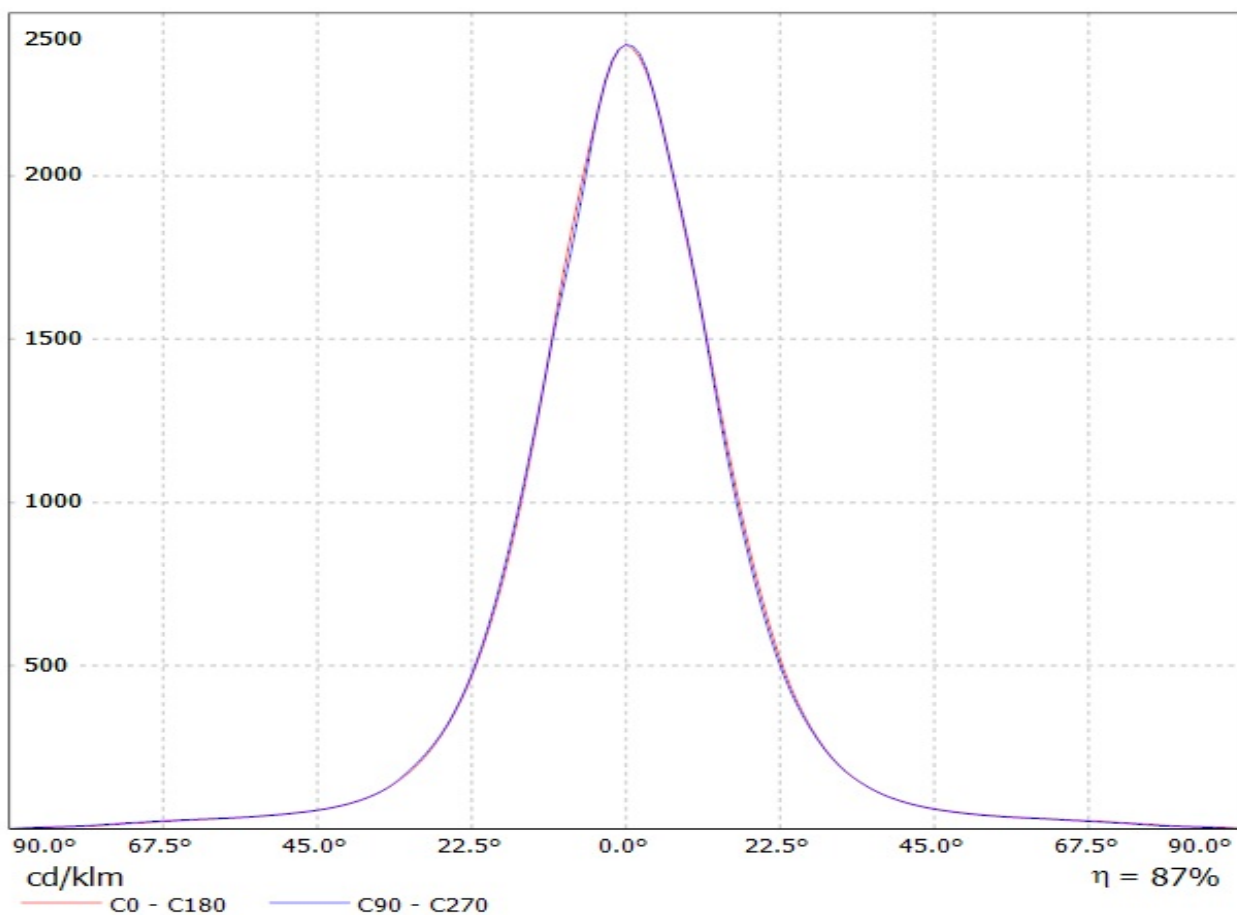

Luminaire: Ledil CN14237\_WINNIE-M\_(MHD-G)

Lamps: 1 x Cree MHD-G\_530.44lm@100mA\_P=3.0W\_I=0.100A

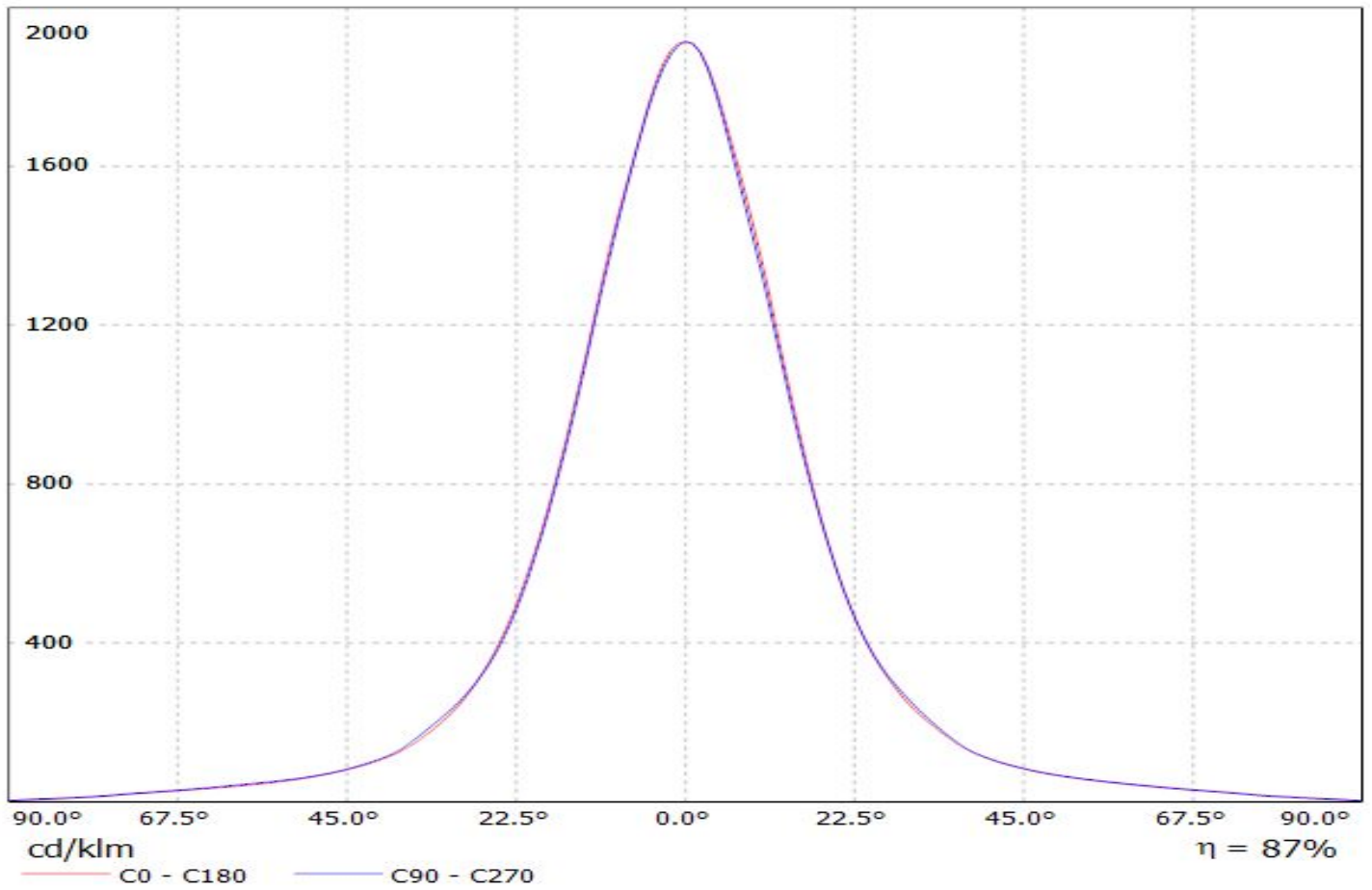

# Ledil CN14237\_WINNIE-M\_(CLU710) / LDC (Linear)

Luminaire: Ledil CN14237\_WINNIE-M\_(CLU710)

Lamps: 1 x CITIZEN\_CLU710\_(CLU710-1204B8-273M2G1)\_1210.56lm@250mA\_P=8.5W\_I=0.25A

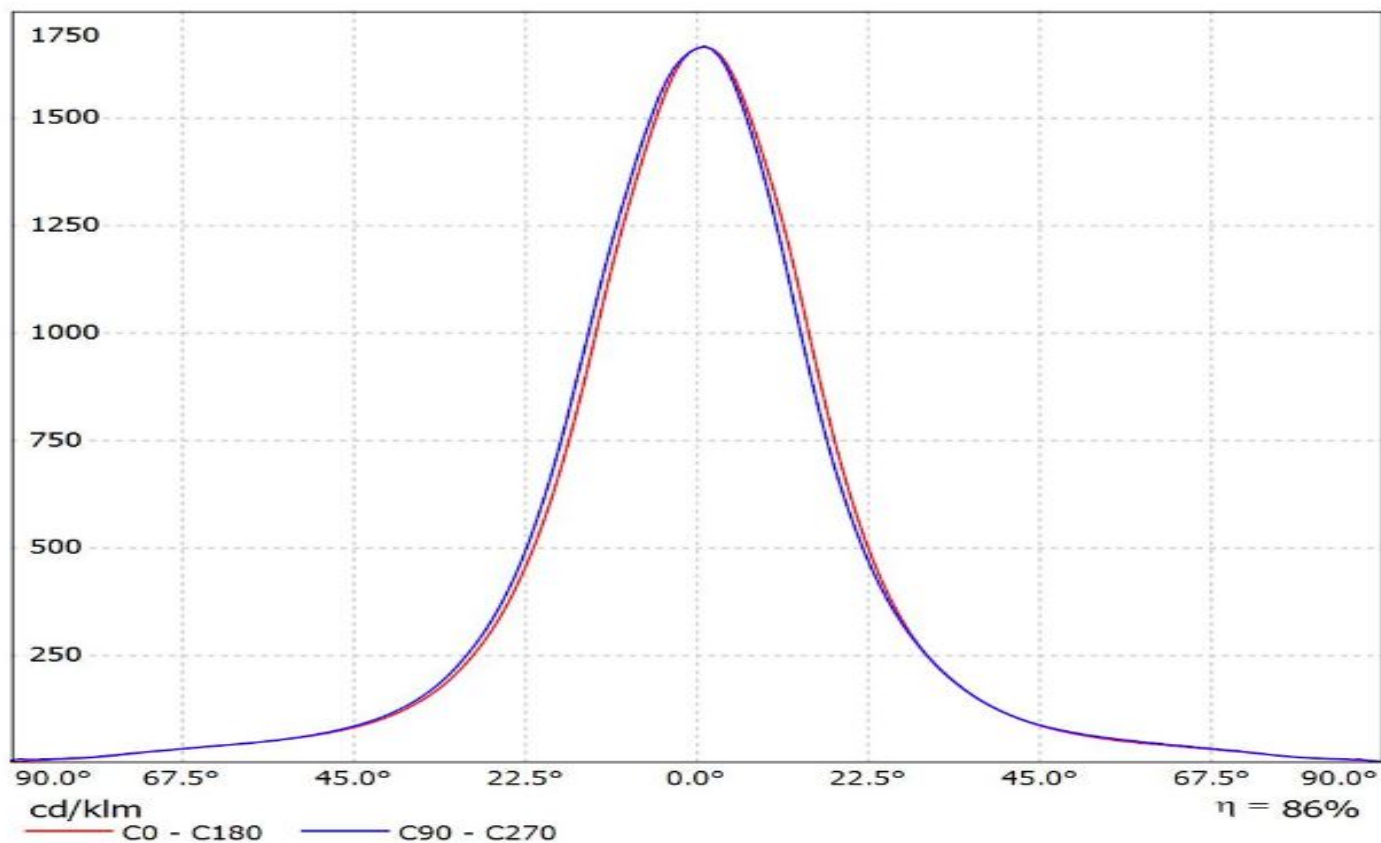

# Ledil CN14237\_WINNIE-M\_(CLU710)\_(470\_Typ\_L5) / LDC (Linear)

Luminaire: Ledil CN14237\_WINNIE-M\_(CLU710)\_(470\_Typ\_L5)  
Lamps: 1 x Citizen\_CLU710\_(CLU710-1204B8-273M2G1)\_(470\_Typ\_L5)  
\_1134.69lm@250mA\_CCT=2700K\_P=8.5W\_I=0.25A

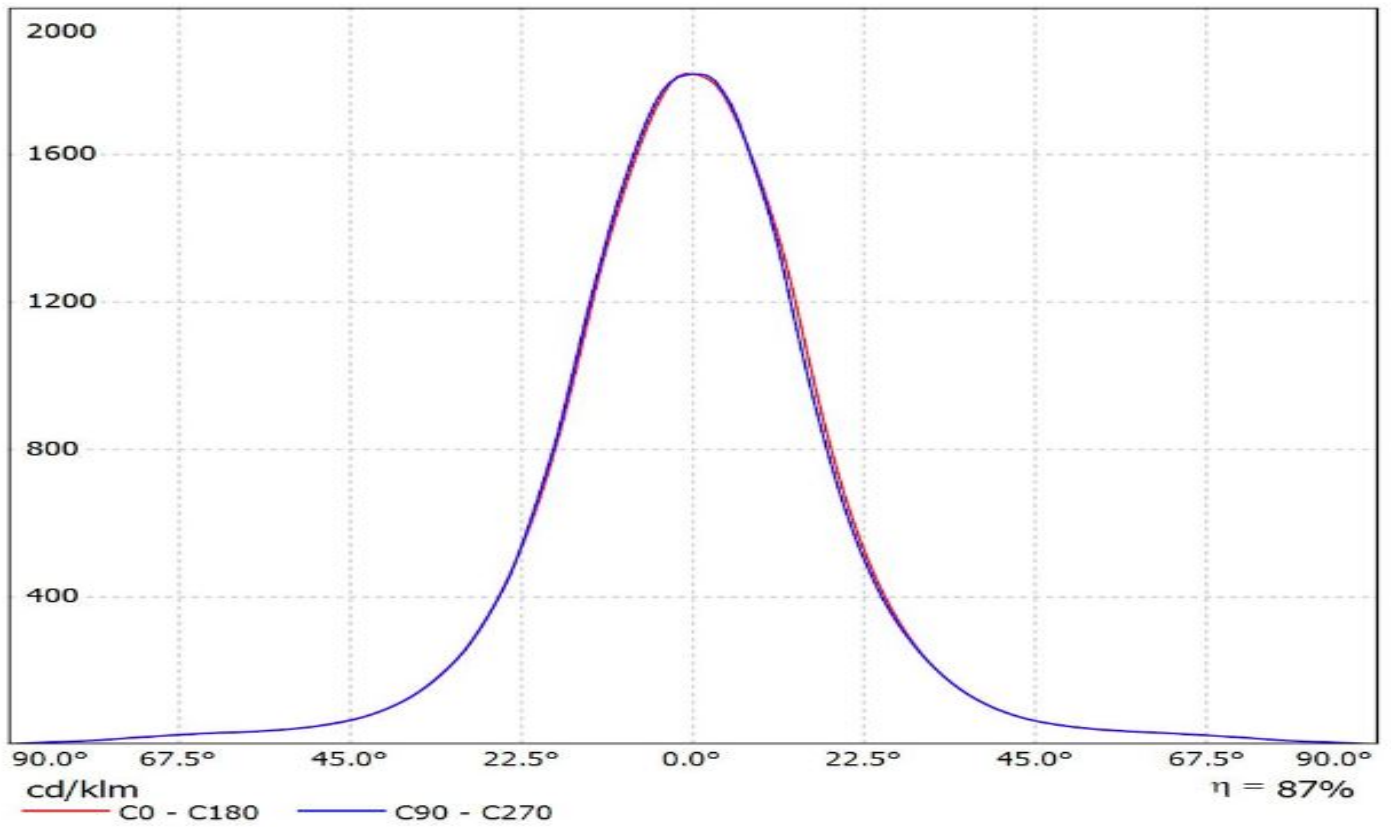

Luminaire: LEDiL Oy CN14237\_WINNIE-M\_(CLU024)\_434-Typ-L5

Lamps: 1 x Citizen\_CLU-024\_(CLU024-1204B8-303M1A2)\_434-Typ-L5\_1023.5lm@250mA\_P=8.57963W\_I=0.2498A

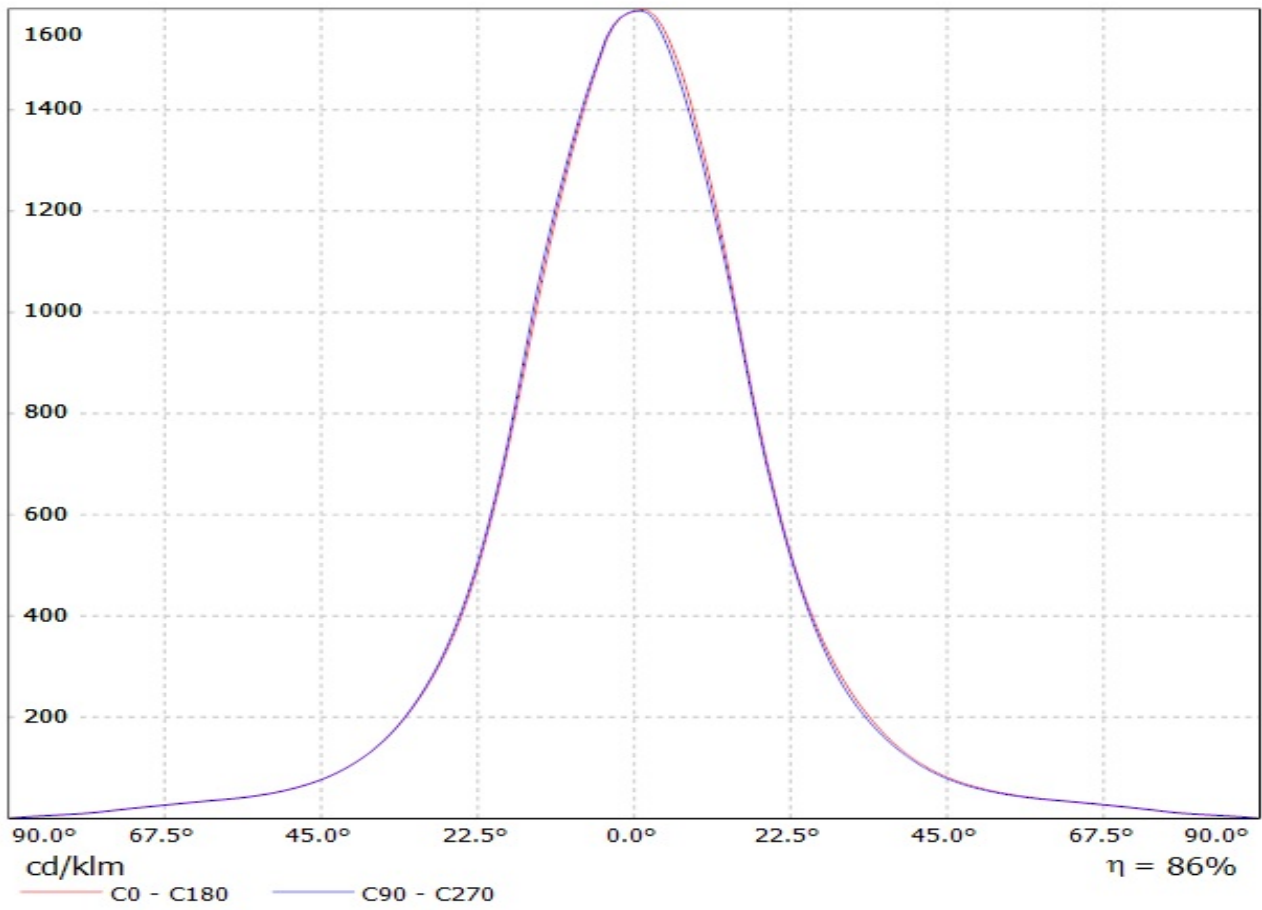

Luminaire: LEDiL Oy CN14237\_WINNIE-M (VERO10)

Lamps: 1 x Bridgelux\_VERO10\_(301000B)\_758.633lm@250mA\_P=6.35346W\_I=0.2499A

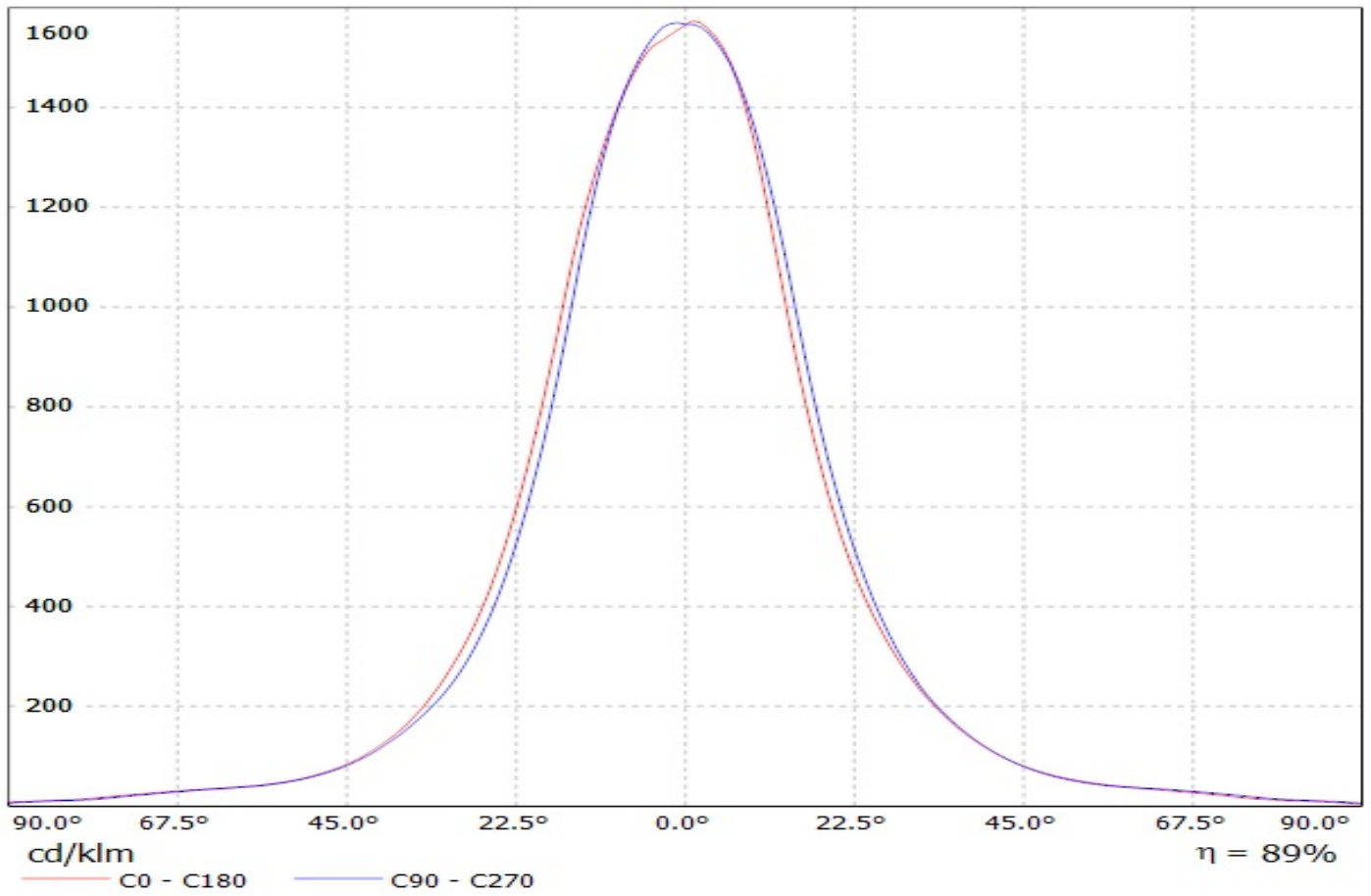

Luminaire: LEDiL Oy CN14237\_WINNIE-M\_(CITIZEN\_CLU720)

Lamps: 1 x CITIZEN\_CLU720\_(433 Typ L5)\_1198.27lm@250mA\_P=8.30318W\_I=0.25A

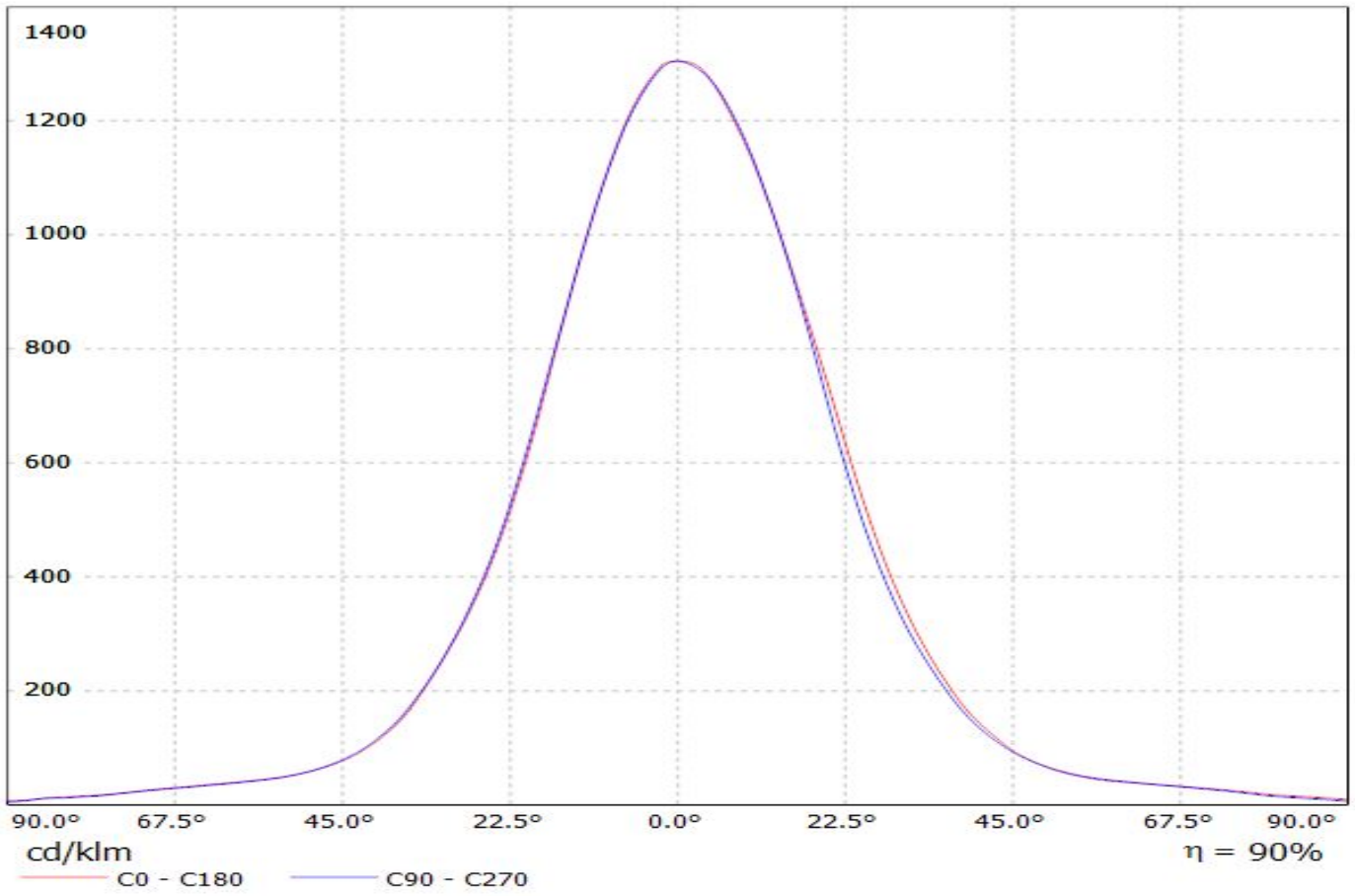

Luminaire: LEDiL Oy CN14237\_WINNIE-M\_(DMC125)

Lamps: 1 x DMC125+433\_Typ\_L5\_1101.77lm@250mA\_P=8.53017W\_I=250mA

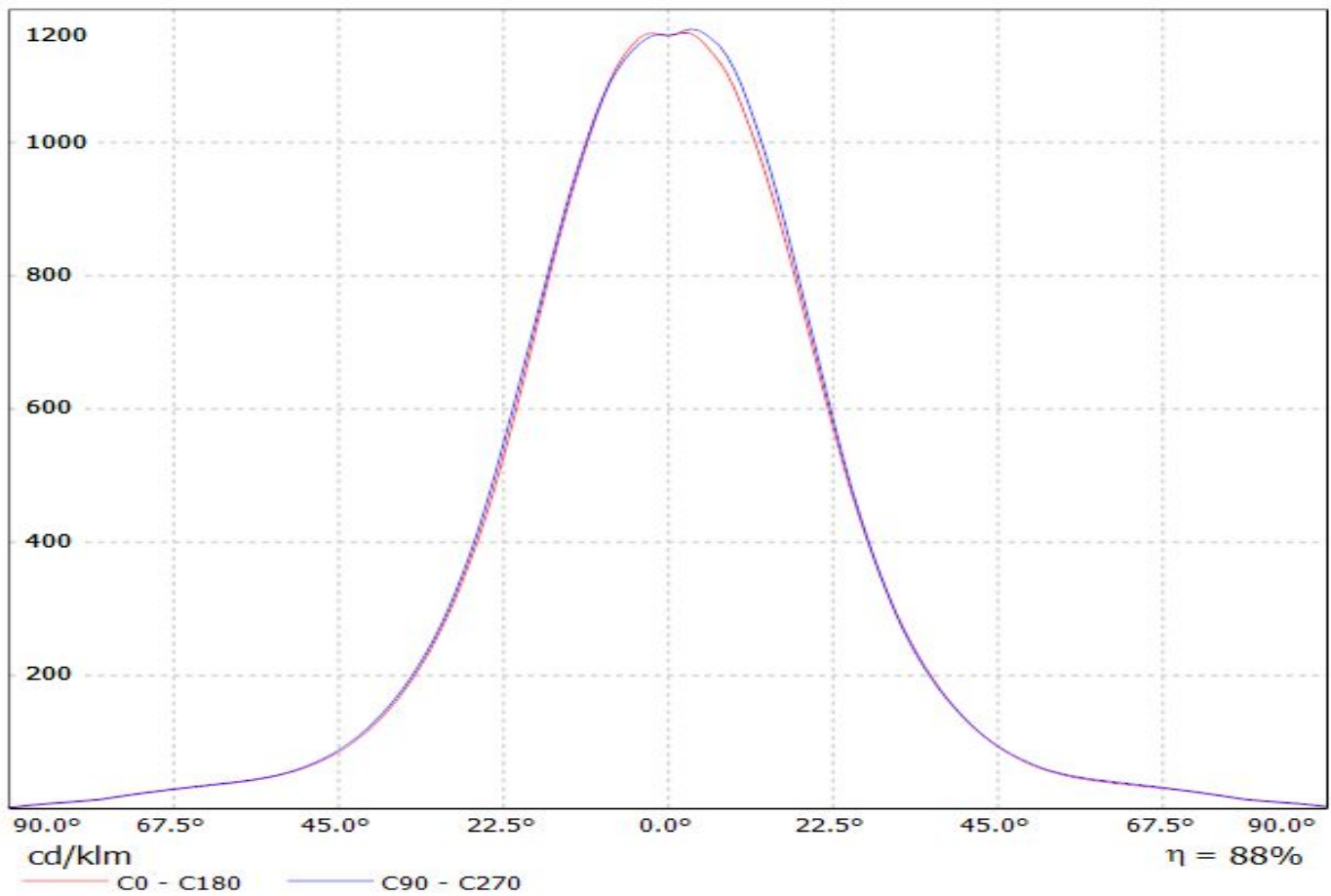

Luminaire: LEDiL Oy CN14237\_WINNIE-M\_(ZC12)

Lamps: 1 x Seoul\_ZC12\_(SDW82F1C)\_+\_B+W\_433\_Typ\_L5\_1217.21lm@250mA\_P=8.64733W\_I=250mA

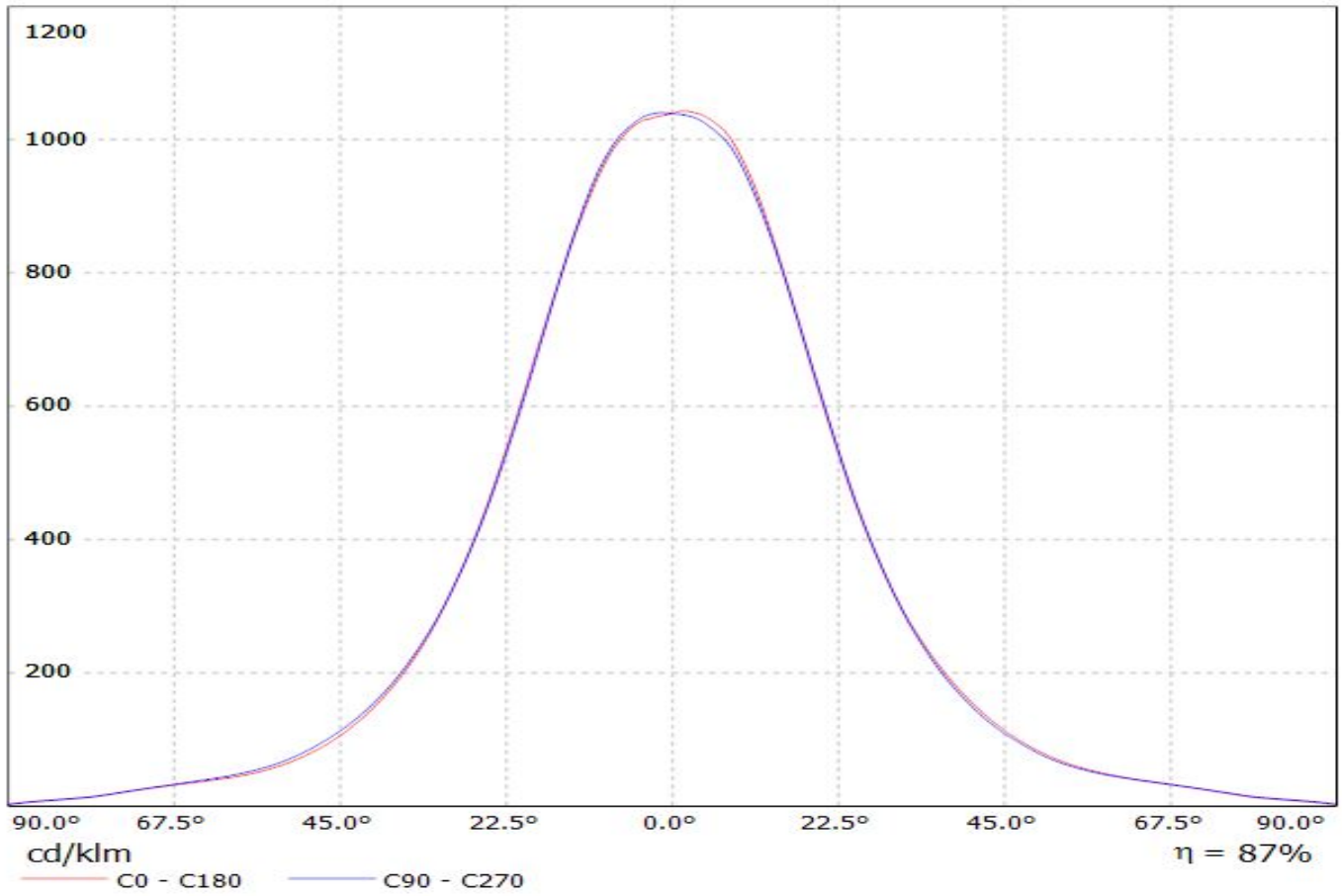

Luminaire: LEDiL Oy CN14237\_WINNIE-M\_(CLU034)

Lamps: 1 x Citizen\_CLU034\_(CLL034-1205B8-303M1A2)\_+\_B+W\_433\_Typ\_L5\_1154.06lm@250mA\_P=8.45523W\_I=250mA

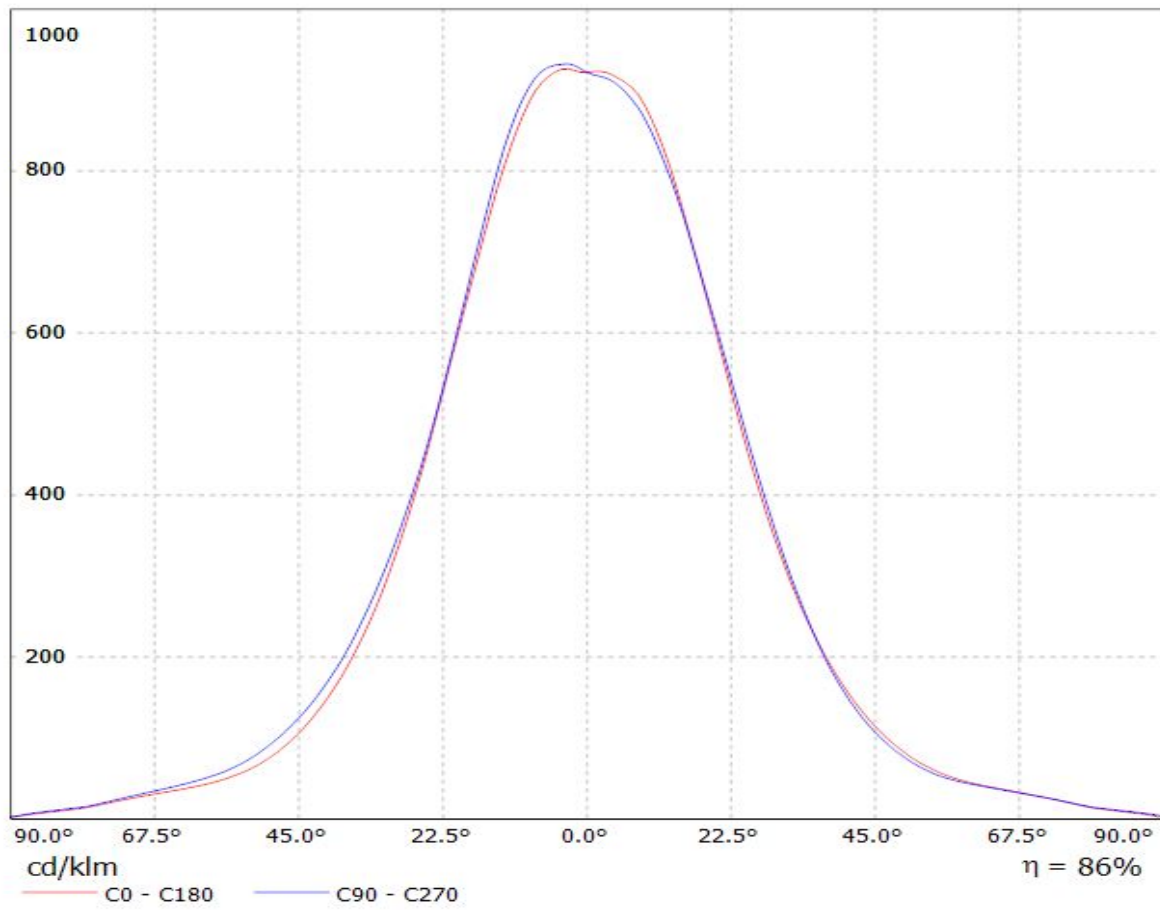

Luminaire: LEDiL Oy CN14237\_WINNIE-M\_(DMC128)

Lamps: 1 x DMC128+433\_TYP\_L5\_825.549lm@250mA\_P=8.28162W\_I=250mA

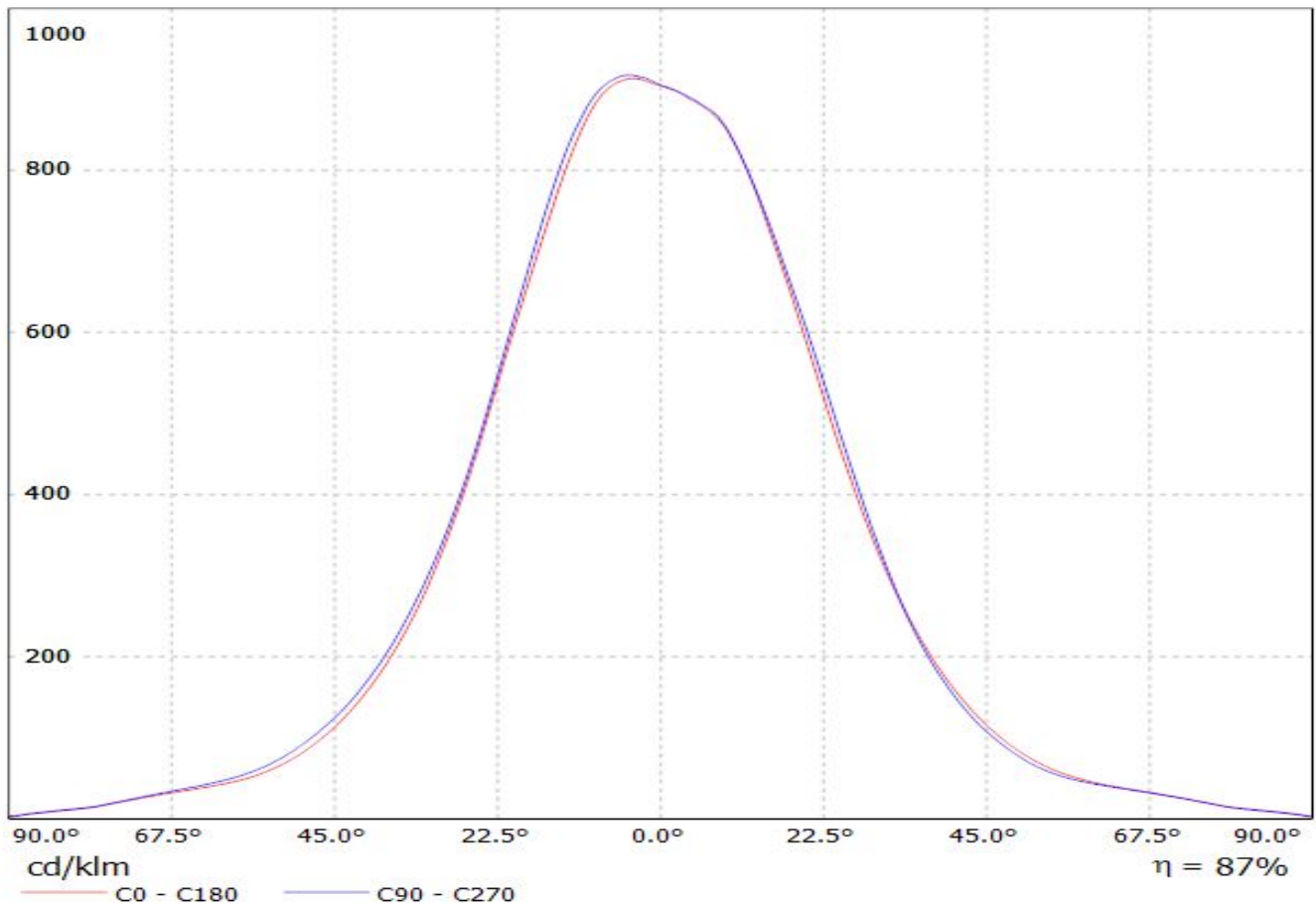

Luminaire: LEDiL Oy CN14237\_WINNIE-M\_(CLU700)

Lamps: 1 x Citizen\_CLU700\_367.467lm@100mA\_P=2.77574W\_I=0.1002A

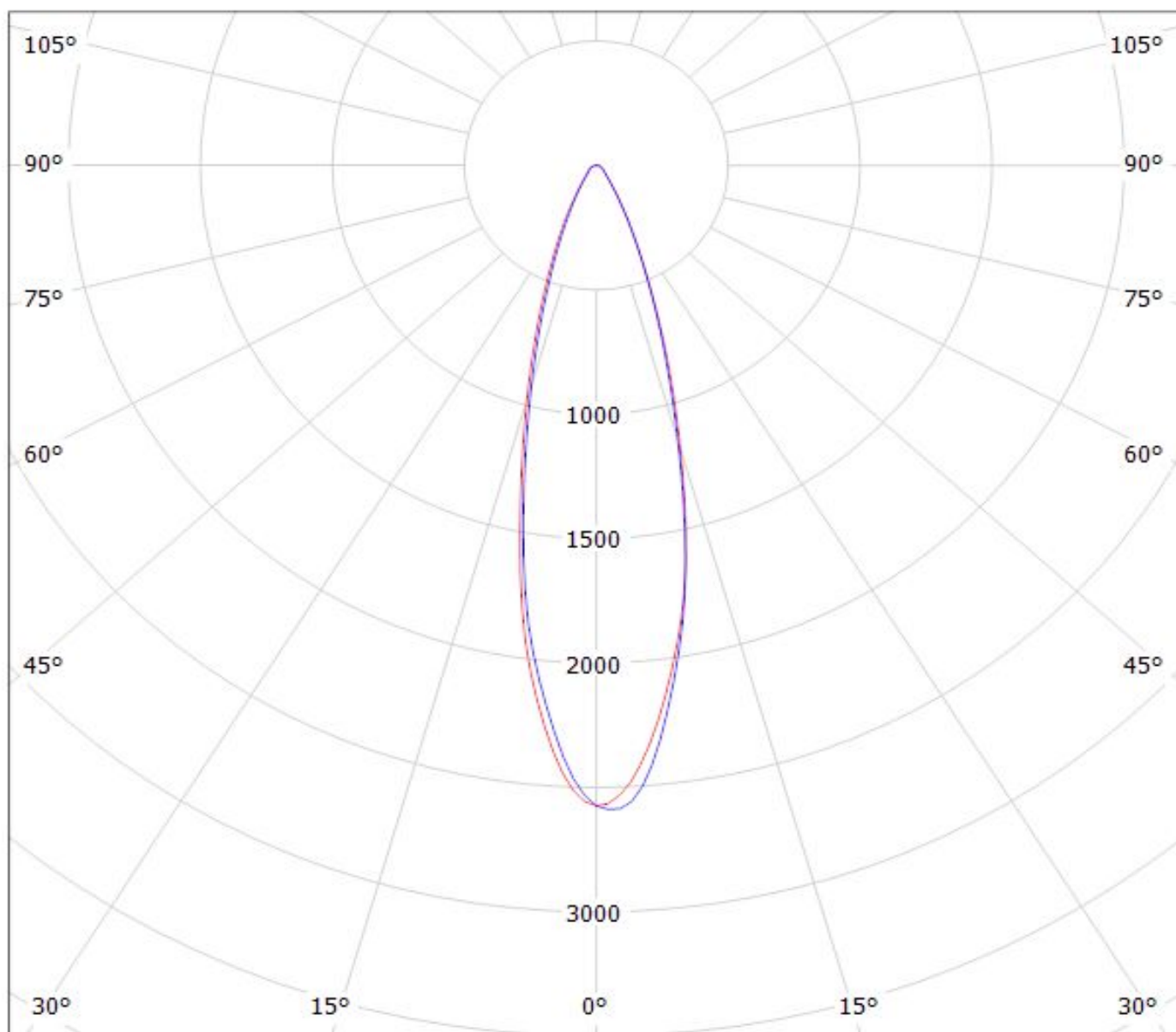

cd/klm

— C0 - C180

— C90 - C270

$\eta = 89\%$

Luminaire: LEDiL Oy CN14237\_WINNIE-M\_(CLU700)\_434-Typ-L5

Lamps: 1 x Citizen\_CLU700\_(CLU700-1002B8-273M2G1)\_434\_Typ\_L5\_377.008lm@100mA\_P=2.82212W\_I=0.1001A

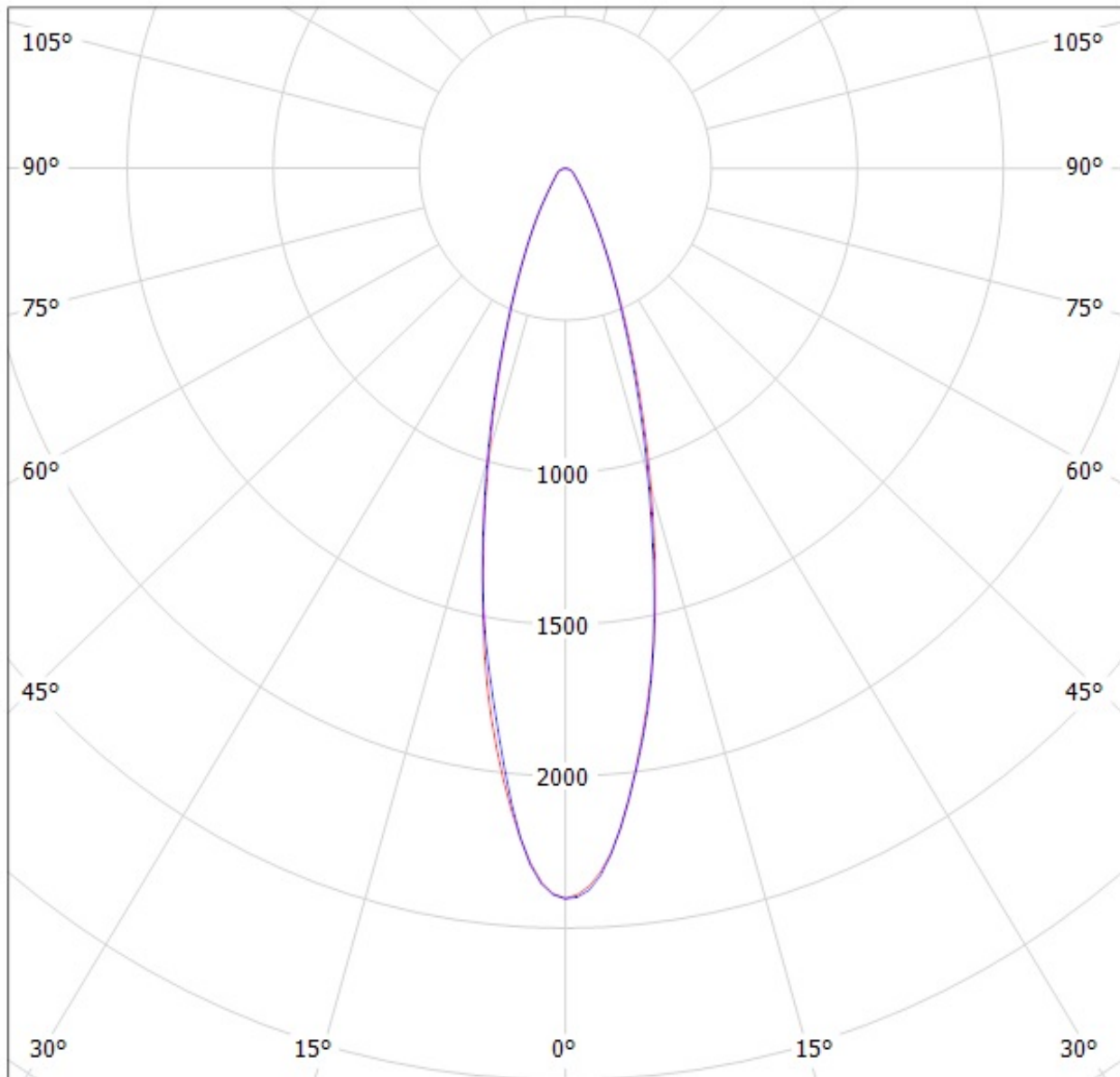

cd/klm

$\eta = 87\%$

— C0 - C180    — C90 - C270

Luminaire: Ledil CN14237\_WINNIE-M\_(MHD-G)

Lamps: 1 x Cree MHD-G\_530.44lm@100mA\_P=3.0W\_I=0.100A

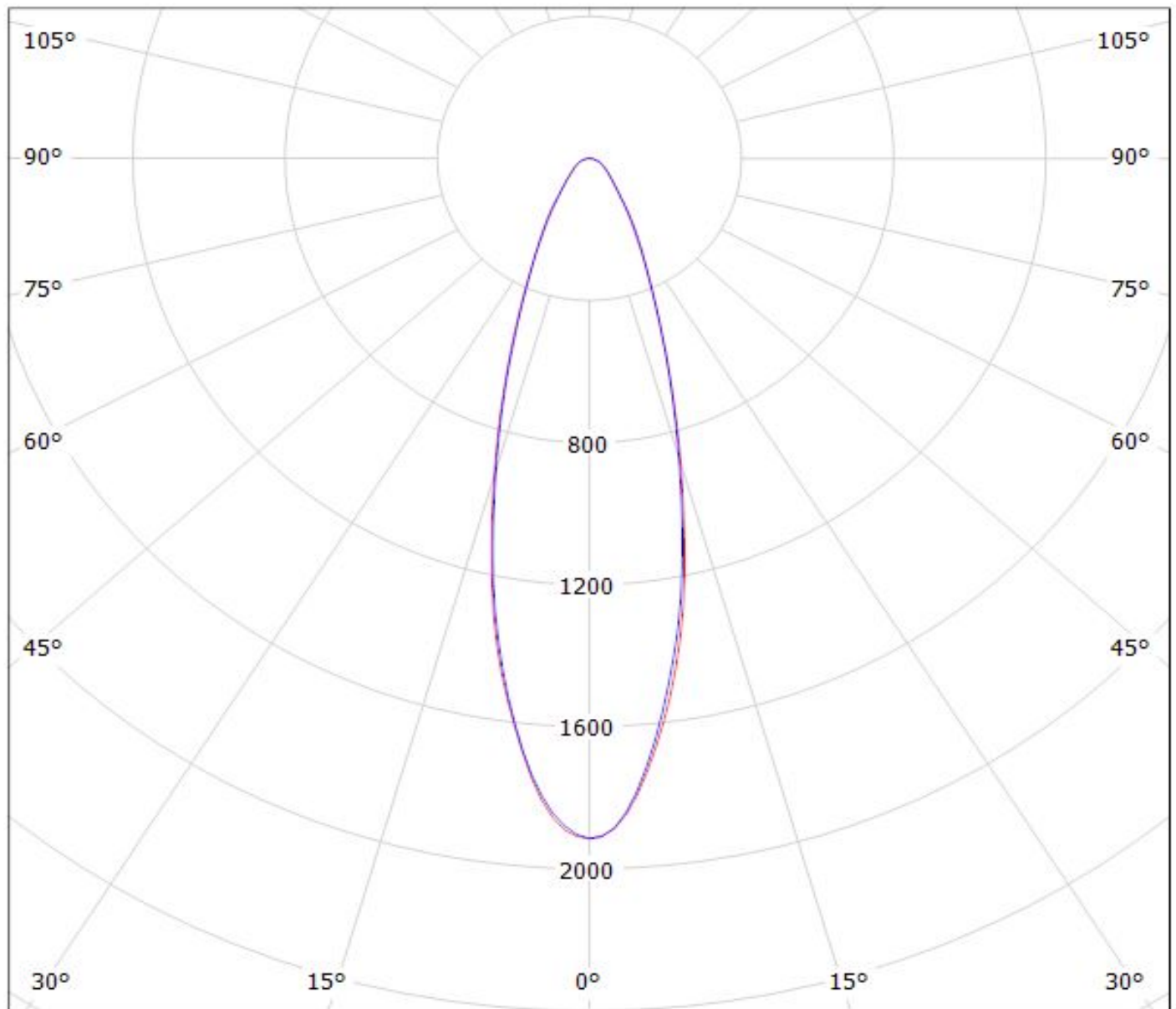

cd/klm

— C0 - C180 — C90 - C270

$\eta = 87\%$

# Ledil CN14237\_WINNIE-M\_(CLU710) / LDC (Polar)

Luminaire: Ledil CN14237\_WINNIE-M\_(CLU710)

Lamps: 1 x CITIZEN\_CLU710\_(CLU710-1204B8-273M2G1)\_1210.56lm@250mA\_P=8.5W\_I=0.25A

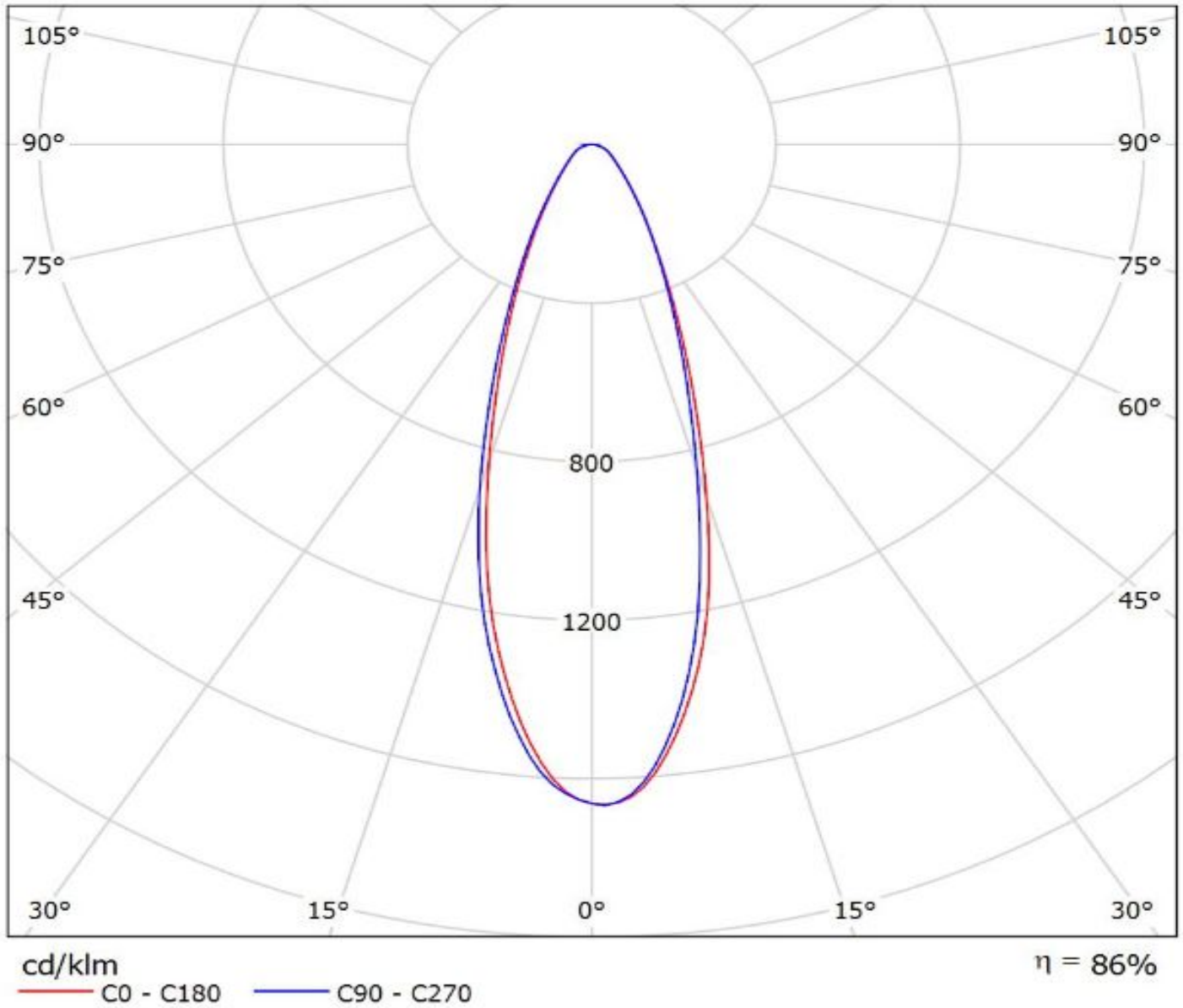

# Ledil CN14237\_WINNIE-M\_(CLU710)\_(470\_Typ\_L5) / LDC (Polar)

Luminaire: Ledil CN14237\_WINNIE-M\_(CLU710)\_(470\_Typ\_L5)  
Lamps: 1 x Citizen\_CLU710\_(CLU710-1204B8-273M2G1)\_(470\_Typ\_L5)  
\_1134.69lm@250mA\_CCT=2700K\_P=8.5W\_I=0.25A

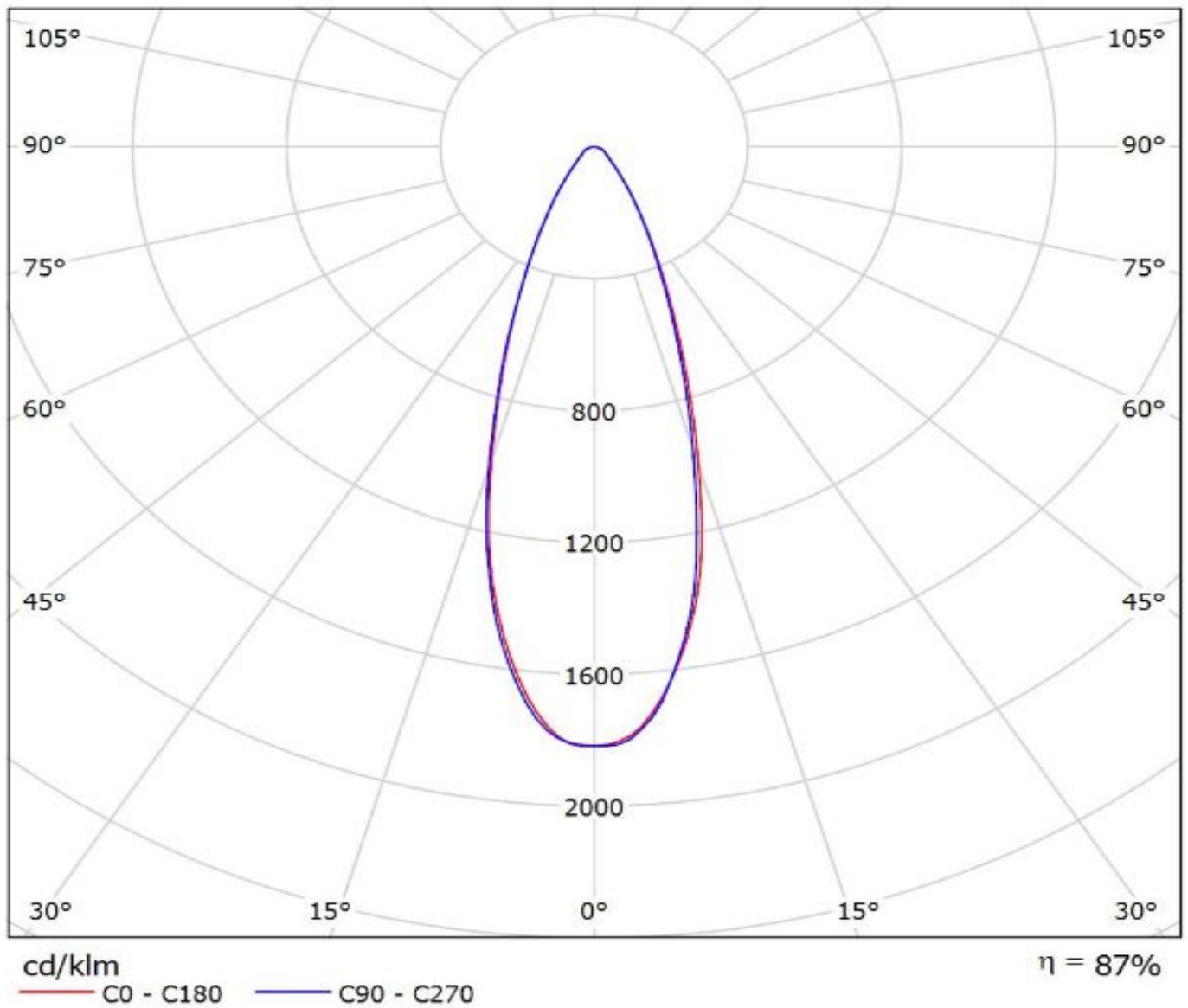

Luminaire: LEDiL Oy CN14237\_WINNIE-M\_(CLU024)\_434-Typ-L5

Lamps: 1 x Citizen\_CLU-024\_(CLU024-1204B8-303M1A2)\_434-Typ-L5\_1023.5lm@250mA\_P=8.57963W\_I=0.2498A

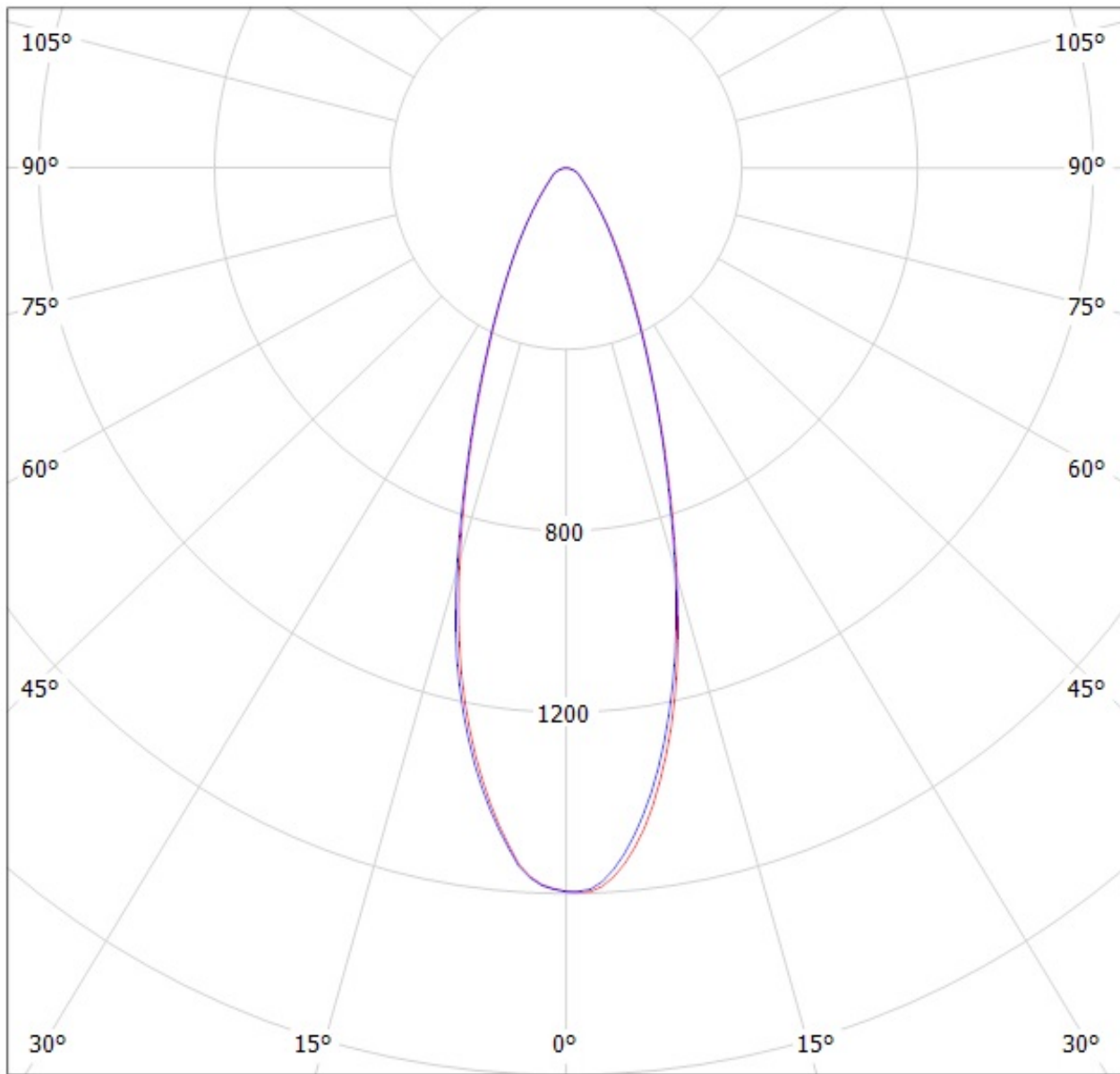

cd/klm

— C0 - C180

— C90 - C270

$\eta = 86\%$

Luminaire: LEDiL Oy CN14237\_WINNIE-M\_(VERO10)

Lamps: 1 x Bridgelux\_VERO10\_(301000B)\_758.633lm@250mA\_P=6.35346W\_I=0.2499A

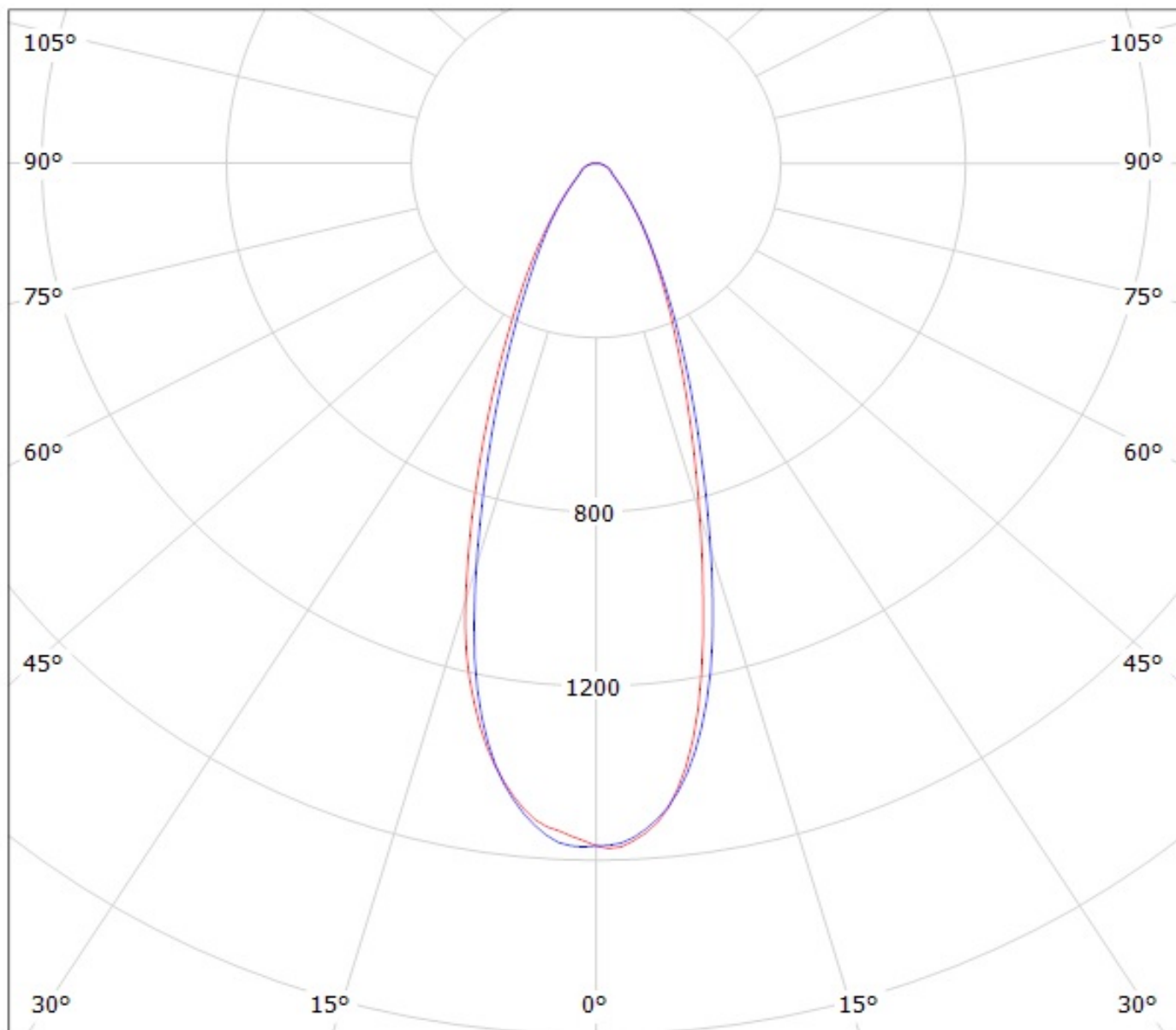

cd/klm

— C0 - C180

— C90 - C270

$\eta = 89\%$

Luminaire: LEDiL Oy CN14237\_WINNIE-M\_(CITIZEN\_CLU720)

Lamps: 1 x CITIZEN\_CLU720\_(433 Typ L5)\_1198.27lm@250mA\_P=8.30318W\_I=0.25A

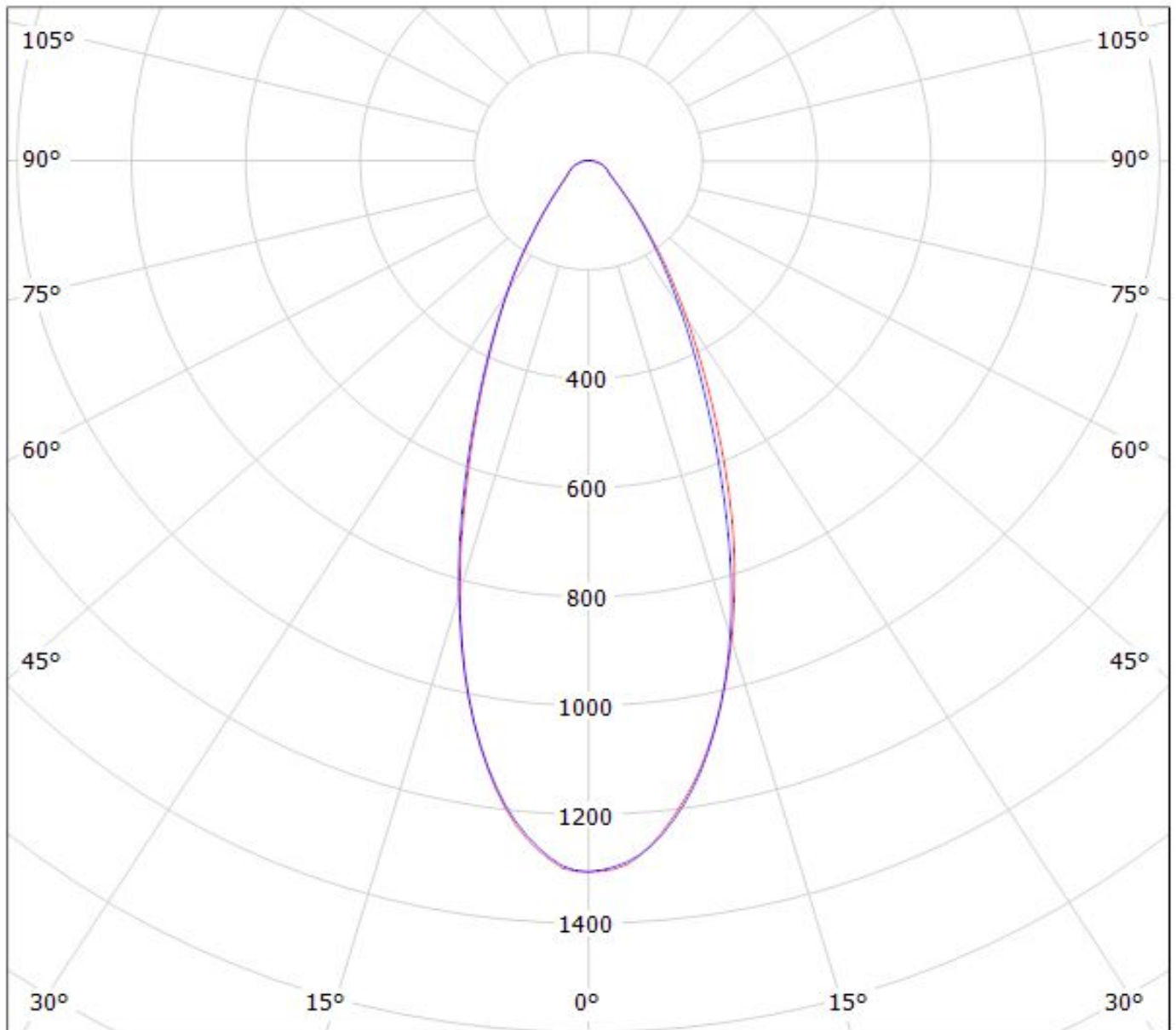

cd/klm

— C0 - C180

— C90 - C270

$\eta = 90\%$

Luminaire: LEDiL Oy CN14237\_WINNIE-M\_(DMC125)

Lamps: 1 x DMC125+433\_Typ\_L5\_1101.77lm@250mA\_P=8.53017W\_I=250mA

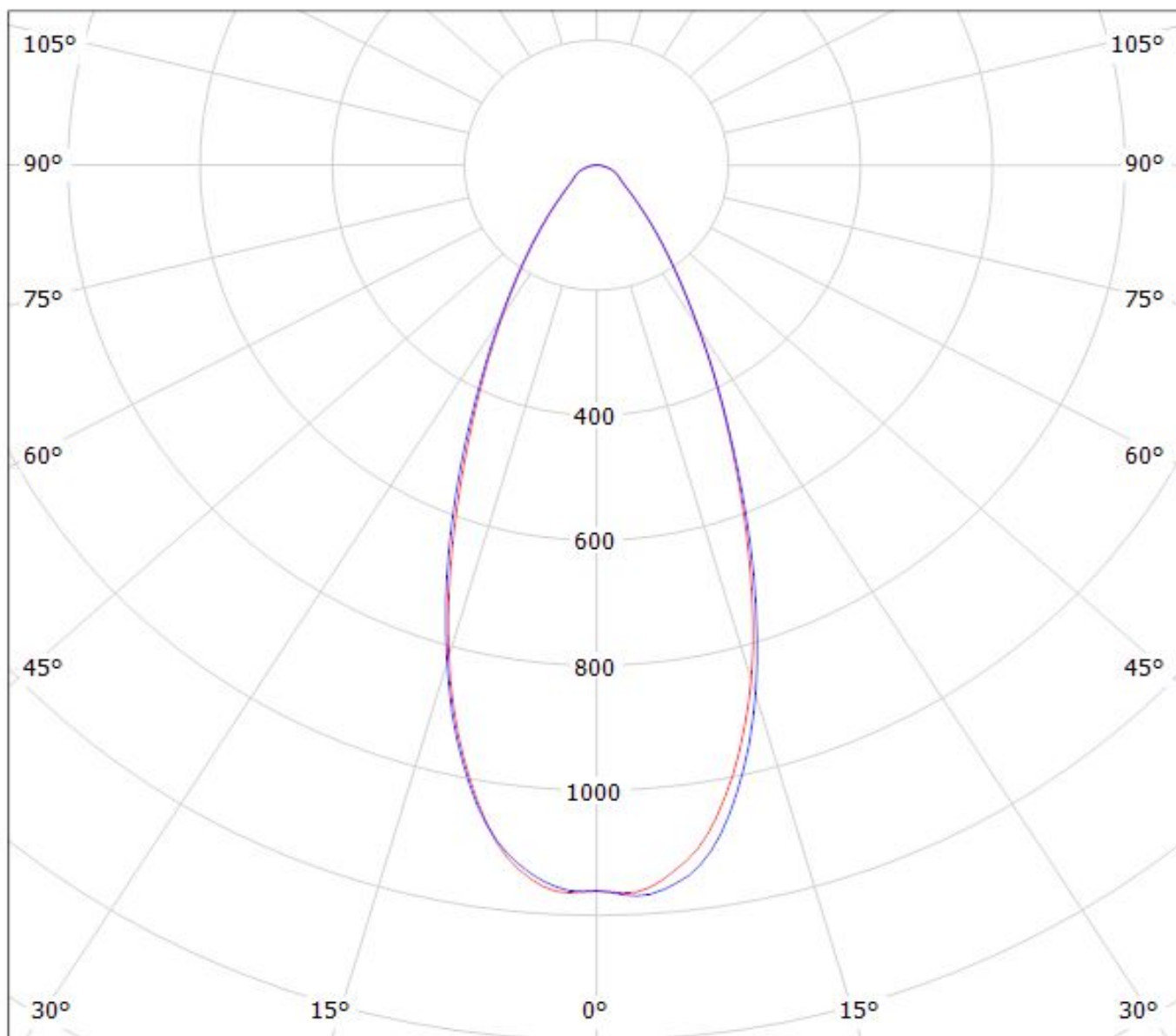

cd/klm

— C0 - C180

— C90 - C270

$\eta = 88\%$

Luminaire: LEDiL Oy CN14237\_WINNIE-M\_(ZC12)

Lamps: 1 x Seoul\_ZC12\_(SDW82F1C)\_+\_B+W\_433\_Typ\_L5\_1217.21lm@250mA\_P=8.64733W\_I=250mA

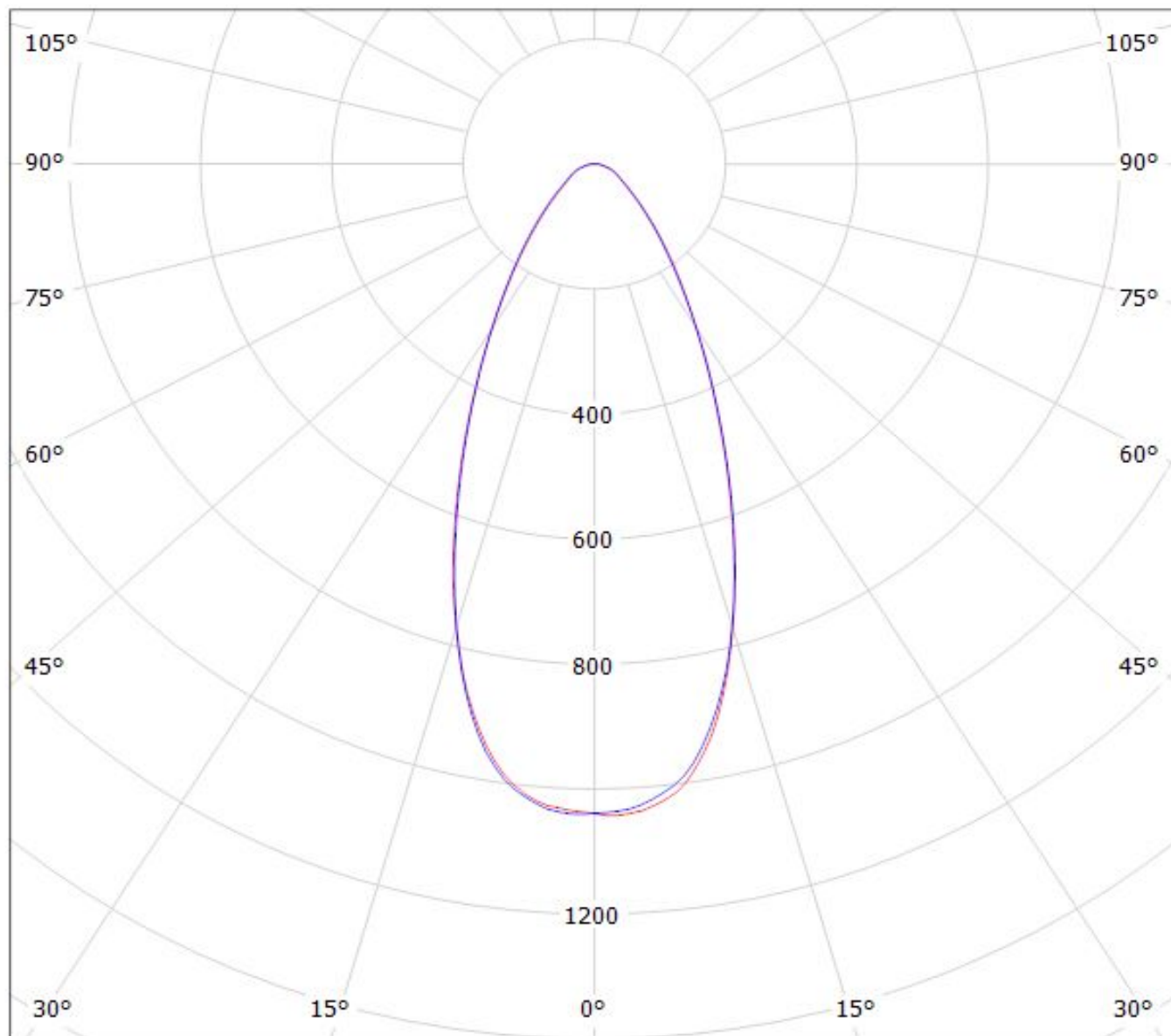

cd/klm

— C0 - C180

— C90 - C270

$\eta = 87\%$

Luminaire: LEDiL Oy CN14237\_WINNIE-M\_(CLU034)

Lamps: 1 x Citizen\_CLU034\_(CLL034-1205B8-303M1A2)\_+\_B+W\_433\_Typ\_L5\_1154.06lm@250mA\_P=8.45523W\_I=250mA

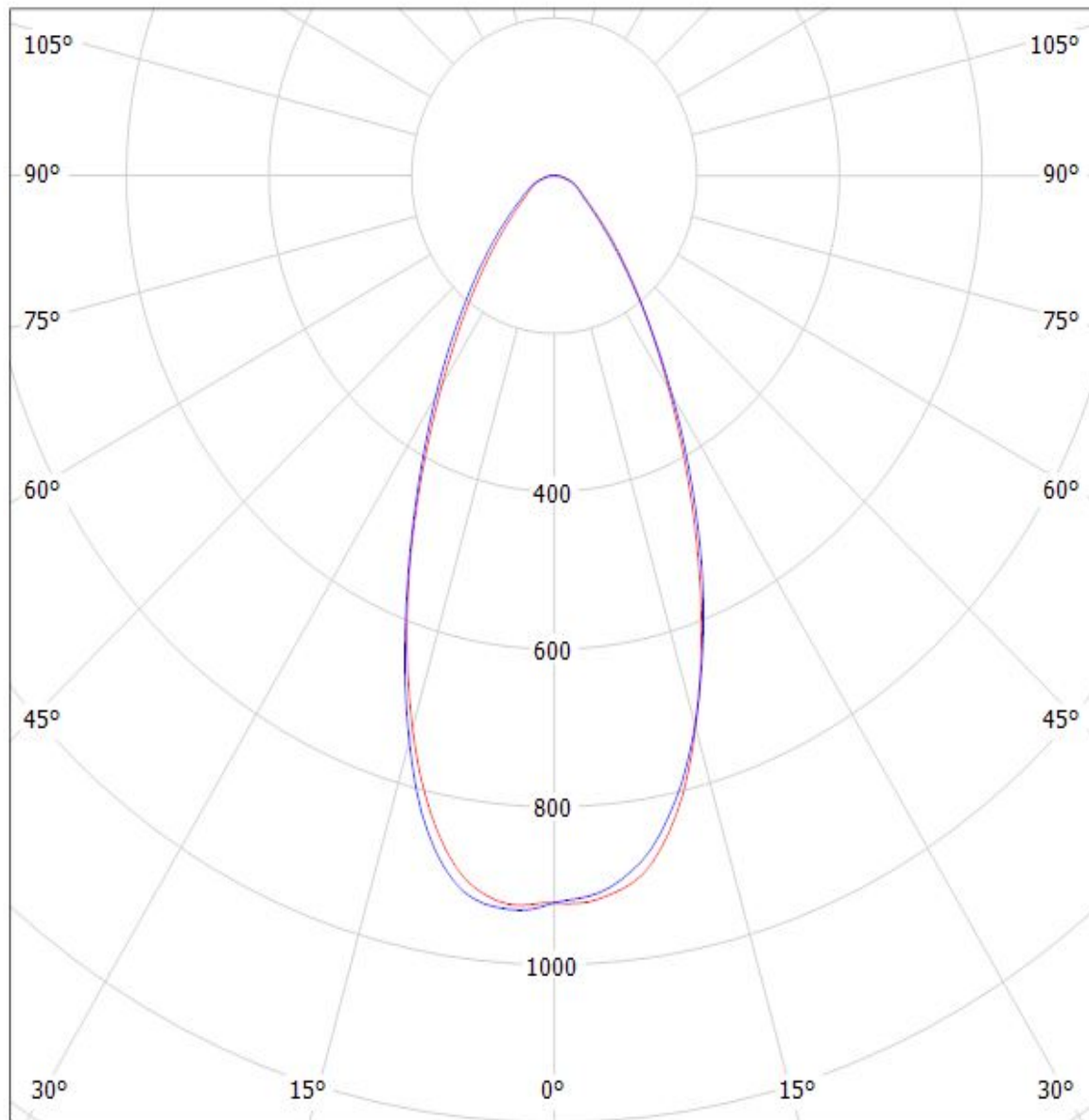

— C0 - C180 — C90 - C270

Luminaire: LEDiL Oy CN14237\_WINNIE-M\_(DMC128)

Lamps: 1 x DMC128+433\_TYP\_L5\_825.549lm@250mA\_P=8.28162W\_I=250mA

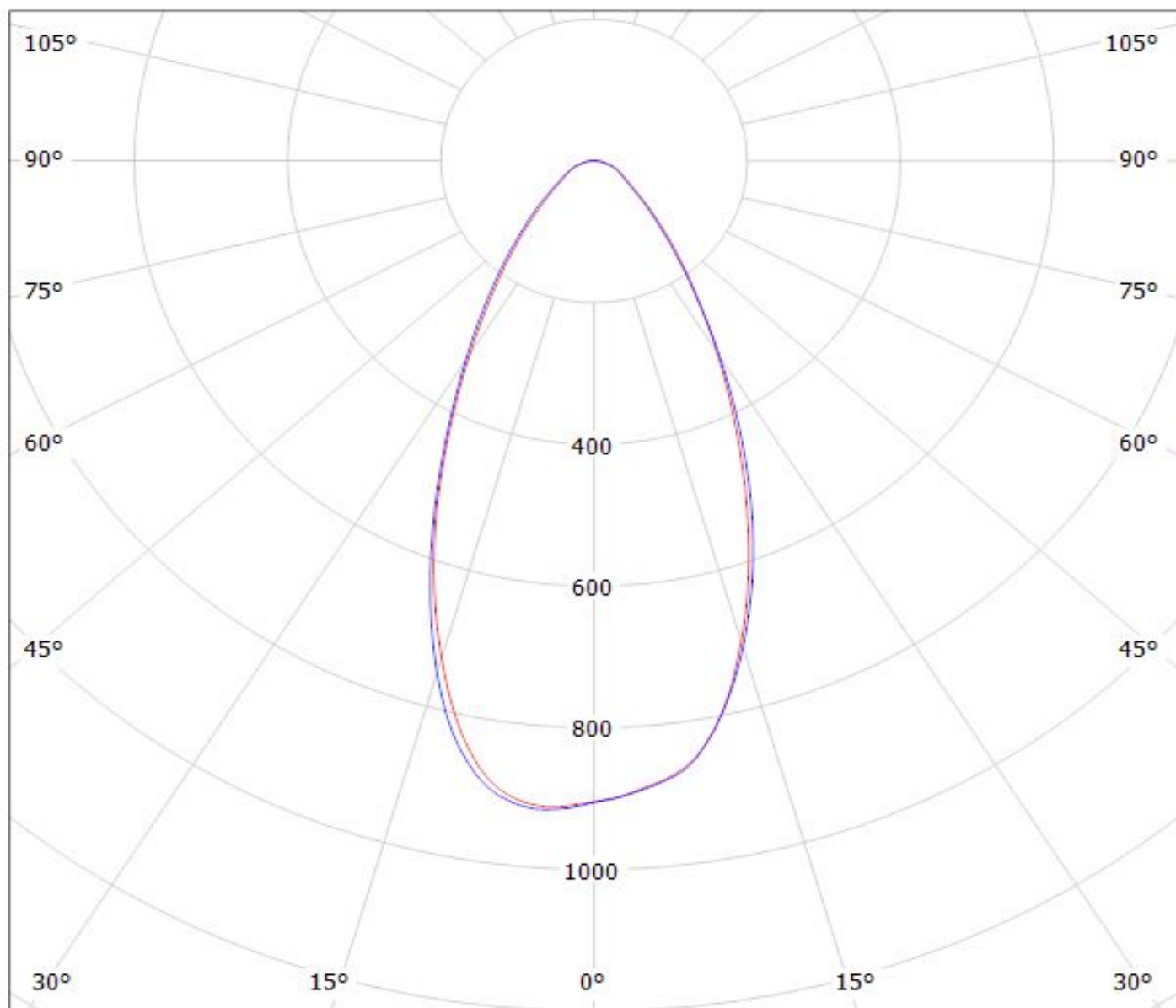

cd/klm

— C0 - C180

— C90 - C270

$\eta = 87\%$

**NOTE: The typical divergence will be changed by different color, chip size and chip position tolerance. The typical total divergence is the full angle measured where the luminous intensity is half of the peak value.**

### **GENERAL INFORMATION**

- Product series especially designed & optimized for series of LEDs.
- Special care taken to make light distribution as uniform as possible.

Note! Due to use of high power COB's with this product, special attention to proper thermal design is highly recommended. LEDiL has no liability for direct, indirect or consecutive damages arising from the LEDiL products being used outside of the recommended temperature range.