



TSV321-TSV358-TSV324

General Purpose, Input/Output Rail-to-Rail Low Power Operational Amplifiers

- Operating at $V_{CC} = 2.5V$ to $6V$
- Rail-to-rail input & output
- Extended V_{icm} ($V_{DD} - 0.2V$ to $V_{CC} + 0.2V$)
- Capable of driving a 32Ω load resistor
- High stability: $500pF$
- Available in SOT23-5 micropackage
- Operating temperature range: $-40, +125^{\circ}C$

Description

The TSV358 and TSV324 (dual & quad) are low voltage versions of LM358 and LM324 commodity operational amplifiers. TSV321 is the single version. The TSV321/358/324 are able to operate with voltage as low as $2.5V$ and features both I/O rail-to-rail.

The common mode input voltage extends $200mV$ at $25^{\circ}C$ beyond the supply voltages while the output voltage swing is within $100mV$ of each rail with 600Ω load resistor. These devices offer $1.3MHz$ of gain-bandwidth product and provide high output drive capability typically at $65mA$ -load.

These performances make the TSV3xx family ideal for active filters, general purpose low-voltage applications, general purpose portable devices.

Applications

- Battery-powered applications
- Audio driver (headphone driver)
- Sensor signal conditioning
- Laptop/notebook computers

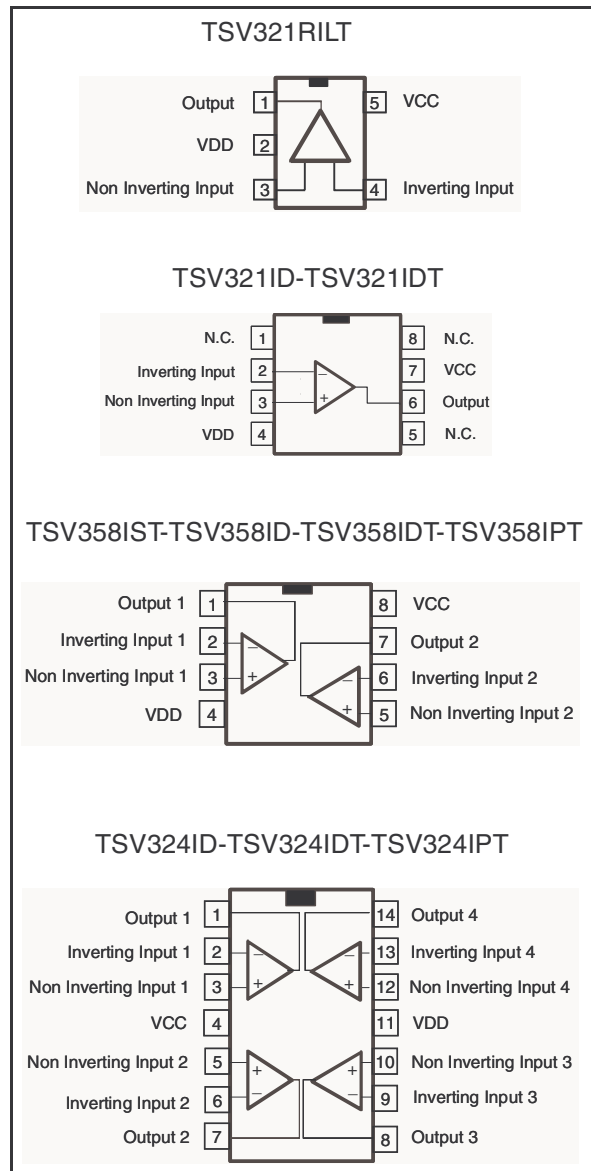

1 Order Codes

Part Number	Temperature Range	Package	Packaging	Marking
TSV321RILT	-40°C to +125°C	SOT23-5L	Tape & Reel	K174
TSV321RAILT		SOT23-5L	Tape & Reel	K178
TSV321ID/IDT		SO-8	Tube or Tape & Reel	V321ID
TSV358ID/IDT				V358ID
TSV358IPT		TSSOP8 (Thin Shrink Outline Package)	Tape & Reel	V358I
TSV358IST		MiniSO-8		K175
TSV358IYD/IYDT		SO-8 (automotive grade level)	Tube or Tape & Reel	
TSV358IYPT		TSSOP8 (automotive grade level)	Tape & Reel	V358Y
TSV324ID/IDT		SO-14	Tube or Tape & Reel	V324ID
TSV324IPT		TSSOP14 (Thin Shrink Outline Package)	Tape & Reel	V324IP

2 Absolute Maximum Ratings

Table 1. Key parameters and their absolute maximum ratings

Symbol	Parameter	Value	Unit
V_{CC}	Supply Voltage ⁽¹⁾	7	V
V_{id}	Differential Input Voltage ⁽²⁾	± 1	V
V_i	Input Voltage	$V_{DD}-0.3$ to $V_{CC}+0.3$	V
T_{stg}	Storage Temperature	-65 to +150	°C
T_j	Maximum Junction Temperature	150	°C
R_{thja}	Thermal Resistance Junction to Ambient ⁽³⁾		°C/W
	SOT23-5	250	
	SO-8	125	
	SO-14	103	
	TSSOP8	120	
	TSSOP14 MiniSO-8	100 190	
ESD	HBM: Human Body Model ⁽⁴⁾	2	kV
	MM: Machine Model ⁽⁵⁾	200	V
	CDM: Charged Device Model	1.5	kV
	Latch-up Immunity	200	mA
	Lead Temperature (soldering, 10s)	250	°C
	Output Short Circuit Duration	see note ⁽⁶⁾	

- All voltages values, except differential voltage are with respect to network terminal.
- Differential voltages are the non-inverting input terminal with respect to the inverting input terminal. If $V_{id} > \pm 1V$, the maximum input current must not exceed $\pm 1mA$. In this case ($V_{id} > \pm 1V$) an input series resistor must be added to limit input current.
- Short-circuits can cause excessive heating. Destructive dissipation can result from simultaneous short-circuit on all amplifiers.
- Human body model, 100pF discharged through a 1.5k Ω resistor into pin of device.
- Machine model ESD, a 200pF cap is charged to the specified voltage, then discharged directly into the IC with no external series resistor (internal resistor < 5 Ω), into pin to pin of device.
- Short-circuits from the output to V_{CC} can cause excessive heating. The maximum output current is approximately 80mA, independent of the magnitude of V_{CC} . Destructive dissipation can result from simultaneous short-circuits on all amplifiers.

Table 2. Operating conditions

Symbol	Parameter	Value	Unit
V_{CC}	Supply Voltage	2.5 to 6	V
V_{icm}	Common Mode Input Voltage Range ⁽¹⁾	$V_{DD} - 0.2$ to $V_{CC} + 0.2$	V
V_{icm}	Common Mode Input Voltage Range ⁽²⁾	V_{DD} to V_{CC}	V
T_{oper}	Operating Free Air Temperature Range	-40 to + 125	°C

- At 25°C, for $2.5 \leq V_{CC} \leq 6V$, V_{icm} is extended to $V_{DD} - 0.2V$, $V_{CC} + 0.2V$.
- In full temperature range, both Rails can be reached when V_{CC} does not exceed 5.5V.

3 Electrical Characteristics

Table 3. $V_{CC} = +3V$, $V_{DD} = 0V$, R_L , C_L connected to $V_{CC}/2$, $T_{amb} = 25^\circ C$ (unless otherwise specified)

Symbol	Parameter	Conditions	Min.	Typ.	Max.	Unit
V_{io}	Input Offset Voltage	$V_{icm} = V_{out} = V_{CC}/2$ TSV321/358/324 TSV321A/358A/324A		0.2 0.1	3 1	mV
ΔV_{io}	Input Offset Voltage Drift			2		$\mu V/^\circ C$
I_{io}	Input Offset Current ⁽¹⁾	$V_{icm} = V_{out} = V_{CC}/2$		3	30	nA
I_{ib}	Input Bias Current ⁽¹⁾	$V_{icm} = V_{out} = V_{CC}/2$		4	125	nA
CMR	Common Mode Rejection Ratio	$0 \leq V_{icm} \leq V_{CC}$, $V_{out} = V_{CC}/2$	60	80		dB
SVR	Supply Voltage Rejection Ratio		70	85		dB
A_{vd}	Large Signal Voltage Gain	$V_{out} = 0.5V$ to $2.5V$ $R_L = 2k\Omega$ $R_L = 600\Omega$	80 74	92 95		dB
V_{OH}	High Level Output Voltage	$V_{id} = 100mV$ $R_L = 2k\Omega$ $R_L = 600\Omega$	2.82 2.80	2.95 2.95		V
V_{OL}	Low Level Output Voltage	$V_{id} = -100mV$ $R_L = 2k\Omega$ $R_L = 600\Omega$		88 115	120 160	mV
I_o	Output Source Current	$V_{ID} = 100mV$, $V_O = V_{DD}$	20	80		mA
	Output Sink Current	$V_{ID} = -100mV$, $V_O = V_{CC}$	20	80		
I_{CC}	Supply Current (per amplifier)	$A_{VCL} = 1$, no load		420	650	μA
GBP	Gain Bandwidth Product	$R_L = 10k\Omega$, $C_L = 100pF$, $f = 100kHz$	1	1.3		MHz
SR	Slew Rate	$R_L = 10k\Omega$, $C_L = 100pF$, $AV = 1$	0.42	0.6		$V/\mu s$
ϕ_m	Phase Margin	$C_L = 100pF$		53		Degrees
e_n	Input Voltage Noise			27		nV/\sqrt{Hz}
THD	Total Harmonic Distortion			0.01		%

1. Maximum values including unavoidable inaccuracies of the industrial test.

Table 4. $V_{CC} = +5V$, $V_{DD} = 0V$, R_L , C_L connected to $V_{CC}/2$, $T_{amb} = 25^\circ C$ (unless otherwise specified)

Symbol	Parameter	Conditions	Min.	Typ.	Max.	Unit
V_{io}	Input Offset Voltage	$V_{icm} = V_{out} = V_{CC}/2$ TSV321/358/324 TSV321A/358A/324A		0.2 0.1	3 1	mV
ΔV_{io}	Input Offset Voltage Drift			2		$\mu V/^\circ C$
I_{io}	Input Offset Current ⁽¹⁾	$V_{icm} = V_{out} = V_{CC}/2$		3	30	nA
I_{ib}	Input Bias Current ⁽¹⁾	$V_{icm} = V_{out} = V_{CC}/2$		70	130	nA
CMR	Common Mode Rejection Ratio	$0 \leq V_{icm} \leq V_{CC}$, $V_{out} = V_{CC}/2$	65	85		dB
SVR	Supply Voltage Rejection Ratio		70	90		dB
A_{vd}	Large Signal Voltage Gain	$V_{out} = 0.5V$ to $2.5V$ $R_L = 2k\Omega$ $R_L = 600\Omega$	83 77	92 85		dB
V_{OH}	High Level Output Voltage	$V_{id} = 100mV$ $R_L = 2k\Omega$ $R_L = 600\Omega$	4.80 4.75	4.95 4.90		V
V_{OL}	Low Level Output Voltage	$V_{id} = -100mV$ $R_L = 2k\Omega$ $R_L = 600\Omega$		88 115	130 188	mV
I_o	Output Source Current	$V_{ID} = 100mV$, $V_O = V_{DD}$	20	80		mA
	Output Sink Current	$V_{ID} = -100mV$, $V_O = V_{CC}$	20	80		
I_{CC}	Supply Current (per amplifier)	$A_{VCL} = 1$, no load		500	835	μA
GBP	Gain Bandwidth Product	$R_L = 10k\Omega$, $C_L = 100pF$, $f = 100kHz$	1	1.4		MHz
SR	Slew Rate	$R_L = 10k\Omega$, $C_L = 100pF$, $AV = 1$	0.42	0.6		$V/\mu s$
ϕ_m	Phase Margin	$C_L = 100pF$		55		Degrees
e_n	Input Voltage Noise			27		nV/\sqrt{Hz}
THD	Total Harmonic Distortion			0.01		%

1. Maximum values including unavoidable inaccuracies of the industrial test.

Figure 1. Supply current/amplifier vs. supply voltage

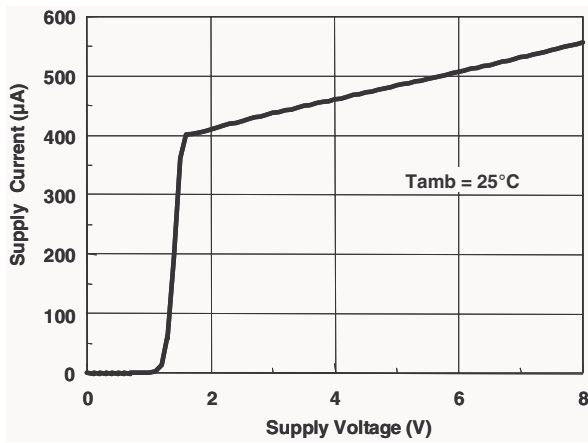

Figure 2. Supply current/amplifier vs. temperature

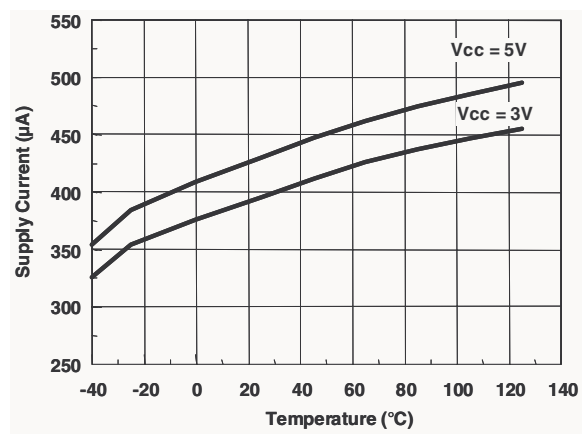

Figure 3. Output power vs. supply voltage

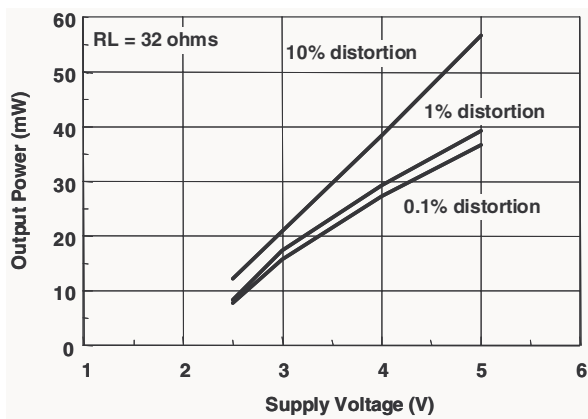

Figure 4. Input offset voltage drift vs. temperature

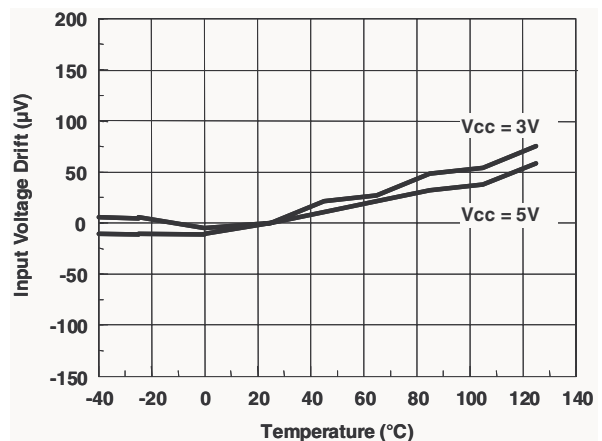

Figure 5. Input bias current vs. temperature

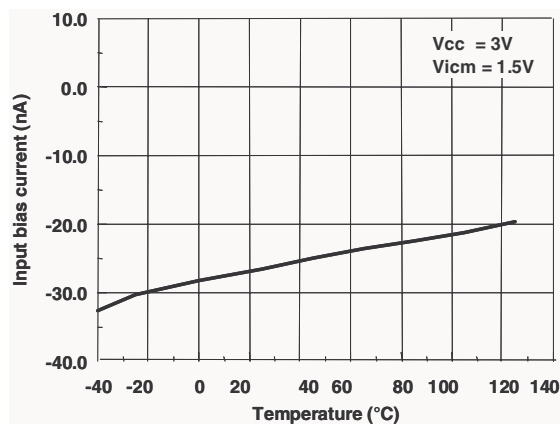

Figure 6. Open loop gain vs. temperature

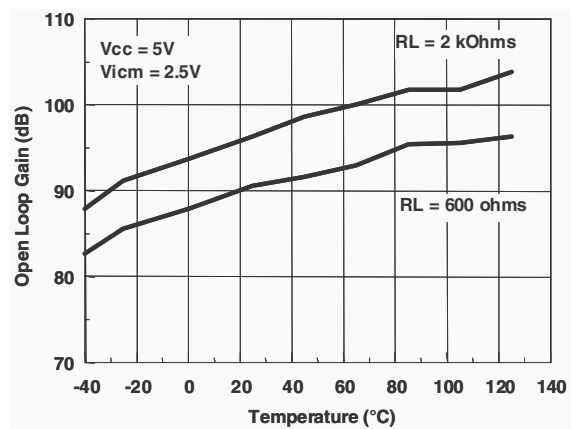

Figure 7. Open loop gain vs. temperature

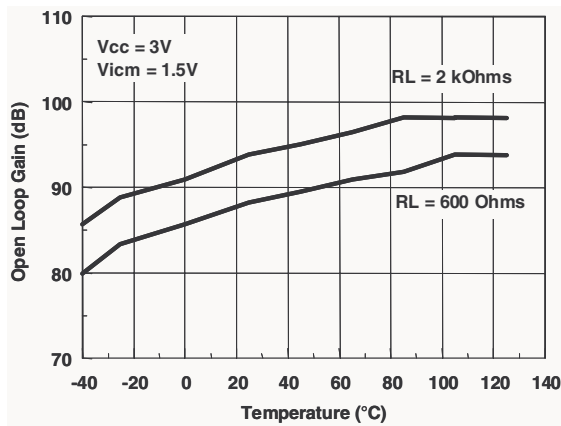

Figure 8. High level output voltage vs. temperature

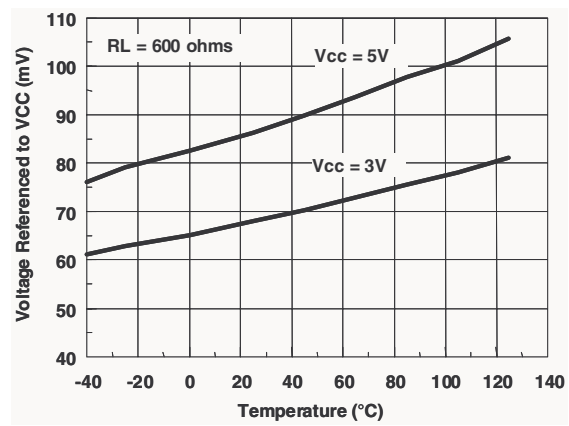

Figure 9. Low level output voltage vs. temperature

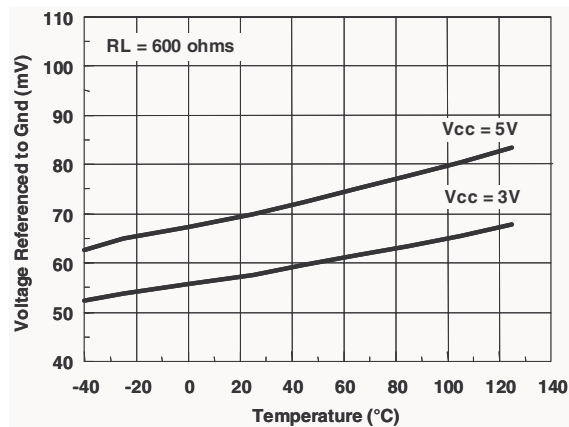

Figure 10. Output current vs. temperature

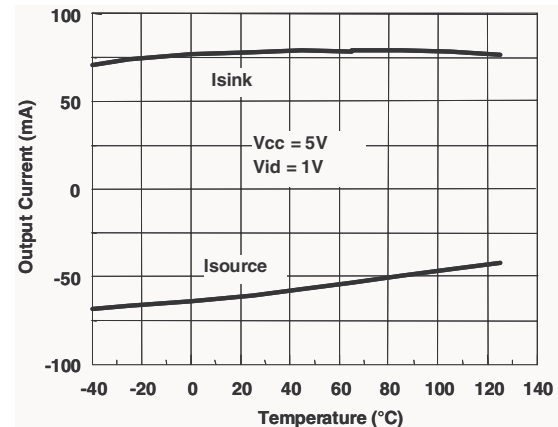

Figure 11. Output current vs. temperature

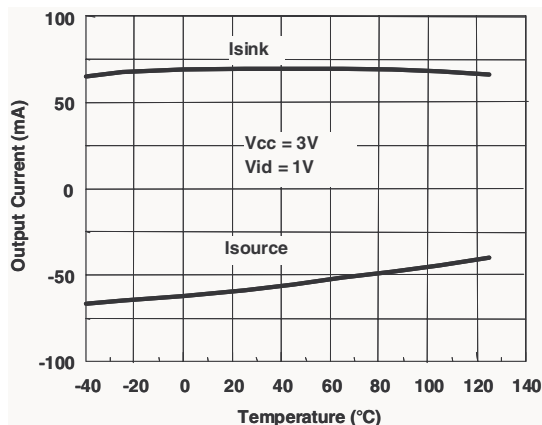

Figure 12. Output current vs. temperature

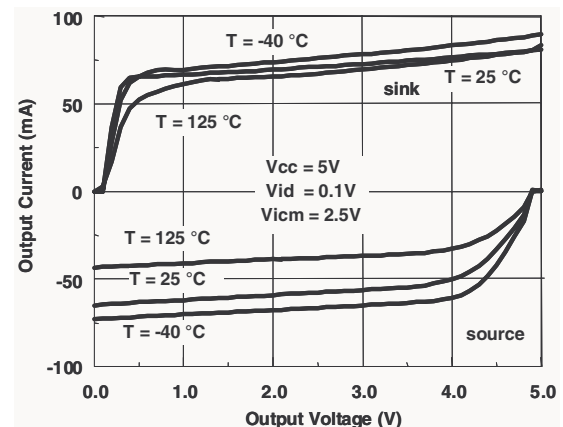

Figure 13. Output current vs. temperature

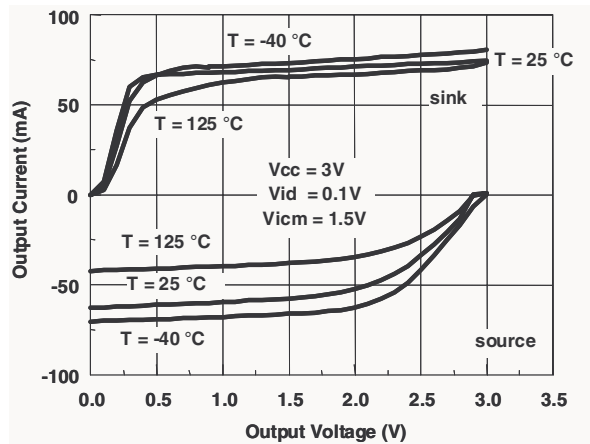

Figure 14. Gain & phase vs. frequency

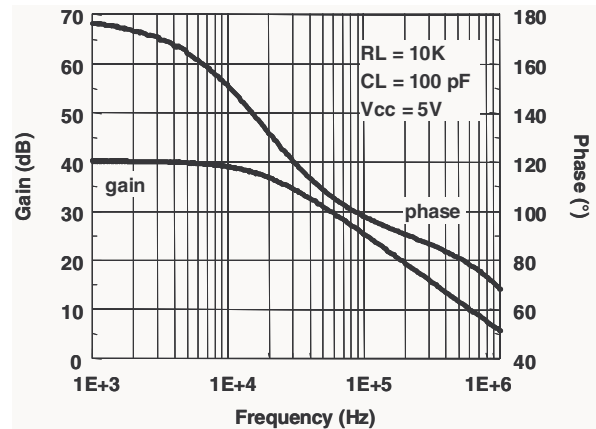

Figure 15. Gain & phase vs. frequency

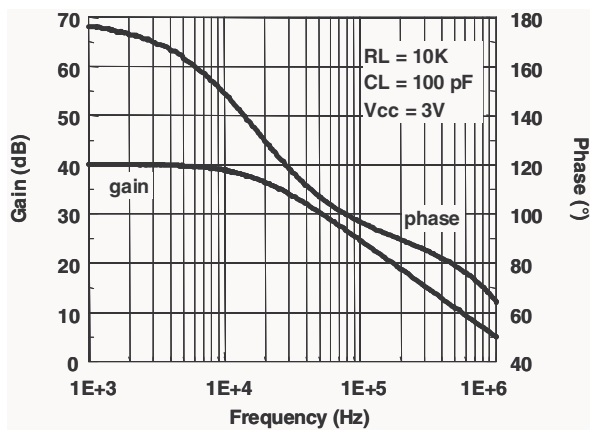

Figure 16. Slew rate vs. temperature

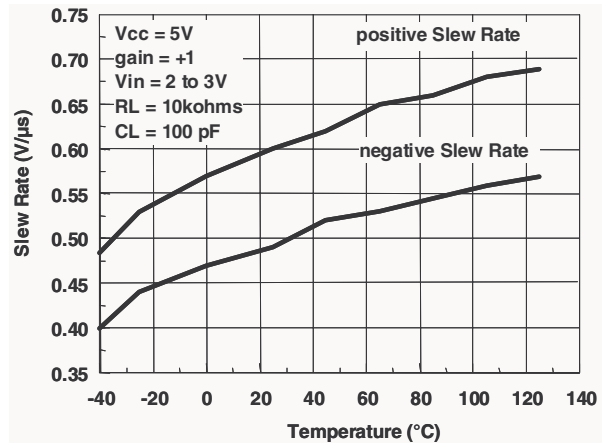

Figure 17. Slew rate vs. temperature

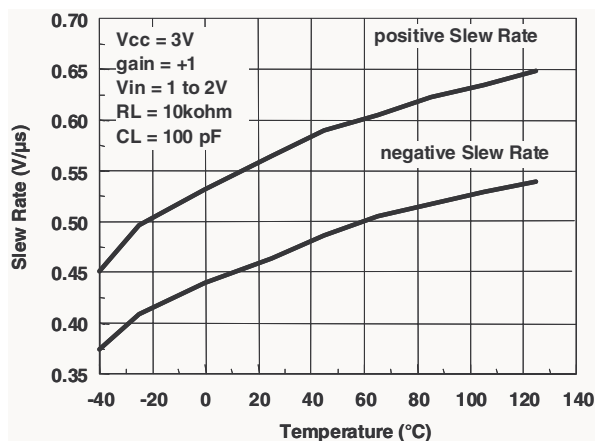
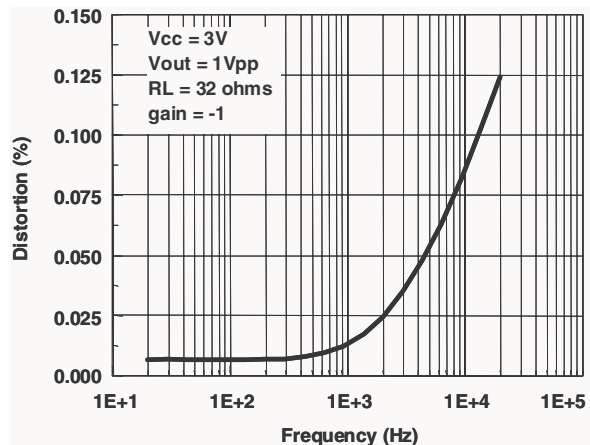

Figure 18. Distortion vs. frequency



4 Package Mechanical Data

In order to meet environmental requirements, ST offers these devices in ECOPACK[®] packages. These packages have a Lead-free second level interconnect. The category of second level interconnect is marked on the package and on the inner box label, in compliance with JEDEC Standard JESD97. The maximum ratings related to soldering conditions are also marked on the inner box label. ECOPACK is an ST trademark. ECOPACK specifications are available at: www.st.com.

4.1 SO-8 Package

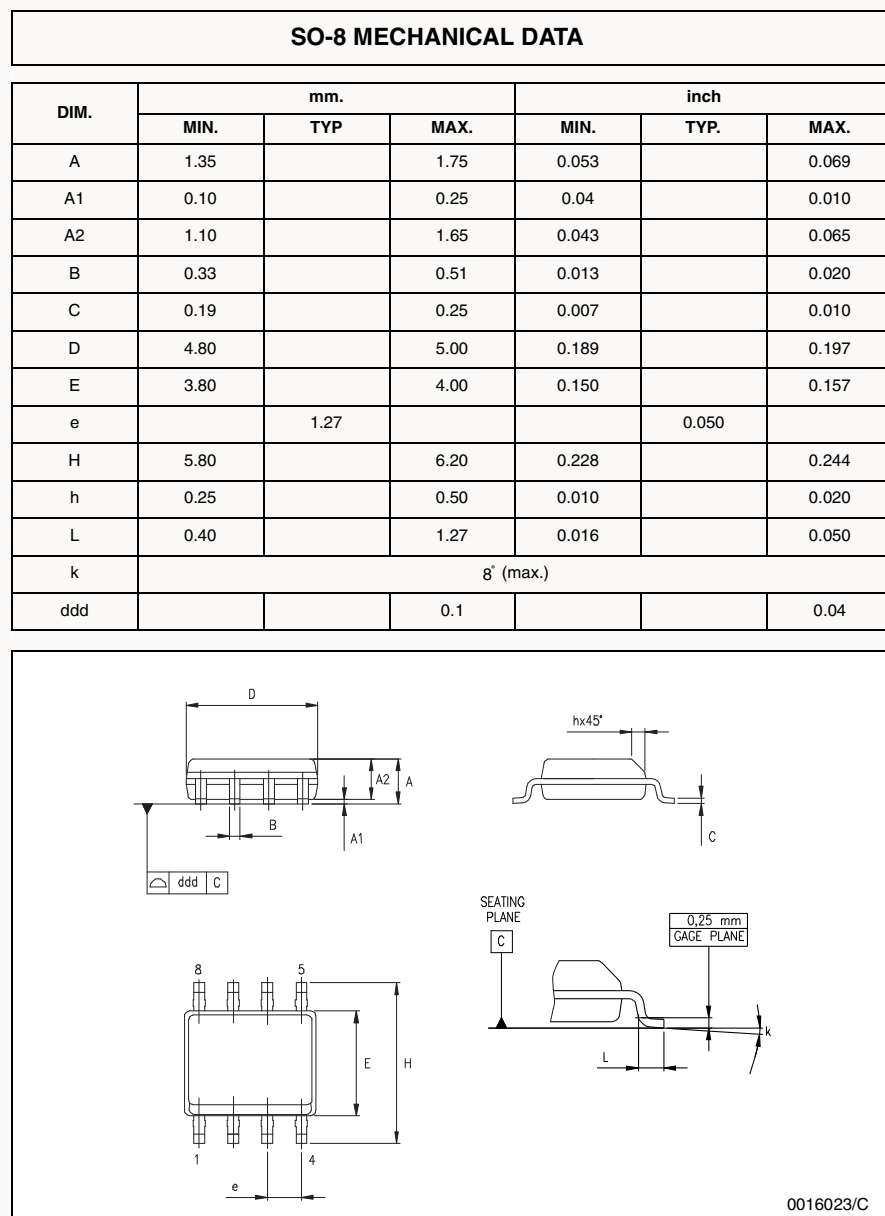

4.2 TSSOP8 Package

TSSOP8 MECHANICAL DATA						
DIM.	mm.			inch		
	MIN.	TYP.	MAX.	MIN.	TYP.	MAX.
A			1.2			0.047
A1	0.05		0.15	0.002		0.006
A2	0.80	1.00	1.05	0.031	0.039	0.041
b	0.19		0.30	0.007		0.012
c	0.09		0.20	0.004		0.008
D	2.90	3.00	3.10	0.114	0.118	0.122
E	6.20	6.40	6.60	0.244	0.252	0.260
E1	4.30	4.40	4.50	0.169	0.173	0.177
e		0.65			0.0256	
K	0°		8°	0°		8°
L	0.45	0.60	0.75	0.018	0.024	0.030
L1		1			0.039	

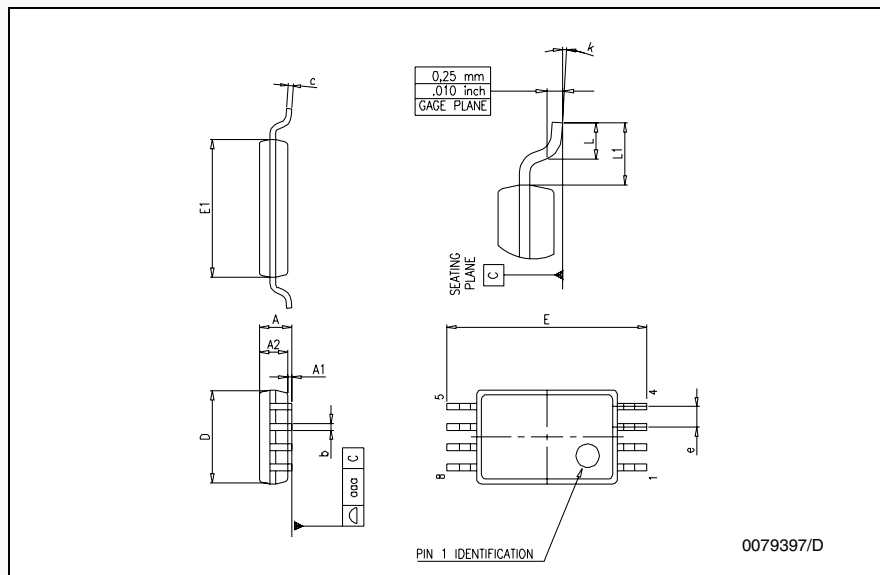

4.3 MiniSO-8 Package

miniSO-8 MECHANICAL DATA

DIM.	mm.			inch		
	MIN.	TYP.	MAX.	MIN.	TYP.	MAX.
A			1.1			0.043
A1	0.05	0.10	0.15	0.002	0.004	0.006
A2	0.78	0.86	0.94	0.031	0.031	0.037
b	0.25	0.33	0.40	0.010	0.13	0.013
c	0.13	0.18	0.23	0.005	0.007	0.009
D	2.90	3.00	3.10	0.114	0.118	0.122
E	4.75	4.90	5.05	0.187	0.193	0.199
E1	2.90	3.00	3.10	.0114	0.118	0.122
e		0.65			0.026	
K	0°		6°	0°		6°
L	0.40	0.55	0.70	0.016	0.022	0.028
L1			0.10			0.004

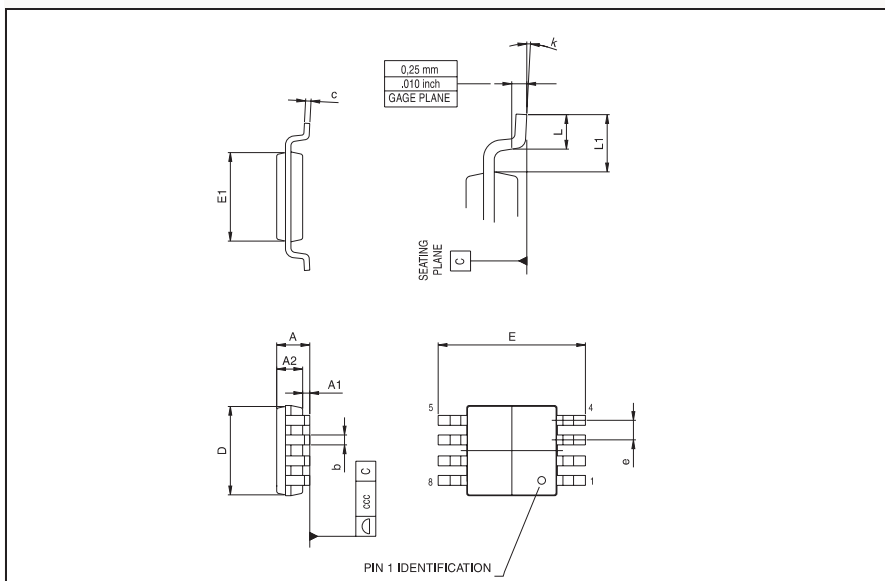

4.4 SO-14 Package

SO-14 MECHANICAL DATA						
DIM.	mm.			inch		
	MIN.	TYP.	MAX.	MIN.	TYP.	MAX.
A			1.75			0.068
a1	0.1		0.2	0.003		0.007
a2			1.65			0.064
b	0.35		0.46	0.013		0.018
b1	0.19		0.25	0.007		0.010
C		0.5			0.019	
c1	45° (typ.)					
D	8.55		8.75	0.336		0.344
E	5.8		6.2	0.228		0.244
e		1.27			0.050	
e3		7.62			0.300	
F	3.8		4.0	0.149		0.157
G	4.6		5.3	0.181		0.208
L	0.5		1.27	0.019		0.050
M			0.68			0.026
S	8° (max.)					

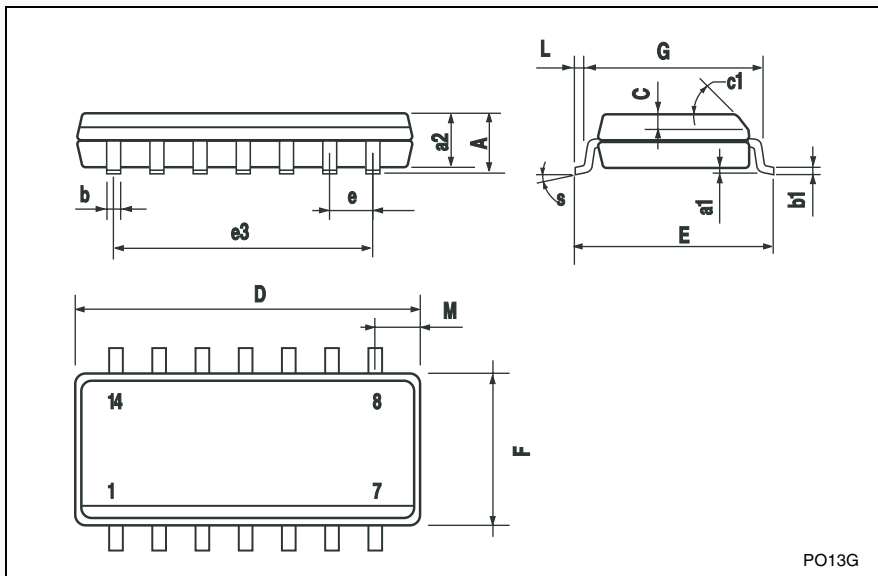

PO13G

4.5 TSSOP14 Package

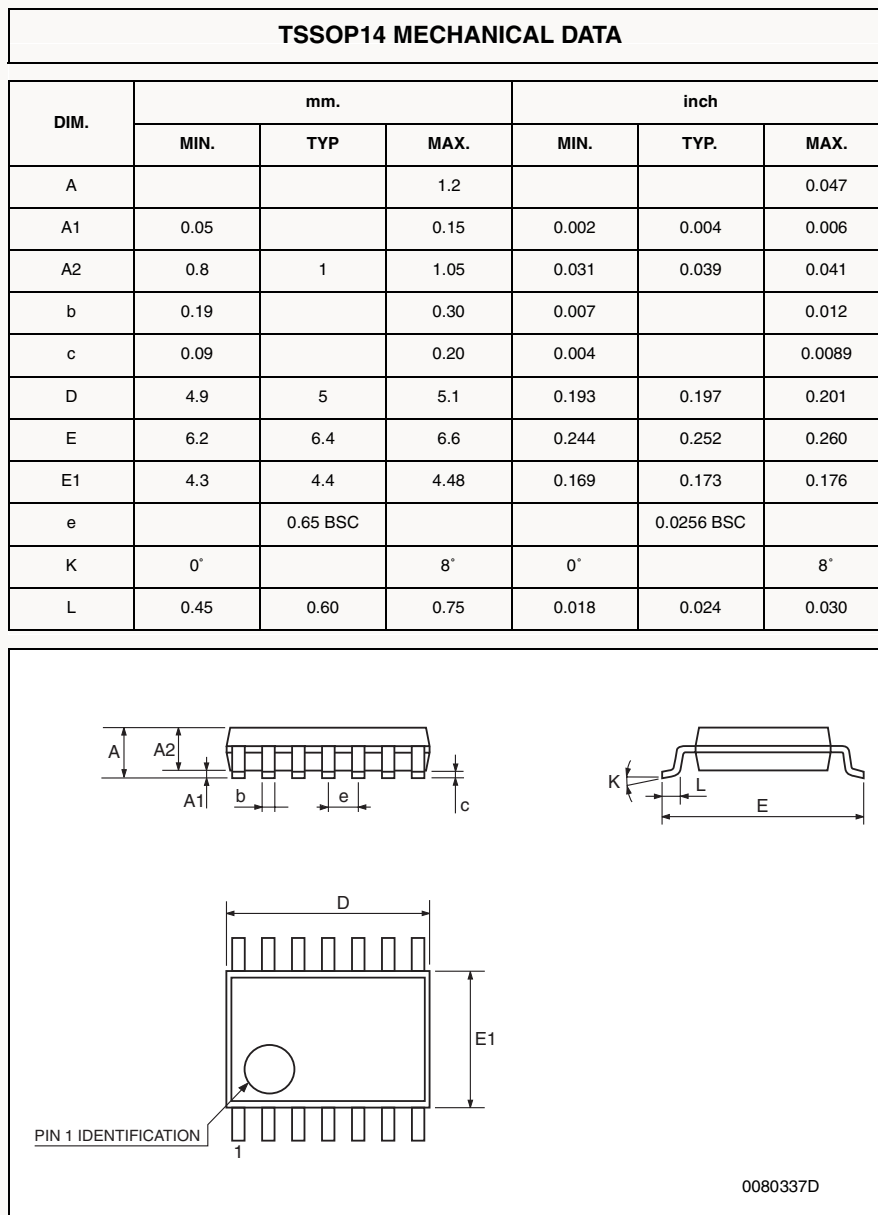

4.6 SOT23-5 Package

SOT23-5L MECHANICAL DATA

DIM.	mm.			mils		
	MIN.	TYP.	MAX.	MIN.	TYP.	MAX.
A	0.90		1.45	35.4		57.1
A1	0.00		0.15	0.0		5.9
A2	0.90		1.30	35.4		51.2
b	0.35		0.50	13.7		19.7
C	0.09		0.20	3.5		7.8
D	2.80		3.00	110.2		118.1
E	2.60		3.00	102.3		118.1
E1	1.50		1.75	59.0		68.8
e		0.95			37.4	
e1		1.9			74.8	
L	0.35		0.55	13.7		21.6

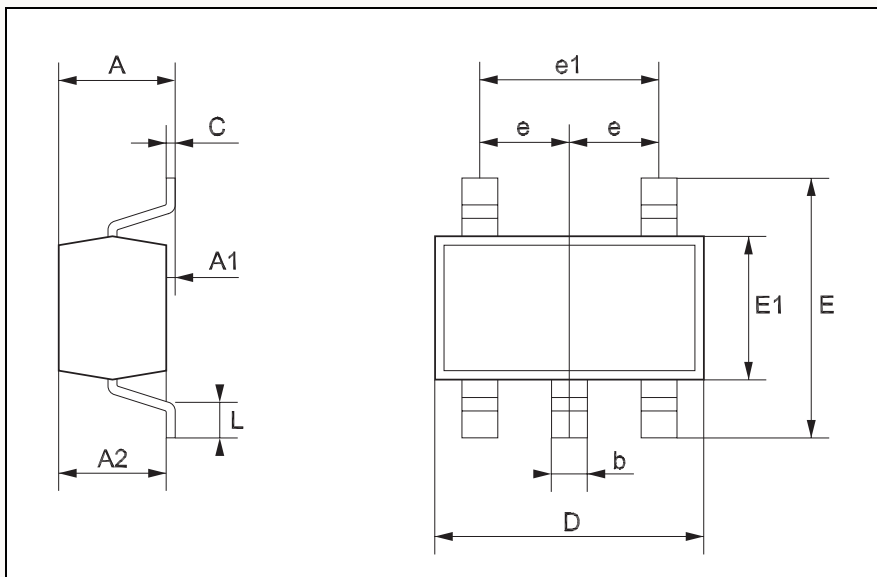

5 Revision History

Table 5. Document revision history

Date	Revision	Changes
Aug. 2005	1	– First Release - Products in full production
Sept. 2005	2	– Addition of TS321A/TS324A/TS358A data in tables in <i>Chapter 3: Electrical Characteristics on page 4.</i> – Minor formatting and grammatical changes.
Dec. 2005	3	– Missing PPAP references inserted see <i>Table 1: Order Codes on page 2.</i>

Information furnished is believed to be accurate and reliable. However, STMicroelectronics assumes no responsibility for the consequences of use of such information nor for any infringement of patents or other rights of third parties which may result from its use. No license is granted by implication or otherwise under any patent or patent rights of STMicroelectronics. Specifications mentioned in this publication are subject to change without notice. This publication supersedes and replaces all information previously supplied. STMicroelectronics products are not authorized for use as critical components in life support devices or systems without express written approval of STMicroelectronics.

The ST logo is a registered trademark of STMicroelectronics.
All other names are the property of their respective owners

© 7 STMicroelectronics - All rights reserved

STMicroelectronics group of companies

Australia - Belgium - Brazil - Canada - China - Czech Republic - Finland - France - Germany - Hong Kong - India - Israel - Italy - Japan - Malaysia - Malta - Morocco - Singapore - Spain - Sweden - Switzerland - United Kingdom - United States of America

www.st.com