

Cree® PLCC2 1-in-1 SMD LED CLM3C-RKW/AKW

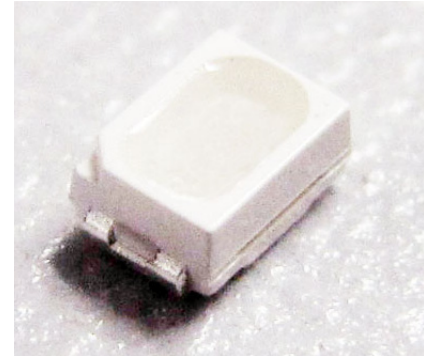

PRODUCT DESCRIPTION

SMD LEDs is packaged in the industry standard package. These LEDs have high reliability performance and are designed to work under a wide range of environmental conditions.

This high reliability feature makes them ideally suited to be used under illumination application conditions.

Its wide viewing angle makes these LEDs ideally suited for channel letter, or general backlighting and illumination applications. The flat top emitting surface makes it easy for these LEDs to mate with light pipes.

FEATURES

- Size (mm): 2.7 x 2.0
- Color and Typical Dominant Wavelength:
Red (624nm)
Amber (591nm)
- Luminous Intensity (mcd)
CLM3C-RKW: (560 - 1400)
CLM3C-AKW: (355 - 900)
- Viewing angle: 120 degree
- Lead-Free
- RoHS Compliant

APPLICATIONS

- Light Strip
- Channel Letter
- Architectural Lighting

ABSOLUTE MAXIMUM RATINGS ($T_A = 25^\circ\text{C}$)

Items	Symbol	Absolute Maximum Rating	Unit
		RKW/AKW	
Forward Current	I_F	50	mA
Peak Forward Current ^{Note}	I_{FP}	200	mA
Reverse Voltage	V_R	5	V
Power Dissipation	P_D	130	mW
Operation Temperature	T_{opr}	-40 ~ +100	$^\circ\text{C}$
Storage Temperature	T_{stg}	-40 ~ +100	$^\circ\text{C}$
Junction Temperature	T_J	110	$^\circ\text{C}$
Junction/Ambient	R_{THJA}	450	$^\circ\text{C}/\text{W}$
Junction/Solder Point	R_{THJS}	300	$^\circ\text{C}/\text{W}$
Electrostatic Discharge Classification (MIL-STD-883E)	ESD	Class 2	

Note: Pulse width ≤ 0.1 msec, duty $\leq 1/10$.

TYPICAL ELECTRICAL & OPTICAL CHARACTERISTICS ($T_A = 25^\circ\text{C}$)

Characteristics	Color	Symbol	Condition	Unit	Minimum	Typical	Maximum
Forward Voltage	RKW/AKW	V_F	$I_F = 20$ mA	V		2.1	2.6
Reverse Current	RKW/AKW	I_R	$V_R = 5$ V	μA			10
Dominant Wavelength	RKW	λ_D	$I_F = 20$ mA	nm	618	624	630
	AKW	λ_D	$I_F = 20$ mA	nm	584	591	596
Luminous Intensity	RKW	I_V	$I_F = 20$ mA	mcd	560	740	
	AKW	I_V	$I_F = 20$ mA	mcd	355	700	
50% Power Angle	RKW/AKW	$2\theta_{1/2}$	$I_F = 20$ mA	deg		120	

INTENSITY BIN LIMIT ($I_F = 20 \text{ mA}$)

Red (CLM3C-RKW)

Bin Code	Min.(mcd)	Max.(mcd)
Ub	560	710
Va	710	900
Vb	900	1120
Wa	1120	1400

Amber (CLM3C-AKW)

Bin Code	Min.(mcd)	Max.(mcd)
Tb	355	450
Ua	450	560
Ub	560	710
Va	710	900

Tolerance of measurement of luminous intensity is $\pm 10\%$.

COLOR BIN LIMIT ($I_F = 20 \text{ mA}$)

Red (CLM3C-RKW)

Bin Code	Min.(nm)	Max.(nm)
RA	618	630

Amber (CLM3C-AKW)

Bin Code	Min.(nm)	Max.(nm)
A2	584	587
A3	587	590
A4	590	593
A5	593	596

Tolerance of measurement of dominant wavelength is $\pm 1 \text{ nm}$.

ORDER CODE TABLE*

Color	Kit Number	Viewing Angle	Luminous Intensity (mcd)		Dominant Wavelength			
			Min.	Max.	Color Bin	Min. (nm)	Color Bin	Max. (nm)
Red	CLM3C-RKW-CUbWAAA3	120	560	1400	RA	618	RA	630
Red	CLM3C-RKW-CUbVaAA3	120	560	900	RA	618	RA	630
Red	CLM3C-RKW-CVaVbAA3	120	710	1120	RA	618	RA	630

Color	Kit Number	Viewing Angle	Luminous Intensity (mcd)		Dominant Wavelength			
			Min.	Max.	Color Bin	Min. (nm)	Color Bin	Max. (nm)
Amber	CLM3C-AKW-CTbVa253	120	355	900	A2	584	A5	596
Amber	CLM3C-AKW-CUbVa353	120	560	900	A3	587	A5	596

Notes:

1. The above kit numbers represent order codes that include multiple intensity-bin and color-bin codes. Only one intensity-bin code and one color-bin code will be shipped on each bulk. Single intensity-bin code and single color-bin codes will not be orderable.
2. Please refer to the "Cree LED Lamp Reliability Test Standards" document for reliability test conditions.
3. Please refer to the "Cree LED Lamp Soldering & Handling" document for information about how to use this LED product safely.

GRAPHS

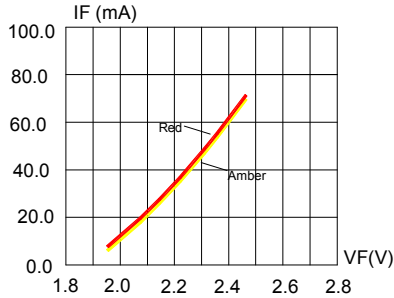

FIG. 1 FORWARD CURRENT VS. FORWARD VOLTAGE.

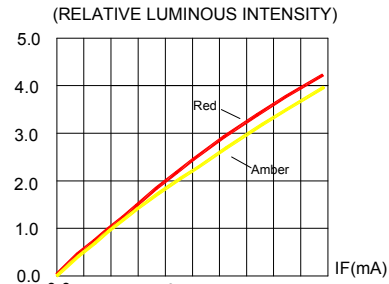

FIG. 2 RELATIVE LUMINOUS INTENSITY VS. FORWARD CURRENT

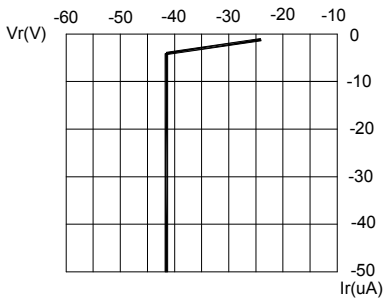

FIG. 3 RED&AMBER REVERSE CURRENT VS. REVERSE VOLTAGE.

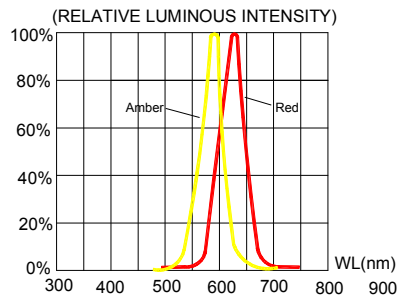

FIG. 4 RELATIVE LUMINOUS INTENSITY VS. WAVELENGTH.

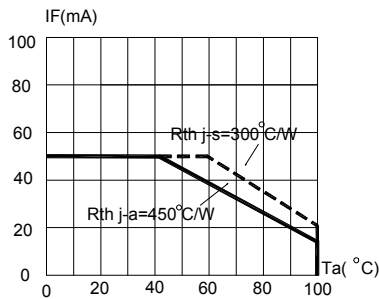

FIG. 5 RED&AMBER MAXIMUM FORWARD DC CURRENT VS AMBIENT TEMPERATURE ($T_{jmax}=110^{\circ}C$)

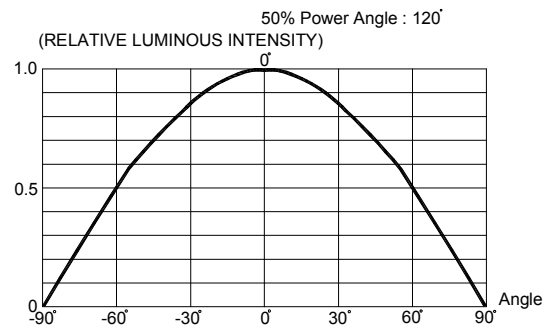
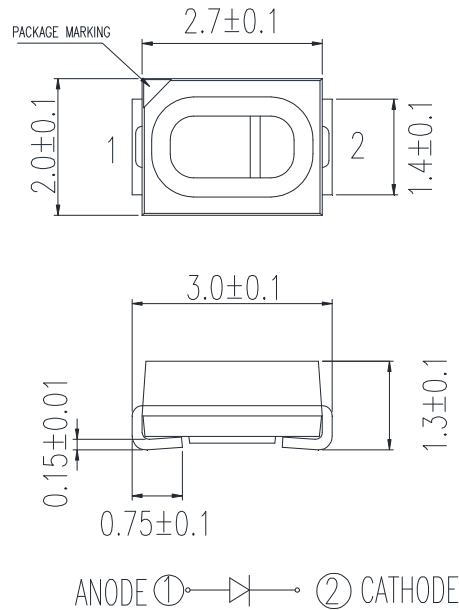

FIG. 6 FAR FIELD PATTERN

The above data are collected from statistical figures that do not necessarily correspond to the actual parameters of each single LED. Hence, these data will be changed without further notice.

MECHANICAL DIMENSIONS

All dimensions are in mm.



NOTES

RoHS Compliance

The levels of environmentally sensitive, persistent biologically toxic (PBT), persistent organic pollutants (POP), or otherwise restricted materials in this product are below the maximum concentration values (also referred to as the threshold limits) permitted for such substances, or are used in an exempted application, in accordance with EU Directive 2002/95/EC on the restriction of the use of certain hazardous substances in electrical and electronic equipment (RoHS), as amended through April 21, 2006.

Vision Advisory Claim

Users should be cautioned not to stare at the light of this LED product. The bright light can damage the eye.

KIT NUMBER SYSTEM

Cree LED lamps are tested and sorted into performance bins. A bin is specified by ranges of color, forward voltage, and brightness. Sorted LEDs are packaged for shipping in various convenient options. Please refer to the "Cree LED Lamp Packaging Standard" document for more information about shipping and packaging options.

Cree LEDs are sold by order codes in combinations of bins called kits. Order codes are configured in the following manner:

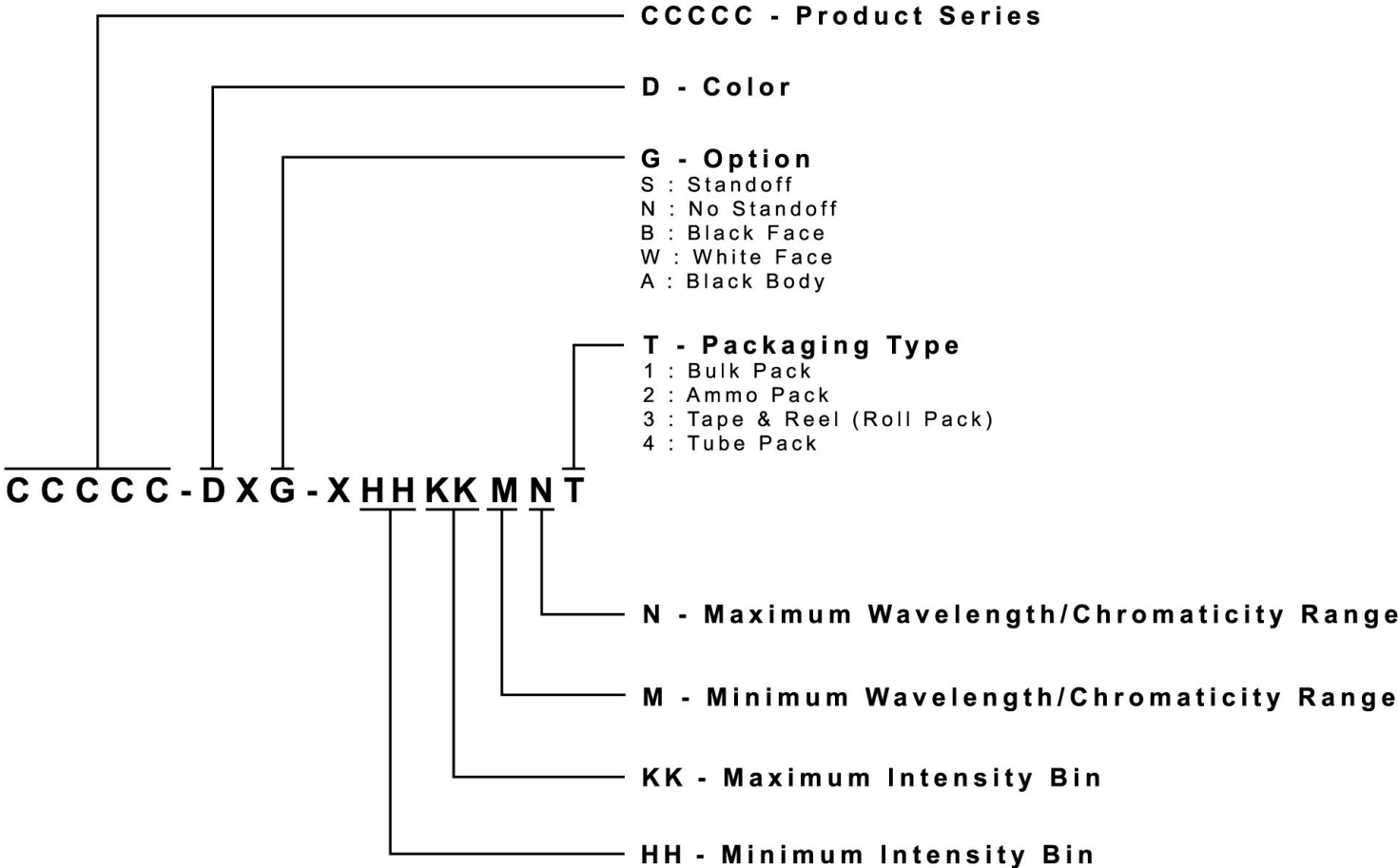

PACKAGING

- The boxes are not water resistant and they must be kept away from water and moisture.
- The LEDs are packed in cardboard boxes after packaging in normal or anti-electrostatic bags.
- Cardboard boxes will be used to protect the LEDs from mechanical shocks during transportation.
- The reel pack is applied in SMD LED.
- Max 2500 pcs per reel.

