

# Datasheet

## 5 Way Male Cable Mount Loudspeaker Connector, 20A

RS Stock 460-266



### Dimensions: (mm)

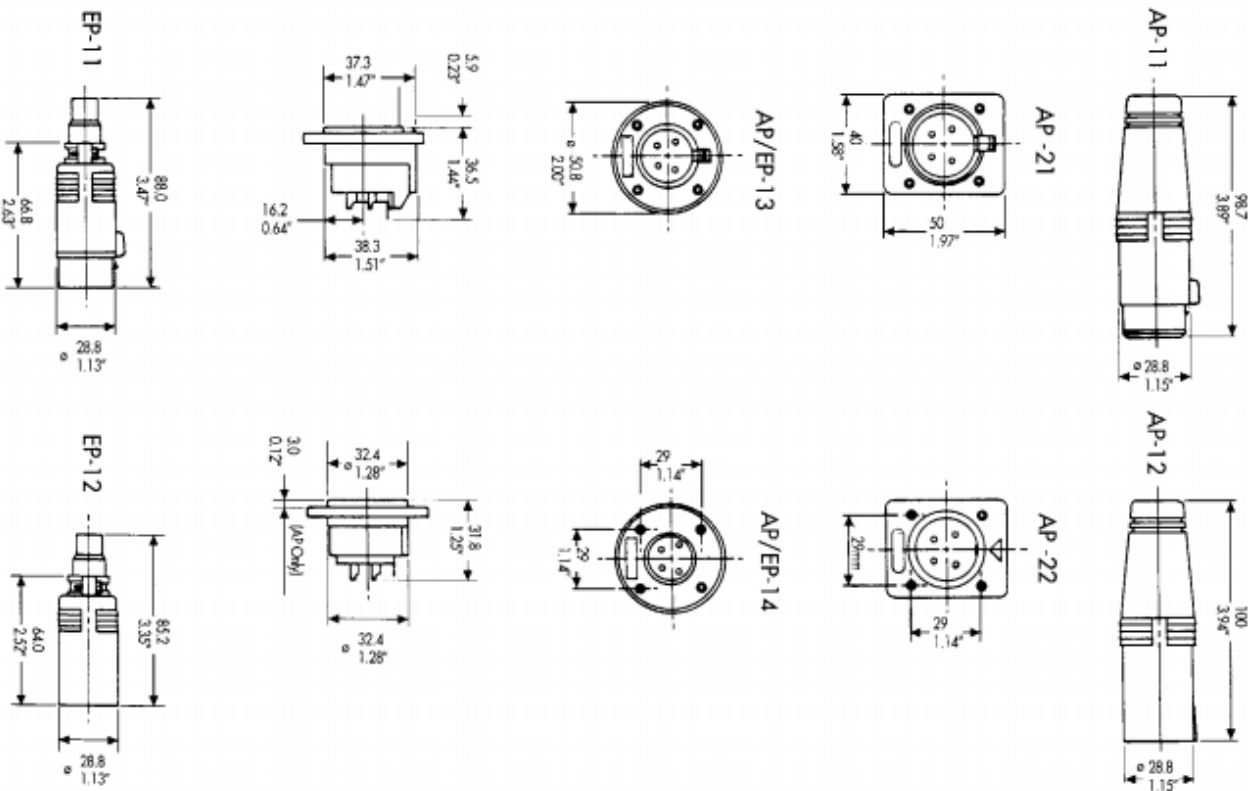



**AP SERIES**

The AP Series of audio connectors manufactured from tough, durable thermoplastic, capable of withstanding the roughest treatment.

Enlarged cable entry is suitable for cable from 11 mm (0.43") to 17mm (0.67") and the convenient internal grub screw cable clamping system makes the AP connectors quick and easy to assemble.

A specially designed cable bushing serves to minimise cable bending stress and prevent moisture entering the connector.

The panel mount versions are sealed for simplified loudspeaker cabinet design.

The AP Series is available in four different contact layouts (4, 5, 6 & 8) and is completely intermateable with the EP Series.

**EP SERIES**

The EP Series incorporates a rugged zinc diecast shell to give it maximum durability when used in tough situations. Five different contact configurations (3,4,5,6 or 8) are available.

The EP straight cord plug cable flex relief design minimises cable bend stress at point of entry into the connector housing. Two different cable relief sizes are available to ensure firm cable support for both large and small cable diameters. The cable clamp is capable of supporting cables from 9mm (0.35") to 16mm (0.63") in diameter.

LINE FEMALE	LINE MALE	SHELL	COMMENTS
AP*-11	AP*-12	Thermoplastic	4, 5, 6 & 8 Machined contact arrangements - bright tin plating
<b>FEMALE RECEPTACLE</b>	<b>MALE RECEPTACLE</b>		
AP*-21 AP*-13	AP*-22 AP*-14	Thermoplastic Thermoplastic	4, 5, 6 & 8 Machined contact arrangements - bright tin plating
<b>LINE FEMALE</b>	<b>LINE MALE</b>		
EP*-11P	EP*-12	Diecast - Nickel or Black Finish	3, 4, 5, 6 & 8 Machined contact arrangements - bright tin plating Add suffix B for Black finish
<b>FEMALE RECEPTACLE</b>	<b>MALE RECEPTACLE</b>		
EP*-13P	EP*-14	Diecast - Nickel or Black Finish	3, 4, 5, 6 & 8 Machined contact arrangements - bright tin plating Add suffix B for Black finish

**Standard Data**

	AP	EP
Cable OD Range	11mm to 17mm (0.43" to 0.67")	9mm to 16mm (0.35" to 0.63")
Cable Retention Force	Typically 22 to 44Kg (50 to 100lb) (Depending on Cable Material and Diameter)	
Retention Method	2 Opposing Plastic Screws on 11 & 12 only	Metal Saddle Clamp
Shell	Modified PPE Resin Black	Diecast Zinc Alloy Satin Nickel or Black Polyester
Insulators	UL94V-0 PBT Resin	UL94V-0 PBT Resin
Contacts	Precision machined Brass - Bright Tin - Solder Cup	
Cable Bushing	Silicon Rubber	UL94HB Thermoplastic Elastomer
Operating Temperature	-25°C to +75°C	-25°C to +75°C
Contact Resistance	≤ 3mΩ	≤ 3mΩ
Insulation Resistance	≥ 10 <sup>3</sup> MegΩ	≥ 10 <sup>3</sup> MegΩ
Connector Insertion / Withdrawal Force	≥ 10N / ≤ 30N	

**AP/EP Series**

Panel cut-out data

EP 13/AP 13/AP 21

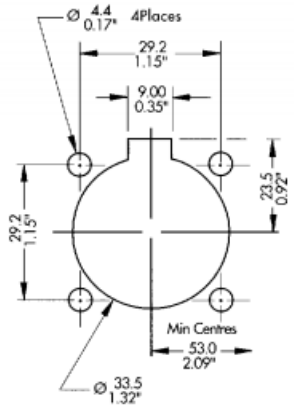

EP 14/AP 14/AP 22

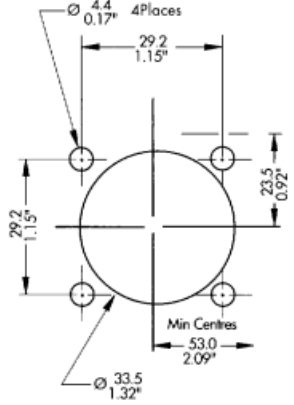

**AP / EP Series Arrangements**

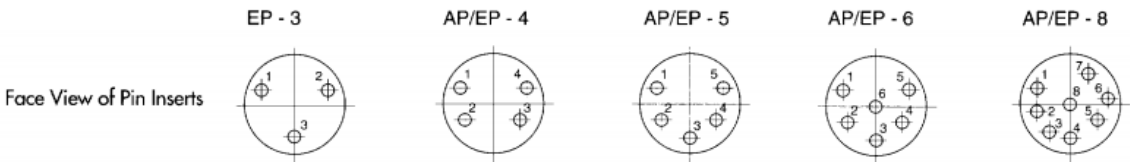

	EP - 3	AP/EP - 4	AP/EP - 5	AP/EP - 6	AP/EP - 8
Test Voltage AC RMS	2400	3000	1600	1600	1300
Service Voltage RMS	460	660	200	200	100
Current Ratings Amps	20	20	20	20	15
AWG Stranded Wire	12AWG	12AWG	12AWG	12AWG	14AWG

(Not suitable for domestic applications above 50V)