



**TELEDYNE
RELAYS**

A Teledyne Technologies Company

**SURFACE MOUNT,
HIGH REPEATABILITY,
SIGNAL INTEGRITY TO 10Gbps
BROADBAND TO-5 RELAYS
DPDT**

**SERIES
GRF300
GRF303**

SERIES DESIGNATION	RELAY TYPE
GRF300	Repeatable, Signal Integrity, RF TO-5 relay
GRF303	Sensitive, Repeatable, Signal Integrity, RF TO-5 relay

INTERNAL CONSTRUCTION

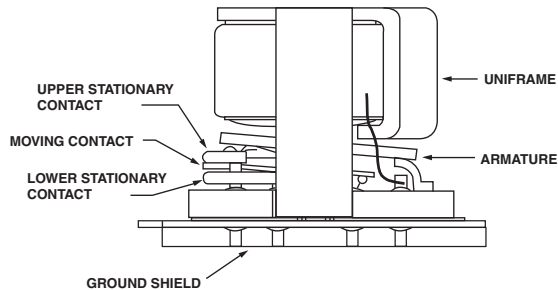

DESCRIPTION

The ultraminiature GRF300 and GRF303 relays are designed to provide a practical surface-mount solution with improved RF signal repeatability over the frequency range. GRF300 and GRF303 relays feature a unique ground shield that isolates and shields each lead to ensure excellent contact-to-contact and pole-to-pole isolation. **The GRF300/GRF303 version with the improved ground connections can push the performance up into the 10Gbps data rates for digital signal integrity applications.** This ground shield provides a ground interface that results in improved high-frequency performance as well as parametric repeatability. The GRF300 and GRF303 extend performance advantages over similar RF devices that simply offer formed leads for surface mounting. These relays are engineered for use in RF attenuator, RF switch matrices, ATE and other applications that require dependable high frequency signal fidelity and performance.

The GRF300 and GRF303 feature:

- High repeatability
- Broader bandwidth
- Metal enclosure for EMI shielding
- High isolation between control and signal paths
- High resistance to ESD

The following unique construction features and manufacturing techniques provide excellent robustness to environmental extremes and overall high reliability:

- Uniframe motor design provides high magnetic efficiency and mechanical rigidity
- Minimum mass components and welded construction provide maximum resistance to shock and vibration
- Advanced cleaning techniques provide maximum assurance of internal cleanliness
- Gold-plated precious metal alloy contacts ensure reliable switching
- Hermetically sealed

ENVIRONMENTAL AND PHYSICAL SPECIFICATIONS

Temperature (Ambient)	Storage	-65°C to +125°C
	Operating	-55°C to +85°C
Vibration (General Note 1)		10 g's to 500 Hz
Shock (General Note 1)		30 g's, 6ms half sine
Enclosure		Hermetically sealed
Weight	GRF300	0.09 oz. (2.55g) max.
	GRF303	0.16 oz. (4.5g) max.

**SERIES GRF300 AND GRF303
TYPICAL SIGNAL INTEGRITY CHARACTERISTICS**

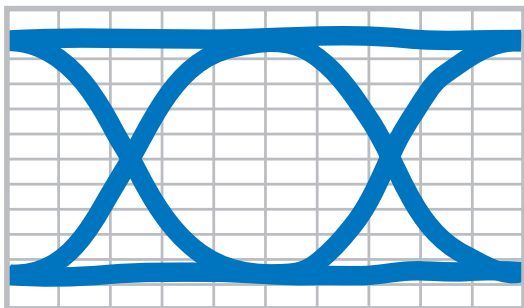

- i. $Rt_{OFF} = 31.1 \text{ pS}$.
- ii. $Ft_{OFF} = 32 \text{ pS}$.
- iii. $V_{OFF} = 511.95 \text{ mVpp}$.

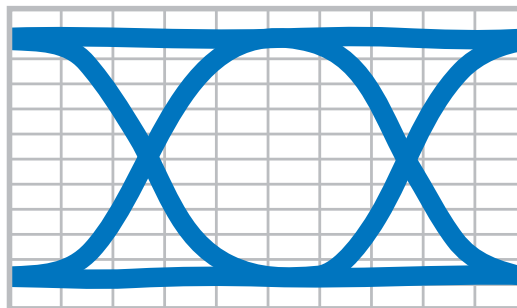

- i. $Rt_{ON} = 30.2 \text{ pS}$.
- ii. $Ft_{ON} = 30.7 \text{ pS}$.
- iii. $V_{ON} = 512.54 \text{ mV}$.

MEASUREMENTS NOTES

Measurements were made using the Agilent AG86100 Digital Communication Analyzer with 12GHz-pattern generator and 10GHz-clock source. The relay was mounted on an evaluation board. Two RF 3-foot long cables were used for measurements.

Pattern Generator Settings

- $2^{31}-1$ PRBS signal
- 10Gbps data rate
- Data amplitude of 500mVpp

Oscilloscope Settings

- Measurement threshold set to 20%–80%

NRZ Eye/Mask mode measurements: rise time, fall time, eye ramp and bit rate

GRF303 Insertion Loss

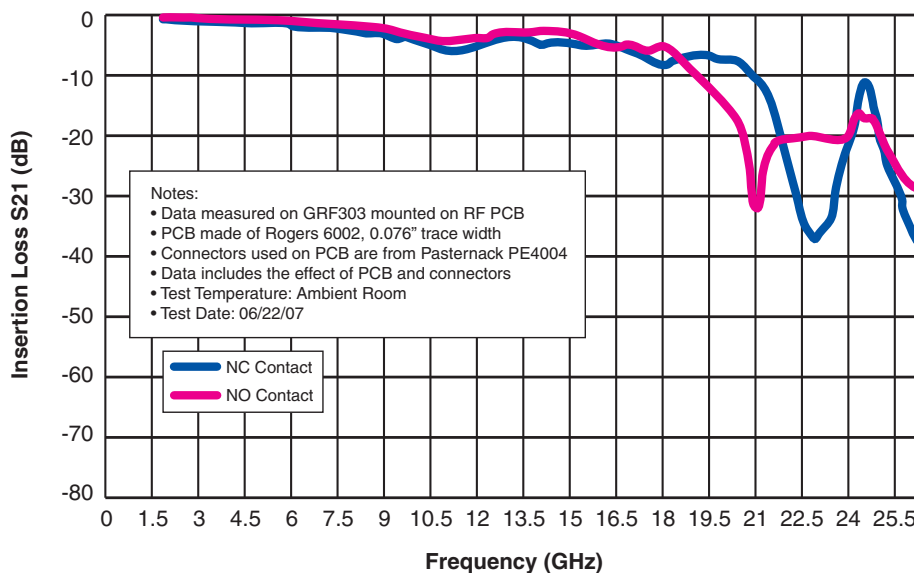

Note: For Insertion Loss measurements in lower bandwidth (<6GHz) see chart on the next page.

**SERIES GRF300 AND GRF303
TYPICAL RF CHARACTERISTICS (See RF Notes)**

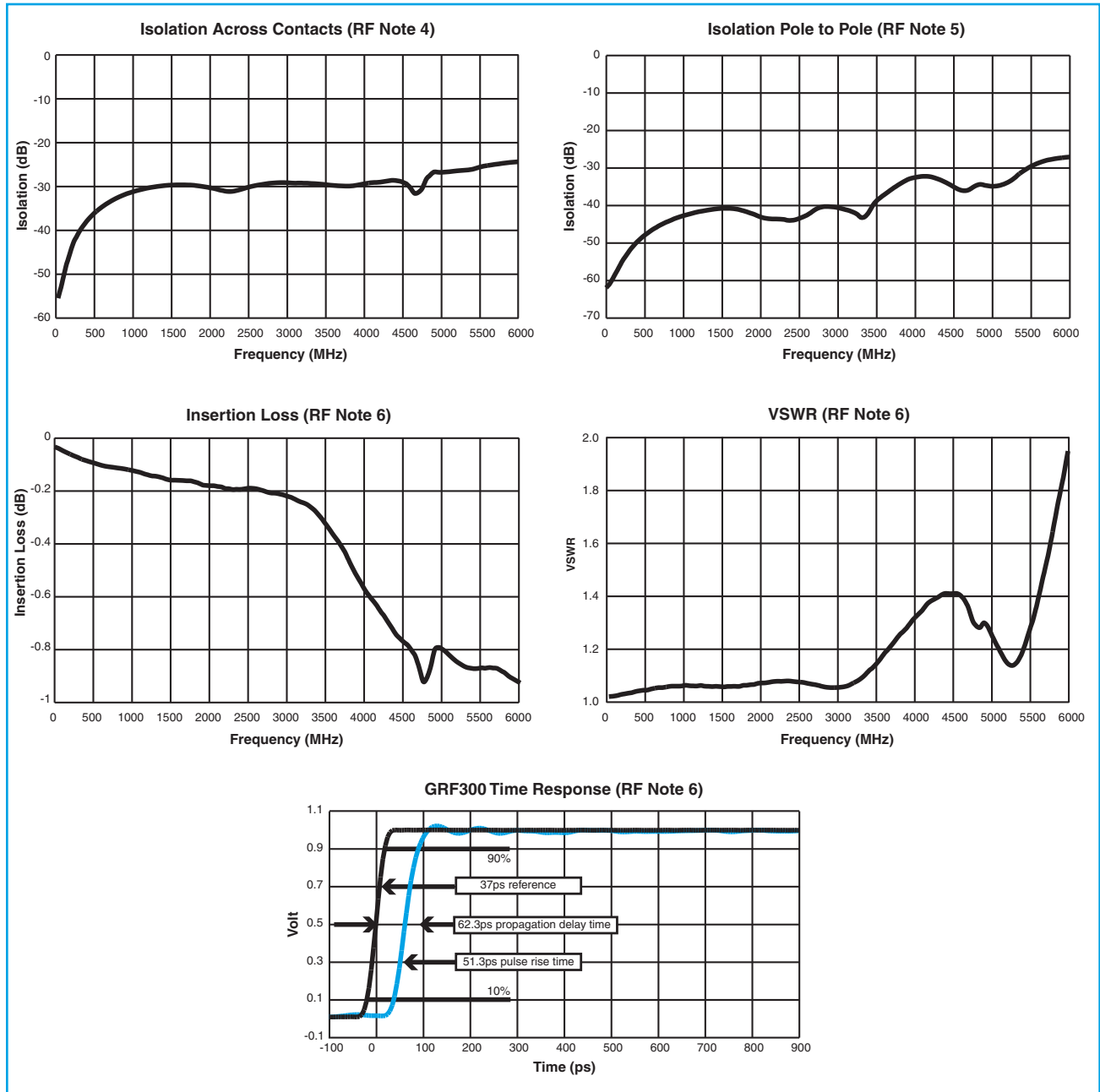

RF NOTES

1. Test conditions:
 - a. Fixture: .031" copper clad, reinforced PTFE, RT/duroid® 6002 with SMA connectors. (RT/duroid® is a registered trademark of Rogers Corporation.)
 - b. RF ground shield is soldered to PCB RF ground plane.
 - c. Room ambient temperature.
 - d. Terminals not tested were terminated with 50-ohm load.
 - e. Contact signal level: -10 dBm.
 - f. No. of test samples: 2.
2. Data presented herein represents typical characteristics and is not intended for use as specification limits.
3. Data is per pole, except for pole-to-pole data.
4. Data is the average from readings taken on all open contacts.
5. Data is the average from readings taken on poles with coil energized and de-energized.
6. Data is the average from readings taken on all closed contacts.
7. Test fixture effect de-embedded from frequency and time response data.

SERIES GRF300 AND GRF303
TYPICAL RF INSERTION LOSS REPEATABILITY CHARACTERISTICS
 (See RF Insertion Loss Repeatability Notes)

REPEATABILITY CHARACTERISTICS GRF300 RELAYS

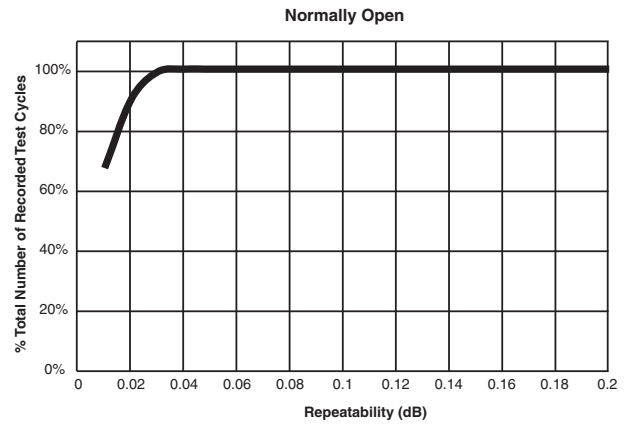
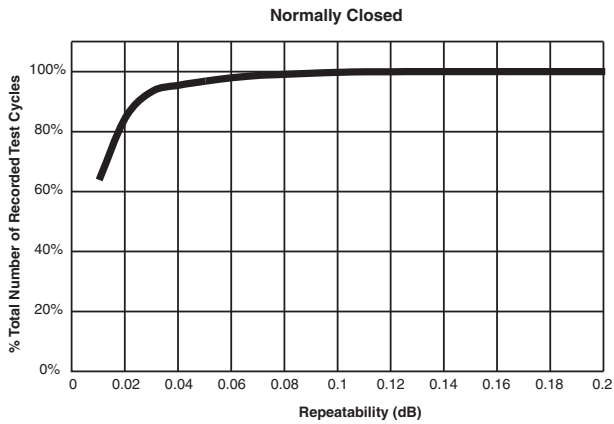

REPEATABILITY CHARACTERISTICS GRF303 RELAYS

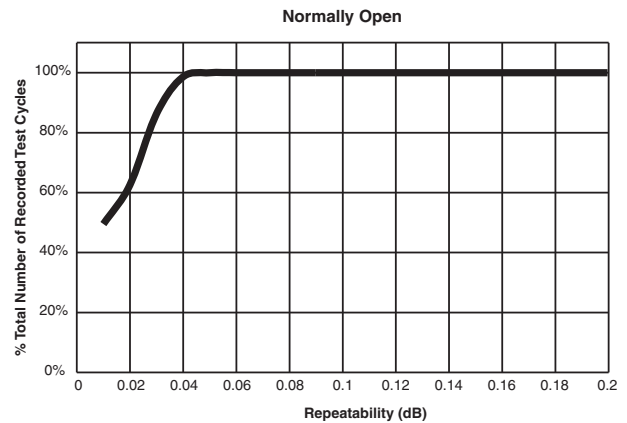
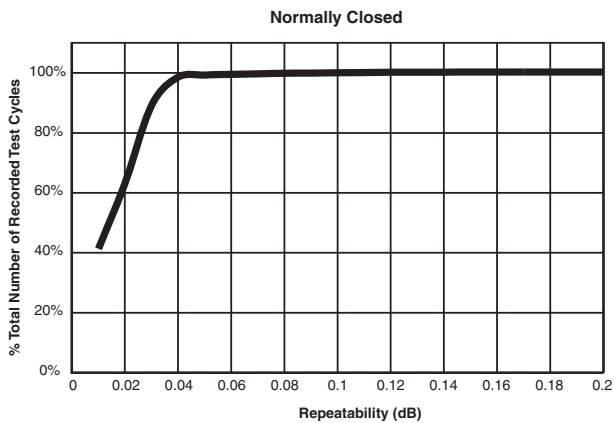

RF INSERTION LOSS REPEATABILITY NOTES

1. Test conditions:
 - a. Fixture: .031" copper clad, reinforced PTFE, RT/duroid® 6002 with SMA connectors. (RT/duroid® is a registered trademark of Rogers Corporation.)
 - b. Test performed at room ambient temperature.
 - c. Contact signal level: 20dBm.
2. Data presented herein represents typical characteristics and is not intended for use as specification limits.
3. Insertion loss repeatability measured over frequency range from 50MHz to 4GHz.

SERIES GRF300 AND GRF303
GENERAL ELECTRICAL SPECIFICATIONS (@25°C unless otherwise noted) (Notes 2 & 3)

Contact Arrangement		2 Form C (DPDT)
Rated Duty		Continuous
Contact Resistance		0.15 Ω max.
Contact Load Rating		Resistive: 1Amp/28Vdc Low level: 10 to 50 μA @ 10 to 50mV
Contact Life Ratings		10,000,000 cycles (typical) at low level
Coil Operating Power	GRF300-5	500 mW typical @ nominal rated voltage
	GRF300-12	370 mW typical @ nominal rated voltage
	GRF303-5	250 mW typical @ nominal rated voltage
	GRF303-12	169 mW typical @ nominal rated voltage
Operate Time	GRF300	4.0 msec max.
	GRF303	6.0 msec max.
Release Time	GRF300	3.0 msec max.
	GRF303	3.0 msec max.
Intercontact Capacitance		0.4 pf typical
Insulation Resistance		1,000 MΩ min. between mutually isolated terminals
Dielectric Strength		350 Vrms/60Hz @ atmospheric pressure

DETAILED ELECTRICAL SPECIFICATIONS (@25°C)

BASE PART NUMBERS		GRF300-5 GRF303-5	GRF300-12 GRF303-12
Coil Voltage, Nominal (Vdc)		5.0	12.0
Coil Resistance (Ohms ±20%)	GRF300	50	390
	GRF303	100	850
Pick-up Voltage (Vdc, Max.)		3.6	9.0

GENERAL NOTES

1. Relays will exhibit no contact chatter in excess of 10 μsec or transfer in excess of 1 μsec.
2. Unless otherwise specified, parameters are initial values.
3. Relays may be subjected to 260°C, peak solder reflow temperature, 1 minute, 3 passes.
4. Butt-lead ends are coplanar within .003" (0.08mm).
5. Application notes available for PCB layout and mounting information.

OUTLINE DIMENSIONS

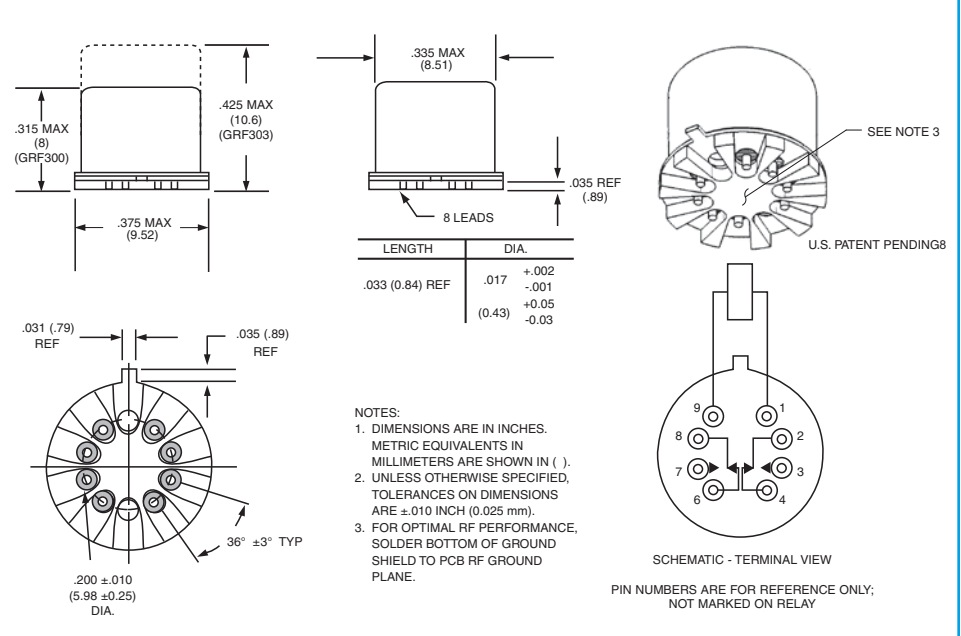

Appendix A: Spacer Pads

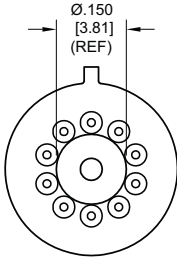
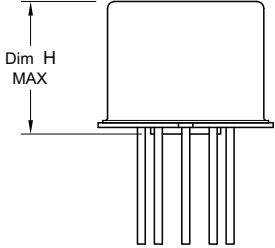
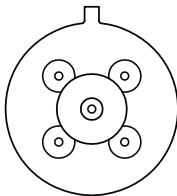
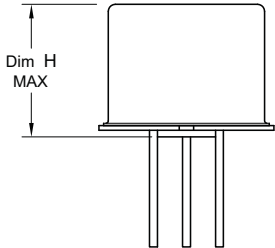
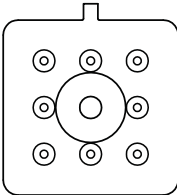
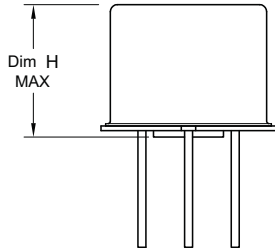
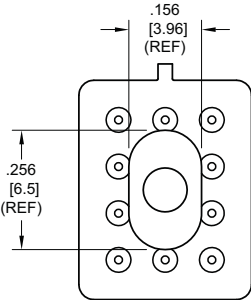
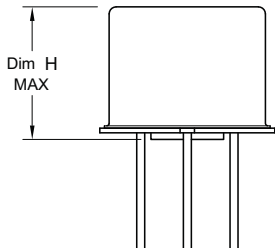
Pad designation and bottom view dimensions	Height	For use with the following:	Dim. H Max.
 <p style="text-align: center;">“M4” Pad for TO-5</p>		ER411T ER412, ER412D, ER412DD	.295 (7.49)
		712, 712D, 712TN, RF300, RF310, RF320	.300 (7.62)
		ER420, ER422D, ER420DD, 421, ER421D, ER421DD, ER422, ER422D, ER422DD, 722, 722D, RF341	.305 (7.75)
		ER431T, ER432T, ER432, ER432D, ER432DD	.400 (10.16)
		732, 732D, 732TN, RF303, RF313, RF323	.410 (10.41)
		RF312	.350 (8.89)
 <p style="text-align: center;">“M4” Pad for TO-5</p>		ER411, ER411D, ER411DD	.295 (7.49)
		ER431, ER431D, ER431DD	.400 (10.16)
		RF311	.300 (7.62)
		RF331	.410 (10.41)
 <p style="text-align: center;">“M4” Pad for Centigrid®</p>		172, 172D	.305 (7.75)
		ER114, ER114D, ER114DD, J114, J114D, J114DD	.300 (7.62)
		ER134, ER134D, ER134DD, J134, J134D, J134DD	.400 (10.16)
		RF100	.315 (8.00)
		RF103	.420 (10.67)
 <p style="text-align: center;">“M9” Pad for Centigrid®</p>		122C, A152	.320 (8.13)
		ER116C, J116C	.300 (7.62)
		ER136C, J136C	.400 (10.16)
		RF180	.325 (8.25)
		A150	.305 (7.75)

Notes:

1. Spacer pad material: Polyester film.
2. To specify an “M4” or “M9” spacer pad, refer to the mounting variants portion of the part numbering example in the applicable datasheet.
3. Dimensions are in inches (mm).
4. Unless otherwise specified, tolerance is $\pm .010$ (.25).
5. Add 10 m Ω to the contact resistance show in the datasheet.
6. Add 0.01 oz. (0.25 g) to the weight of the relay assembly shown in the datasheet.

Appendix A: Spreader Pads

Pad designation and bottom view dimensions	Height	For use with the following:	Dim. H Max.
<p>"M" Pad <u>5/</u> <u>6/</u> <u>9/</u></p>		ER411T, J411T, ER412, ER412D ER412DD, J412, J412D, J412DD ER412T, J412T	.388 (9.86)
		712, 712D, 712TN	.393 (9.99)
		ER431T, J431T, ER432, ER432D ER432DD, J432, J432D, J432DD ER432T, J432T	.493 (12.52)
		732, 732D, 732TN	.503 (12.78)
		ER420, J420, ER420D, J420D ER420DD, J420DD, ER421, J421 ER421D, J421D, ER421DD J422D, ER422DD, J422DD, 722	.398 (10.11)
<p>"M2" Pad <u>7/</u> <u>8/</u></p>		ER411T ER412, ER412D, ER412DD J412, J412D, J412DD	.441 (11.20)
		712, 712D	.451 (11.46)
		ER421, ER421D, ER421DD 722, 732D	.451 (11.46)
		ER431T ER432, ER432D, ER432DD	.546 (13.87)
		732, 732D	.556 (14.12)
<p>"M3" Pad <u>5/</u> <u>6/</u> <u>9/</u></p>		ER411, ER411D, ER411DD ER411TX ER412X, ER412DX, ER412DDX ER412TX	.388 (9.86)
		712X, 712DX, 712TNX	.393 (9.99)
		ER420X, ER420DX, ER420DDX ER421X, ER421DX, ER421DDX ER422X, ER422DX ER422DDX, 722X, 722DDX	.398 (10.11)
		ER431, ER431D, ER431DD ER431TX ER432X, ER432DX, ER432DDX ER432TX	.493 (12.52)
		732X, 732DX, 732TNX	.503 (12.78)

Notes:

1. Spreader pad material: Diallyl Phthalate.
2. To specify an "M", "M2" or "M3" spreader pad, refer to the mounting variants portion of the part number example in the applicable datasheet.
3. Dimensions are in inches (mm).
4. Unless otherwise specified, tolerance is $\pm .010$ " (0.25).
- 5/. Add 25 m Ω to the contact resistance shown in the datasheet.
- 6/. Add .01 oz. (0.25 g) to the weight of the relay assembly shown in the datasheet.
- 7/. Add 50 m Ω to the contact resistance shown in the datasheet.
- 8/. Add 0.025 oz (0.71 g) to the weight of the relay assembly shown in the datasheet.
- 9/. M3 pad to be used only when the relay has a center pin (e.g. ER411M3-12A, 722XM3-26.)

Appendix A: Ground Pin Positions

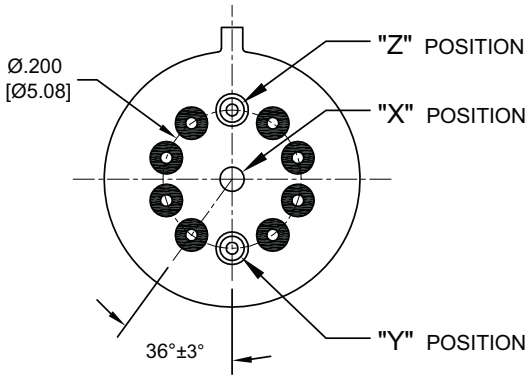

TO-5 Relays:

ER411T, ER412, ER412T, ER420, ER421, ER422,
ER431T, ER432, ER432T, 712, 712TN, 400H, 400K,
400V, RF300, RF303, RF341, RF312, RF310, RF313,
RF320, RF323

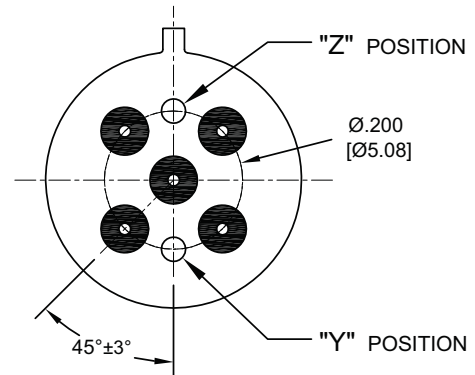

TO-5 Relays:

ER411, ER431, RF311, RF331

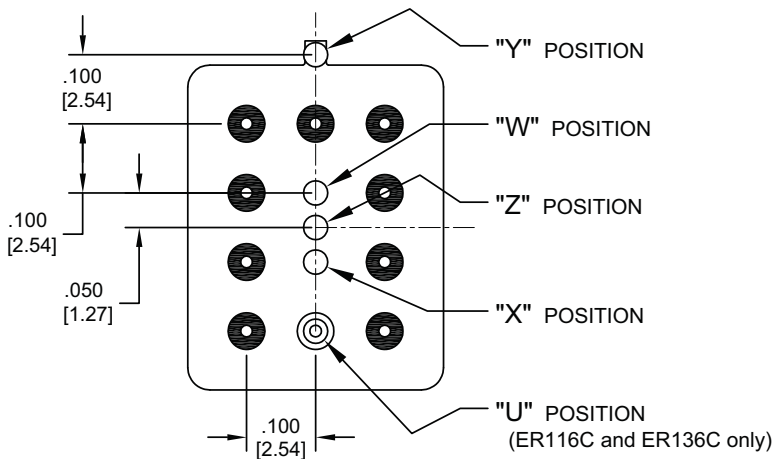

Centigrid® Relays:

RF180, ER116C, 122C, ER136C

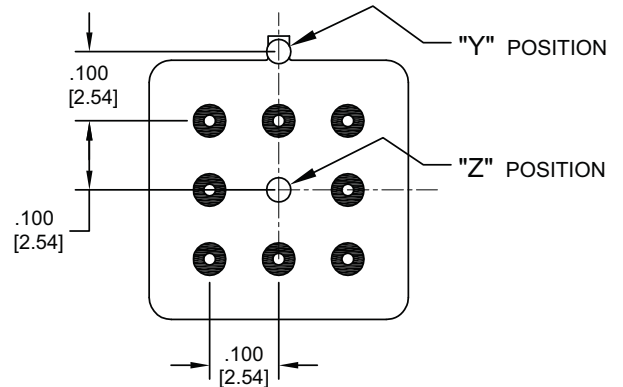

Centigrid® Relays:

RF100, RF103, ER114, ER134, 172

- Indicates ground pin position
- Indicates glass insulated lead position
- ◎ Indicates ground pin or lead position depending on relay type

NOTES

1. Terminal views shown
2. Dimensions are in inches (mm)
3. Tolerances: $\pm .010$ ($\pm .25$) unless otherwise specified
4. Ground pin positions are within $.015$ (0.38) dia. of true position
5. Ground pin head dia., 0.035 (0.89) ref: height 0.010 (0.25) ref.
6. Lead dia. 0.017 (0.43) nom.