



30 and 40 W - 10 Nm - Right-angle gearbox 801410 SNI10 Part number 80141004



- Output perpendicular to motor
- Ideal for short reduction ratios
- Ideal for very compact applications
- Silent operation
- Non-reversible movement at high ratios

	Type	With built-in electronic control	Without built-in control, with Hall effect sensors	Ratios (i)	Output speed (rpm) 24 V DC	Available torque (Nm)	Efficiency (%)
80141001	801410 SNI10	SNI10	-	5	440	0,36	-
80141002	801410 SNI10	SNI10	-	10	220	0,7	-
80141003	801410 SNI10	SNI10	-	20	110	1,5	-
80141004	801410 SNI10	SNI10	-	30	73	1,8	-
80141006	801410 SNI10	SNI10	-	50	44	2,4	-
CONTACT US	801410 SNI10	SNI10	-	5	440	0,416	-
CONTACT US	801410 SNI10	SNI10	-	10	220	0,768	-
CONTACT US	801410 SNI10	SNI10	-	20	110	1,7	-
CONTACT US	801410 SNI10	SNI10	-	30	73	2	-
CONTACT US	801410 SNI10	SNI10	-	50	44	2,7	-
CONTACT US	801410 SNI10	SNI10	-	5	400	0,5	-
CONTACT US	801410 SNI10	SNI10	-	10	200	1	-
CONTACT US	801410 SNI10	SNI10	-	20	100	2,3	-
CONTACT US	801410 SNI10	SNI10	-	30	67	2,6	-
CONTACT US	801410 SNI10	SNI10	-	50	40	3,6	-
CONTACT US	801410 TNi20	TNi20	-	5	440	0,6	-
CONTACT US	801410 TNi20	TNi20	-	10	220	1,0	-
CONTACT US	801410 TNi20	TNi20	-	20	110	1,7	-
CONTACT US	801410 TNi20	TNi20	-	30	73	2,1	-
CONTACT US	801410 TNi20	TNi20	-	50	44	2,4	-
MADE TO ORDER	801410 TNi20	TNi20	-	5	440	0,416	-
MADE TO ORDER	801410 TNi20	TNi20	-	10	220	0,768	-
MADE TO ORDER	801410 TNi20	TNi20	-	20	110	1,7	-
MADE TO ORDER	801410 TNi20	TNi20	-	30	73	2	-
MADE TO ORDER	801410 TNi20	TNi20	-	50	44	2,7	-
CONTACT US	801410 TNi20	TNi20	-	5	400	0,5	-
CONTACT US	801410 TNi20	TNi20	-	10	200	1	-
CONTACT US	801410 TNi20	TNi20	-	20	100	2,3	-
CONTACT US	801410 TNi20	TNi20	-	30	67	2,6	-
CONTACT US	801410 TNi20	TNi20	-	50	40	3,6	-
CONTACT US	801415	-	yes	5	440	0,6	80
CONTACT US	801415	-	yes	10	220	1,0	70
CONTACT US	801415	-	yes	20	110	1,7	61

CONTACT US	801415	-	yes	30	73	2,1	49
CONTACT US	801415	-	yes	50	44	2,4	28
CONTACT US	801415	-	yes	5	440	0,416	
CONTACT US	801415	-	yes	10	220	0,768	
CONTACT US	801415	-	yes	20	110	1,7	
CONTACT US	801415	-	yes	30	73	2	
CONTACT US	801415	-	yes	50	44	2,7	
MADE TO ORDER	801415	-	yes	5	400	0,5	
MADE TO ORDER	801415	-	yes	10	200	1	
MADE TO ORDER	801415	-	yes	20	100	2,3	
MADE TO ORDER	801415	-	yes	30	67	2,6	
MADE TO ORDER	801415	-	yes	50	40	3,6	

General characteristics

Motor	80140004
Gearbox	81041
Nominal motor power at 24 V (W)	32
Max. torque (Nm)	10
Axial load dynamic (N)	10
Radial load dynamic (N)	15
Temperature rise at 50% cycle (°C)	45
Weight (g)	1500
Protection index	IP54

Dimension Diagram : 801410 with SNi10

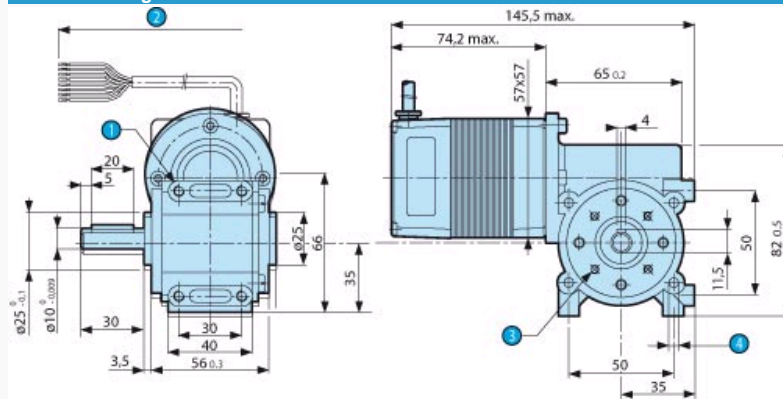

N° Legend

- | N° | Legend |
|----|--|
| 1 | 4 x M5 depth 8 mm (on rectangle 30x50) |
| 2 | Length of cable 400 ± 10 mm |
| 3 | 4 x M4 over Ø 36 depth 8 mm |
| 4 | 4 x M5 over depth 8 mm (on rectangle 30x50)
The left-hand and right-hand sides of the gearbox are identical |

Special adaptations

- Other powers (60 W - 95 W)
- Dimensions of gearbox shaft
- Without cable but with connector integrated in motor
- Cable length, with or without connector
- Other reduction ratios
- Mechanical holding brake

Precautions for use

The limits and precautions for use described in the 80140 brushless motor section must be observed.