

connector PowerTOP plus - Part no. 3403



- Screw terminals
- X-CONTACT
- cable gland with integrated strain relief and sealing
- housing with threat closing and push locking

Technical information

Ampere	63 A
Poles	3 P
Voltage	230 V
Earth position	6 h
Hertz	50/60 Hz
Connection technology	Screw terminals
Contact	X-CONTACT
Protection type	IP 67

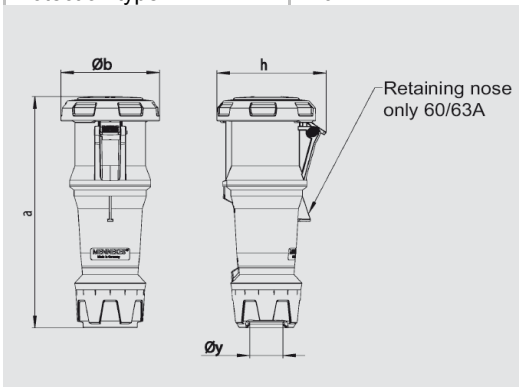

Drawing 3 MB 70	Amp. Poles	63			125		
		3	4	5	3	4	5
Dim. in mm	a	270	270	270	310	310	310
	Ø b	109	109	109	121	121	121
	h	121	121	121	133	133	133
	Ø y [max]	36	36	36	49	49	49
	Terminal for cond. cross	6	6	6	25	25	25
	section (mm ²) min.-max.	-16	-16	-16	-50	-50	-50