

PRELIMINARY SPEC

P/N: L-7701C4PBC-H



Technical Data



ATTENTION
OBSERVE PRECAUTIONS
FOR HANDLING
ELECTROSTATIC
DISCHARGE
SENSITIVE
DEVICES

Description

Static electricity and surge damage the LEDs. It is recommended to use a wrist band or anti-electrostatic glove when handling the LEDs. All devices, equipment and machinery must be electrically grounded.

Features

- * HIGH LUMINANCE OUTPUT.
- * DESIGN FOR HIGH CURRENT OPERATION.
- * SOLDERLESS MOUNTING TECHNIQUE.
- * LOW POWER CONSUMPTION.
- * LOW THERMAL RESISTANCE.
- * LOW PROFILE.
- * PACKAGED IN TUBES FOR USE WITH AUTOMATIC INSERTION EQUIPMENT.
- * RoHS COMPLIANT.

Benefits

- *Rugged Lighting Products.
- *Electricity savings.
- *Maintenance savings.
- *Environmental Conformance.

Typical Applications

- *Automotive Exterior Lighting.
- *Solid State Lighting and Signaling.

Outline Drawings

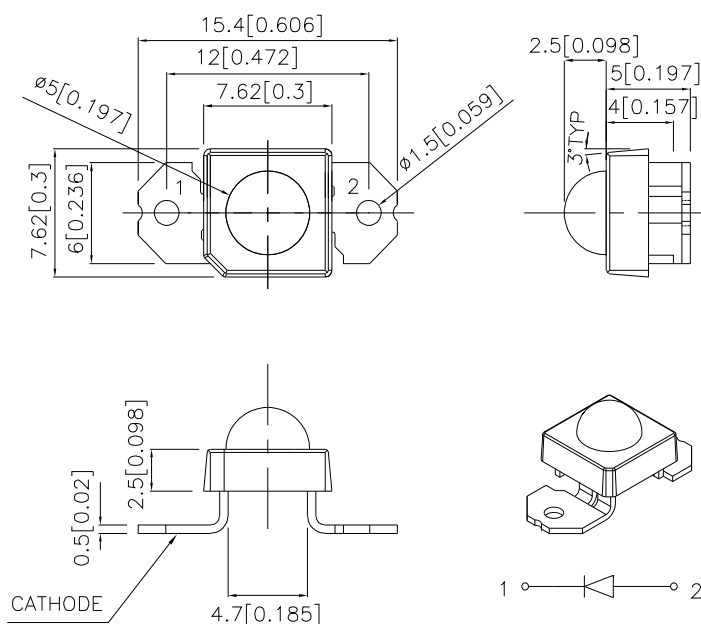

Notes:

1. All dimensions are in millimeters (inches).
2. Tolerance is ± 0.25 (0.01") unless otherwise noted.
3. Lead spacing is measured where the leads emerge from the package.
4. Specifications are subject to change without notice.

PATENT PENDING

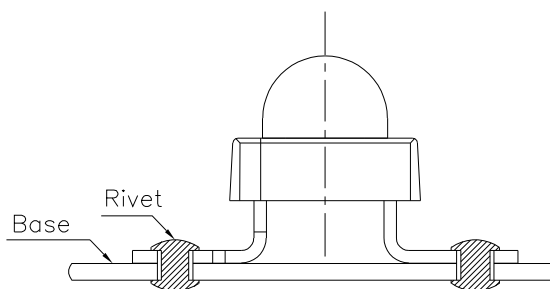

Absolute Maximum Ratings at $T_A=25^\circ\text{C}$

PARAMETER	PB-H	UNITS
DC Forward Current	50	mA
Power dissipation	235	mW
Reverse Voltage	5	V
Operating Temperature	-40 To +85	$^\circ\text{C}$
Storage Temperature	-55 To +85	$^\circ\text{C}$

Selection Guide

Part No.	LED COLOR	Iv(cd) ^[1] @50mA		Viewing Angle ^[2]
		MIN.	TYP.	2θ1/2 Typ.
L-7701C4PBC-H	BLUE (InGaN)	2.2	3.2	50°

Notes:

- 1.Luminous intensity is measured with an integrating sphere after the device has stabilized.
- 2.θ1/2 is the angle from optical centerline where the luminous intensity is 1/2 the optical centerline value.

Optical Characteristics at TA=25°C

IF=50mA Rθj-a=200°C/W

DEVICE TYPE	PEAK WAVELENGTH λPEAK (nm) TYP.	DOMINANT ^[1] WAVELENGTH λDOM (nm) TYP.	SPECTRAL LINE WAVELENGTH Δλ1/2(nm) TYP.
L-7701C4PBC-H	467	470	30

Note:

- 1.The dominant wavelength is derived from the CIE Chromaticity Diagram and represents the perceived color of the device.

Electrical Characteristics at TA=25°C

DEVICE TYPE	FORWARD VOLTAGE VF(VOLTS) @ IF=50mA			REVERSE CURRENT IR (uA) @ VR=5V	CAPACITANCE C (pF) @ VF=0V F=1MHZ	THERMAL RESISTANCE Rθj-pin °C/W
	MIN.	TYP.	MAX.	MAX.	TYP.	TYP.
	L-7701C4PBC-H	4.2	4.4	4.7	10	110

Figures

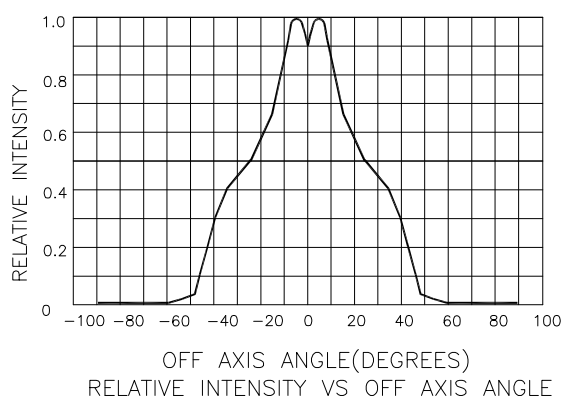
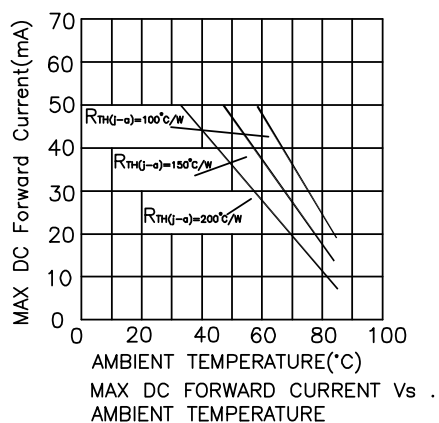
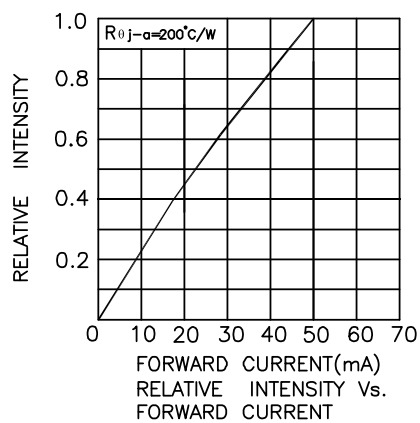
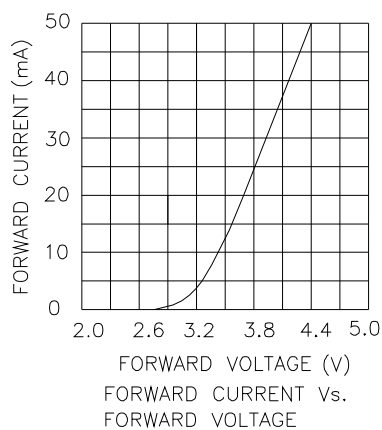
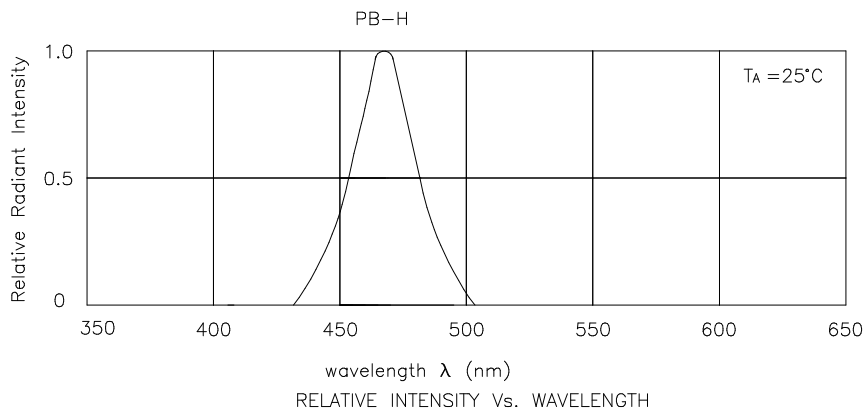

Remarks:

If special sorting is required (e.g. binning based on forward voltage, Luminous intensity/ luminous flux, or wavelength), the typical accuracy of the sorting process is as follows:

1. Wavelength: $\pm 1\text{nm}$
2. Luminous intensity/ luminous flux: $\pm 15\%$
3. Forward Voltage: $\pm 0.1\text{V}$

Note: Accuracy may depend on the sorting parameters.