



ENGLISH

Datasheet

DC Axial Fan, 60 x 60 x 15mm, 23.8m/h, 1.1W, 12 V dc (OD6015 Series)

RS Stock number [541-4921](#)



Frame and Impeller

PBT, UL94V-0 Thermoplastic

Available Options

Tachometer

Locked Rotor Alarm

Finger Guard: G60-4

Plastic Guard: G60P

Wire Mesh Guard: WMG60M

Filter Kit: GRM60-30, GRM60-45

RS Part Number	Orion Part Number	Speed (RPM)	Airflow (CFM)	Noise (db)	Volts (DC)	Voltage Range	Current (Amps)	Lead Type
5414959	OD6015-12HB	4500	16	33	12	6~13.8	0.13	Wire
5414937	OD6015-12MB	3900	14	28.8	12	6~13.8	0.11	Wire
5414921	OD6015-12LB	3500	12	27	12	6~13.8	0.09	Wire
5415205	OD6015-24HB	4500	16	33.3	24	12~28	0.09	Wire
5415198	OD6015-24MB	3900	14	30.7	24	12~28	0.07	Wire
5415182	OD6015-24LB	3500	12	27.2	24	12~28	0.05	Wire

Data Tolerance +/- 10%

RS, Professionally Approved Products, gives you professional quality parts across all products categories. Our range has been testified by engineers as giving comparable quality to that of the leading brands without paying a premium price.

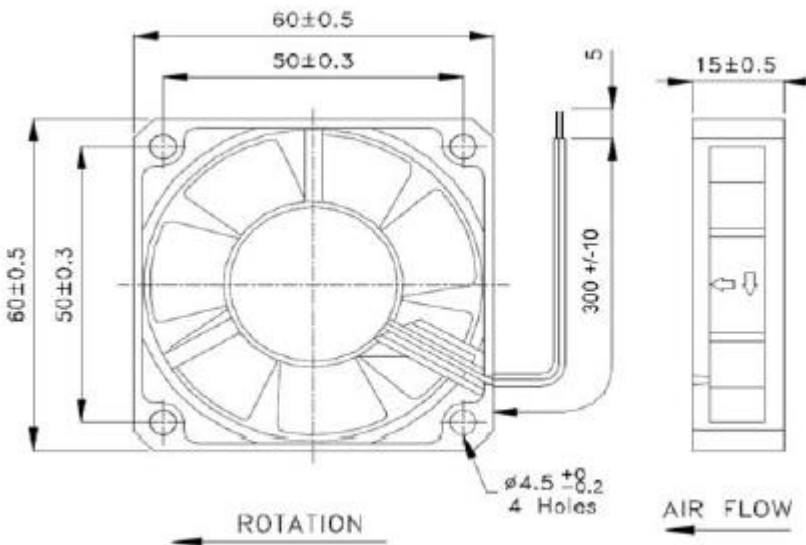
Drawing(mm):

*Drawing for Dimensional Reference Only

MOTOR

Brushless DC, polarity protected, locked rotor protected (current limited), auto restart

INSULATION RESISTANCE

Min. 10 M Ohms at 500VDC

LIFE EXPECTANCY (L10)

Ball Bearing 60,000 Hours

Operating Temperature

-10C ~ +70C

Safety Approvals

UL/CUL, TUV, CE