

Product Information



8477UFD125P62

EAN 4031582346985

Swivel castor with total lock, tail end of castor, housing made of Stainless Steel, double ball bearing swivel head, wheel axle with nut, plate fitting. Wheel centre made of Polyamide, Tread: elastic-tyre, non-marking, roller bearing, stainless

Technical Data

Wheel diameter	125 mm
Width of Tread	40 mm
Size of Plate	105 x 85 mm
Plate hole centres	80/77 x 60 mm
Plate hole	9 mm
Offset	40 mm
Swivel Interference	242 mm
Overall height	155 mm
Temperature	- 20 / + 80 °C
Standard	EN 12532
Weight	1.17 kg
Hardness of tread	A 64 Shore
Load capacity	250 kg
Load capacity (static)	500 kg

Roll performance	+	+	+	+	+
Movement noise	+	+	+	+	+
Attrition	+	+	+	+	+
Corrosion resistance	+	+	+	+	+

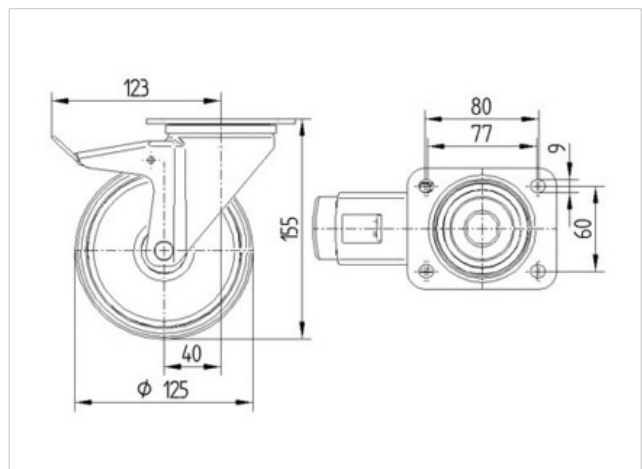

Product Information



8477UFD125P62

EAN 4031582346985

