



WAGO-I/O-SYSTEM 750
PROFINET IO advanced Fieldbus Coupler
750-375(/xxx-xxx)
2-port switch; 100 Mbit/s;
digital, analog and complex signals

Version 1.1.0



© 2014 by WAGO Kontakttechnik GmbH & Co. KG
All rights reserved.

WAGO Kontakttechnik GmbH & Co. KG

Hansastraße 27
D-32423 Minden

Phone: +49 (0) 571/8 87 – 0
Fax: +49 (0) 571/8 87 – 1 69

E-Mail: info@wago.com

Web: <http://www.wago.com>

Technical Support

Phone: +49 (0) 571/8 87 – 5 55
Fax: +49 (0) 571/8 87 – 85 55

E-Mail: support@wago.com

Every conceivable measure has been taken to ensure the accuracy and completeness of this documentation. However, as errors can never be fully excluded, we always appreciate any information or suggestions for improving the documentation.

E-Mail: documentation@wago.com

We wish to point out that the software and hardware terms as well as the trademarks of companies used and/or mentioned in the present manual are generally protected by trademark or patent.

Table of Contents

1	Notes about this Documentation.....	9
1.1	Validity of this Documentation.....	9
1.2	Copyright.....	9
1.3	Symbols.....	10
1.4	Number Notation.....	12
1.5	Font Conventions.....	12
1.6	Abbreviations and Terms.....	13
2	Important Notes.....	15
2.1	Legal Bases.....	15
2.1.1	Subject to Changes.....	15
2.1.2	Personnel Qualifications.....	15
2.1.3	Use of the 750 Series in Compliance with Underlying Provisions....	15
2.1.4	Technical Condition of Specified Devices.....	16
2.2	Safety Advice (Precautions).....	17
3	System Description.....	19
3.1	Manufacturing Number.....	20
3.2	Hardware Address (MAC ID).....	20
3.3	Component Update.....	22
3.4	Storage, Assembly and Transport.....	22
3.5	Assembly Guidelines/Standards.....	22
3.6	Power Supply.....	23
3.6.1	Isolation.....	23
3.6.2	System Supply.....	24
3.6.2.1	Connection.....	24
3.6.2.2	Dimensioning.....	25
3.6.3	Field Supply.....	28
3.6.3.1	Connection.....	28
3.6.3.2	Fusing.....	30
3.6.4	Supplementary Power Supply Regulations.....	33
3.6.5	Supply Example.....	34
3.6.6	Power Supply Unit.....	36
3.7	Grounding.....	37
3.7.1	Grounding the DIN Rail.....	37
3.7.1.1	Framework Assembly.....	37
3.7.1.2	Insulated Assembly.....	37
3.7.2	Grounding Function.....	38
3.8	Shielding.....	39
3.8.1	General.....	39
3.8.2	Bus cables.....	39
3.8.3	Signal lines.....	40
3.8.4	WAGO Shield Connecting System.....	40
4	Device Description.....	41
4.1	Fieldbus Coupler Properties.....	42
4.1.1	General Specifications.....	42
4.1.2	PROFINET IO Properties.....	43

4.1.3	Implemented Protocols and Services.....	44
4.1.4	Supported Profiles for PROFINET IO	44
4.2	View	45
4.3	Connectors.....	47
4.3.1	Device Supply	47
4.3.2	Fieldbus Connection.....	48
4.4	Display Elements	49
4.5	Operating Elements	51
4.5.1	Service Interface	51
4.5.2	DIP Switch.....	52
4.6	Technical Data	55
4.6.1	Device Data	55
4.6.2	System Data.....	56
4.6.3	Supply.....	56
4.6.4	Accessories	56
4.6.5	Connection Type	56
4.6.6	Climatic Environmental Conditions.....	57
4.7	Approvals	58
4.8	Standards and Guidelines	59
5	Mounting.....	60
5.1	Installation Position.....	60
5.2	Total Extension	60
5.3	Mounting onto Carrier Rail.....	62
5.3.1	Carrier Rail Properties	62
5.3.2	WAGO DIN Rail.....	63
5.4	Spacing.....	63
5.5	Mounting Sequence.....	64
5.6	Inserting and Removing Devices	65
5.6.1	Inserting the Fieldbus Coupler/Controller.....	66
5.6.2	Removing the Fieldbus Coupler/Controller	67
5.6.3	Inserting the I/O Module	68
5.6.4	Removing the I/O Module.....	69
6	Connect Devices	70
6.1	Data Contacts/Internal Bus	70
6.2	Power Contacts/Field Supply.....	71
6.3	Connecting a Conductor to the CAGE CLAMP®	72
7	Function Description	73
7.1	Device Start-Up and Initialization	73
7.2	Switch Port Settings	74
7.3	Identification and Maintenance Data Sets (I&M).....	75
7.4	Process Data Architecture	76
7.4.1	Basic Structure.....	76
7.4.1.1	Allocation of the Input and Output Data	77
7.4.2	Process Data Qualifiers in Telegrams for PROFINET IO	78
7.4.2.1	One Byte IOxS Process Data Qualifiers	78
7.4.2.2	Two Byte IOxS Process Data Qualifiers	78
7.4.2.3	Examples of One and Two Byte IOxS Process Data Qualifiers....	78
7.5	Configuration Limits.....	80

7.5.1	Minimum Configuration.....	80
7.5.2	Maximum Configuration	80
7.6	Flexible Configuration of Digital I/O Modules	80
7.6.1	Packaging Information from Digital Input and Output Modules	80
7.6.1.1	Rules for Packaging Digital Information.....	82
7.6.1.2	Example of Packaging Digital Information.....	83
7.6.1.3	Possible Errors when Packaging Digital Information	84
7.7	Variation of physical peripheral layout.....	84
7.7.1	Exemplary Maximum Configuration	85
7.7.1.1	Physical Option Modules.....	85
7.7.1.2	Virtual Option Modules	86
7.7.1.3	Combination of Physical and Virtual Option Modules	86
7.7.2	Station Characteristics using Option Modules	87
7.7.2.1	Connection Phase.....	87
7.7.2.2	Process Data Handling.....	88
7.7.2.3	Identification	88
7.7.2.4	I&M Data Sets	89
7.7.2.5	Diagnostics	89
7.8	I/O Module Distribution to Several ARs (Shared Device)	89
7.9	Using Fail-Safe I/O Modules (PROFIsafe V2).....	90
7.10	Individual Parameterization of I/O Modules via iPar Server.....	90
7.11	Controlling Digital and Analog Output Modules per PROFIenergy	92
7.11.1	Hardware	92
7.11.2	Functions	93
7.11.3	Addressing.....	93
7.12	Firmware Update.....	94
8	Commissioning	95
8.1	General Procedure	95
8.2	Procedure Description	96
8.3	Real Time Data Exchange Establishment.....	97
8.4	Perform configuration steps	97
8.5	GSD File.....	99
8.6	Parameterization.....	99
8.6.1	Parameterization of the Station Proxy (DAP)	99
8.6.1.1	Restart on K-Bus failure	100
8.6.1.2	Diagnostics of external module/channel errors	100
8.6.1.3	Internal data bus extension	100
8.6.1.4	Response to PROFINET IO failure	101
8.6.1.5	Response to K-Bus failure	101
8.6.1.6	Activation of the integrated Webserver	101
8.6.1.7	Activation of Firmware Updates	101
8.6.1.8	Activation of the station-wide PROFIenergy Functionality	102
8.6.2	Parameterization of the I/O-Modules	102
8.7	PROFINET Connection	103
8.7.1	Structure of the Application and Communication Relationships (AR and CR).....	103
8.7.1.1	Connection Response with no Configuration Differences	103
8.7.1.2	Connection Response with Configuration Differences	103
8.7.2	Parameterization of Submodule's Data Sets	104
8.7.3	End of the Parameterization Phase and Operational Readiness	104

8.8	Data Exchange	104
8.8.1	Send Cycle Times (Update Time)	104
8.8.2	Connection Monitoring	105
8.9	Demand Data Exchange (acyclic communication)	106
9	Web-based Management (WBM)	106
9.1	General Structure of WBM Pages	107
9.1.1	Status Area	108
9.2	Information	109
9.3	Ethernet	110
9.4	TCP/IP	111
9.5	Diagnostics	111
9.6	Administration	112
9.7	Connection Errors	113
10	Diagnostics	113
10.1	LED Signaling	114
10.1.1	Evaluating the Fieldbus Status	115
10.1.2	Evaluating the Node Status	117
10.1.3	Evaluating Power Supply Status	124
10.2	Error Response	124
10.2.1	Fieldbus Failure	124
10.2.2	Internal Data Bus Failure	125
10.3	PROFINET IO Diagnostics	125
10.3.1	Diagnosis Data Sets	126
10.3.2	Structure of the Standardized Diagnosis Data Sets	126
11	Fieldbus Communication	128
11.1	Standard ETHERNET Protocols	128
11.1.1	IP, TCP and HTTP	128
11.1.2	DCP	128
11.1.3	LLDP	129
11.1.4	MRP	129
11.1.5	SNMP	129
11.2	PROFINET IO	131
11.2.1	General	131
11.2.2	Cabling	132
11.2.3	PROFINET IO Device Classes	132
11.2.4	Addressing	133
11.2.5	PROFINET Communication Principle	134
11.2.5.1	Data Traffic	134
11.2.5.2	Communication Connection	134
11.2.5.3	Application and Communication Relationship (AR, CR)	135
11.2.6	System Start-Up	135
11.2.7	Data Exchange	136
11.2.8	Using Configuration Software	136
11.2.8.1	Hardware Configuration in the Configuration Software	136
11.2.8.2	Parameterization in the Configuration Software	136
11.2.8.3	Communication Configuration in the Configuration Software ...	136
12	I/O Modules	137

13	Use in Hazardous Environments	138
13.1	Marking Configuration Examples	139
13.1.1	Marking for Europe according to ATEX and IEC-Ex.....	139
13.1.2	Marking for America according to NEC 500	144
13.2	Installation Regulations.....	145
13.2.1	Special Conditions for Safe Use (ATEX Certificate TÜV 07 ATEX 554086 X).....	146
13.2.2	Special Conditions for Safe Use (ATEX Certificate TÜV 12 ATEX 106032 X).....	147
13.2.3	Special Conditions for Safe Use (IEC-Ex Certificate TUN 09.0001 X).....	148
13.2.4	Special Conditions for Safe Use (IEC-Ex Certificate IECEX TUN 12.0039 X).....	149
13.2.5	Special Conditions for Safe Use according to ANSI/ISA 12.12.01 ..	150
14	Appendix.....	151
14.1	Module and Submodule types of the I/O-Modules	151
14.1.1	Digital Input Modules.....	151
14.1.2	Digital Output Modules	155
14.1.3	Digital Input/Output Modules	159
14.1.4	Analog Input Modules.....	160
14.1.5	Analog Output Modules	162
14.1.6	Specialty Modules	163
14.1.6.1	Up/Down Counter.....	163
14.1.6.2	2-Channel Pulse Width Modules	164
14.1.6.3	Distance and Angle Measurement Modules	164
14.1.6.4	Serial Interfaces	165
14.1.6.5	DC-Drive Controller.....	166
14.1.6.6	RTC Module	166
14.1.6.7	DALI/DSI Master and DALI Multi-Master Modules	167
14.1.6.8	AS-Interface Master Modules.....	167
14.1.6.9	RF Modules	168
14.1.6.10	MP-Bus Master Modules	169
14.1.6.11	Vibration Monitoring.....	169
14.1.6.12	Safety Modules PROFIsafe V2	170
14.1.6.13	Stepper Modules	170
14.1.6.14	I/O-Link Master (from FW 03).....	171
14.1.6.15	CAN Gateway (from FW 03)	171
14.1.6.16	Proportional Valve Module (from FW 03).....	171
14.1.7	System Modules	172
14.1.7.1	Power Supply Modules.....	172
14.2	Parameters of the I/O Modules	172
14.2.1	Digital Input Modules (DI).....	172
14.2.2	Digital Output Modules (DO)	174
14.2.3	Digital Output Modules with Diagnostics (DO, DIA)	175
14.2.4	PROFIenergy Submodules (DO, PE).....	176
14.2.5	Analog Input Modules.....	177
14.2.6	Special AI Module Types (AI, RTD, TC).....	179
14.2.7	Analog Output Module (AO)	187
14.2.8	Analog Output Module with Diagnostics (AO, DIA)	188
14.2.9	Special AO Module Types with Parameter Channel (AO, 562, 563).....	189

14.2.10	PROFIenergy Submodules (AO, PE).....	191
14.2.11	Specialty Modules	192
14.2.12	System Modules	196
14.3	Record Data Sets	198
14.4	Detailed structures I&M 0-4	200
14.5	Structure of the Standardized Diagnosis Data Sets.....	202
14.5.1	Extended Channel Diagnostics.....	202
14.5.1.1	1.3.1.1 Fault Cases of I/O Modules with Diagnostics Capability	207
14.5.1.1.1	Digital Input Modules	207
14.5.1.1.2	Digital Output Modules	207
14.5.1.1.3	Analog Input Modules	208
14.5.1.1.4	Analog Output Modules.....	209
14.5.1.1.5	Complex I/O Modules.....	210
14.5.1.1.6	PROFIsafe V2 iPar I/O Modules	211
14.5.2	Difference between Real and Expected Configuration	211
List of Figures		215
List of Tables.....		217

1 Notes about this Documentation

Note



Keep this documentation!

The operating instructions are part of the product and shall be kept for the entire lifetime of the device. They shall be transferred to each subsequent owner or user of the device. Care must also be taken to ensure that any supplement to these instructions are included, if applicable.

1.1 Validity of this Documentation

This documentation is only applicable to the fieldbus controller 750-375 (PROFINET IO advanced Fieldbus Coupler) and the variants listed in the table below.

Tabelle 1: Variations

Oder number/ Variation	Designation
750-375	Fieldbus coupler PROFINET IO advanced
750-375/025-000	/T (Extended operating temperature range: -20 °C ... +60 °C)

The product PROFINET IO advanced Fieldbus Coupler 750-375 shall only be installed and operated according to the instructions in this manual and the system description for the WAGO-I/O-SYSTEM 750.

NOTICE

Consider power layout of the WAGO-I/O-SYSTEM 750!

In addition to these operating instructions, you will also need the system description for the WAGO-I/O-SYSTEM 750, which can be downloaded at www.wago.com. There, you can obtain important information including information on electrical isolation, system power and supply specifications.

1.2 Copyright

This Manual, including all figures and illustrations, is copyright-protected. Any further use of this Manual by third parties that violate pertinent copyright provisions is prohibited. Reproduction, translation, electronic and phototechnical filing/archiving (e.g., photocopying) as well as any amendments require the written consent of WAGO Kontakttechnik GmbH & Co. KG, Minden, Germany. Non-observance will involve the right to assert damage claims.

1.3 Symbols

DANGER

Personal Injury!

Indicates a high-risk, imminently hazardous situation which, if not avoided, will result in death or serious injury.

DANGER



Personal Injury Caused by Electric Current!

Indicates a high-risk, imminently hazardous situation which, if not avoided, will result in death or serious injury.

WARNING

Personal Injury!

Indicates a moderate-risk, potentially hazardous situation which, if not avoided, could result in death or serious injury.

CAUTION

Personal Injury!

Indicates a low-risk, potentially hazardous situation which, if not avoided, may result in minor or moderate injury.

NOTICE

Damage to Property!

Indicates a potentially hazardous situation which, if not avoided, may result in damage to property.

NOTICE



Damage to Property Caused by Electrostatic Discharge (ESD)!

Indicates a potentially hazardous situation which, if not avoided, may result in damage to property.

Note



Important Note!

Indicates a potential malfunction which, if not avoided, however, will not result in damage to property.



Information

Additional Information:

Refers to additional information which is not an integral part of this documentation (e.g., the Internet).

1.4 Number Notation

Table 2: Number notation

Number code	Example	Note
Decimal	100	Normal notation
Hexadecimal	0x64	C notation
Binary	'100' '0110.0100'	In quotation marks, nibble separated with dots (.)

1.5 Font Conventions

Table 3: Font conventions

Font type	Indicates
<i>italic</i>	Names of paths and data files are marked in italic-type. e.g.: <i>C:\Programme\WAGO-I/O-CHECK</i>
Menu	Menu items are marked in bold letters. e.g.: Save
>	A greater-than sign between two names means the selection of a menu item from a menu. e.g.: File > New
Input	Designation of input or optional fields are marked in bold letters, e.g.: Start of measurement range
“Value”	Input or selective values are marked in inverted commas. e.g.: Enter the value “4 mA” under Start of measurement range .
[Button]	Pushbuttons in dialog boxes are marked with bold letters in square brackets. e.g.: [Input]
[Key]	Keys are marked with bold letters in square brackets. e.g.: [F5]

1.6 Abbreviations and Terms

Table 4: Abbreviations and terms used in this manual

Abbreviation/ Term	Explanation	Description
AIDA	Automation Initiative of German Automotive Manufacturers	Association of german automotive manufacturers using generally PROFINET IO in production plants.
ALCR	Alarm CR	Acyclic PROFINET IO real-time channel for transmission of alarm messages.
API	Application Process Identifier	Addressing level in addition to the slots and subslots. This addressing level allows you to handle different applications individually to prevent overlap of data storage areas (slots and subslots) and concurrent access.
AR	Application Relationship	Application relationship between IOC or IOS and IOD.
CAT5	Category 5	Cable category 5 according to EIA/TIA-568.
CCx	Communication channels for parameterization	Communication channels according to TCI-conformance classes: CC1: Conformance Class 1 via local configuration interface CC2: Conformance Class 2 via TCP/IP using Service-Port 6626 CC3: Conformance Class 1 via PROFINET IO supervisor connection
CPD	Configuration, Parameterization and Diagnostic	Configuration, parameterization and diagnostic (CPD) tools simplify navigation and communication with fail-safe PROFIsafe I/O modules for setting individual safety-related parameters.
CR	Communication Relationship	Communication relationship between IOC or IOS and IOD.
DAP	Device Access Point (DAP)	Station proxy, network access point, a DAP represents the fieldbus interface and determines the essential properties of the IO device.
DCP	Discovery and basic Configuration Protocol	PROFINET protocol used to set station names, IP settings and other parameters.
DIP	Dual in Line Package	The DIP switch is comprised of a series of eight individual shift switches.
GSD	General Station Description	Device description for configuring IO devices within the engineering system.
GSDML	General Station Description Markup Language	An XML-based language, GSDML is used as the language for the device description file.
HTTP	HyperText Transmission Protocol	Data exchange protocol used for transmission of internet data, e.g. transfer of websites. Web browsers communicate to web servers via this protocol.
IOC	IO Controller	Master in the PROFINET IO network.
IOCR	Input/Output CR	Describes the connection for the PROFINET IO real-time channel in the input and output direction.
IOD	IO Device	Slave in the PROFINET IO network (here the fieldbus node or station, sometimes also used for the fieldbus coupler as a station proxy à "DAP").

Table 4: Abbreviations and terms used in this manual

Abbreviation/ Term	Explanation	Description
IOS	IO Supervisor	Programming device in the PROFINET IO network.
IOX	IO station	Station in the PROFINET IO network, "X" stands for "Device", "Controller" or "Supervisor".
iPar	iParameter	Individual parameterization of safety-related parameters for fail-safe PROFIsafe V2 I/O modules. The standardized Individual Parameter Server (iPar Server) automatically restores the parameterization when replacing components.
IPv4	Internet Protocol Version 4	IPv4 describes the 4th version of IP protocol which is used in internet to route network packets to its destination. Version 4 was specified in RFC 791 in 1981.
K-Bus	Internal bus	Internal communication system (local bus) of series 750/753.
LED	Light Emitting Diode	Indicator light signaling device states.
LLDP	Link Layer Discovery Protocol	According to IEC, standardized Layer 2 protocol that provides the basis for PROFINET topology detection.
MCR	Multicast CR	Multicast Communication Relationship, exchange of productive data with no intervention of an IO controller or IO supervisor.
MIB	Management Information Base	Database of certain protocols, e.g. LLDP that can be read via SNMP.
Module, module type	Module, module type	Respective data set in the configuration tool for various I/O modules, types.
NIL	Not In List	The entry is not in the list.
PE	PROFIenergy	Energy management profile based on the communication mechanisms of PROFINET IO.
PNIO	PROFINET IO	Abbreviation for PROFINET IO.
RDCR	Record Data CR	Acyclic reading and writing of data sets.
RTA Alarm	"Real-Time Protocol Acyclic" Alarm	Acyclic real-time alarm transfer between IO controller and IO device.
SEDI	WAGO-Safety-Editor 75x	WAGO tooling for individual parameterization of PROFIsafe V2 I/O modules.
SNMP V1/V2	Simple Network Management Protocol Version 1/ Version 2	Standard protocol according to IEC used for the management of ETHERNET devices in version 1 and 2.
Submodule, submodule type	Submodule, submodule type	Respective selectable data set in the configuration tool for various process data assignment options of the I/O modules, types.
TCI	Tool Calling Interface	Open interface for integrating device tools in engineering systems.
TCP	Transmission Control Protocol	Protocol for data transmission.
WBM	Web-based Management	HTTP-based management unit for configuration and information purposes for ETHERNET devices.

2 Important Notes

This section includes an overall summary of the most important safety requirements and notes that are mentioned in each individual section. To protect your health and prevent damage to devices as well, it is imperative to read and carefully follow the safety guidelines.

2.1 Legal Bases

2.1.1 Subject to Changes

WAGO Kontakttechnik GmbH & Co. KG reserves the right to provide for any alterations or modifications that serve to increase the efficiency of technical progress. WAGO Kontakttechnik GmbH & Co. KG owns all rights arising from the granting of patents or from the legal protection of utility patents. Third-party products are always mentioned without any reference to patent rights. Thus, the existence of such rights cannot be excluded.

2.1.2 Personnel Qualifications

All sequences implemented on Series 750 devices may only be carried out by electrical specialists with sufficient knowledge in automation. The specialists must be familiar with the current norms and guidelines for the devices and automated environments.

All changes to the coupler or controller should always be carried out by qualified personnel with sufficient skills in PLC programming.

2.1.3 Use of the 750 Series in Compliance with Underlying Provisions

Fieldbus couplers, fieldbus controllers and I/O modules found in the modular WAGO-I/O-SYSTEM 750 receive digital and analog signals from sensors and transmit them to actuators or higher-level control systems. Using programmable controllers, the signals can also be (pre-) processed.

The components have been developed for use in an environment that meets the IP20 protection class criteria. Protection against finger injury and solid impurities up to 12.5 mm diameter is assured; protection against water damage is not ensured. Unless otherwise specified, operation of the components in wet and dusty environments is prohibited.

Operating 750 Series components in home applications without further measures is only permitted if they meet the emission limits (emissions of interference) according to EN 61000-6-3. You will find the relevant information in the section on “WAGO-I/O-SYSTEM 750” → “System Description” → “Technical Data” in the manual for the used fieldbus coupler/controller.

Appropriate housing (per 94/9/EG) is required when operating the WAGO-I/O-SYSTEM 750 in hazardous environments. Please note that a prototype test certificate must be obtained that confirms the correct installation of the system in a housing or switch cabinet.

2.1.4 Technical Condition of Specified Devices

The devices to be supplied ex works are equipped with hardware and software configurations, which meet the individual application requirements. WAGO Kontakttechnik GmbH & Co. KG will be exempted from any liability in case of changes in hardware or software as well as to non-compliant usage of devices.

Please send your request for modified and new hardware or software configurations directly to WAGO Kontakttechnik GmbH & Co. KG.

2.2 Safety Advice (Precautions)

For installing and operating purposes of the relevant device to your system the following safety precautions shall be observed:



DANGER

Do not work on devices while energized!

All power sources to the device shall be switched off prior to performing any installation, repair or maintenance work.

DANGER

Installation only in appropriate housings, cabinets or in electrical operation rooms!

The WAGO-I/O-SYSTEM 750 and its components are an open system. As such, install the system and its components exclusively in appropriate housings, cabinets or in electrical operation rooms. Allow access to such equipment and fixtures to authorized, qualified staff only by means of specific keys or tools.

NOTICE

Replace defective or damaged devices!

Replace defective or damaged device/module (e.g., in the event of deformed contacts), since the long-term functionality of device/module involved can no longer be ensured.

NOTICE

Protect the components against materials having seeping and insulating properties!

The components are not resistant to materials having seeping and insulating properties such as: aerosols, silicones and triglycerides (found in some hand creams). If you cannot exclude that such materials will appear in the component environment, then install the components in an enclosure being resistant to the above-mentioned materials. Clean tools and materials are imperative for handling devices/modules.

NOTICE

Cleaning only with permitted materials!

Clean soiled contacts using oil-free compressed air or with ethyl alcohol and leather cloths.

NOTICE**Do not use any contact spray!**

Do not use any contact spray. The spray may impair contact area functionality in connection with contamination.

NOTICE**Do not reverse the polarity of connection lines!**

Avoid reverse polarity of data and power supply lines, as this may damage the devices involved.

NOTICE**Avoid electrostatic discharge!**

The devices are equipped with electronic components that you may destroy by electrostatic discharge when you touch. Pay attention while handling the devices to good grounding of the environment (persons, job and packing).

3 System Description

The WAGO-I/O-SYSTEM 750 is a modular, fieldbus-independent input/output system (I/O system). The configuration described here consists of a fieldbus coupler/controller (1) and the modular I/O modules (2) for any signal shapes that form the fieldbus node together. The end module (3) completes the node and is required for correct operation of the fieldbus node.

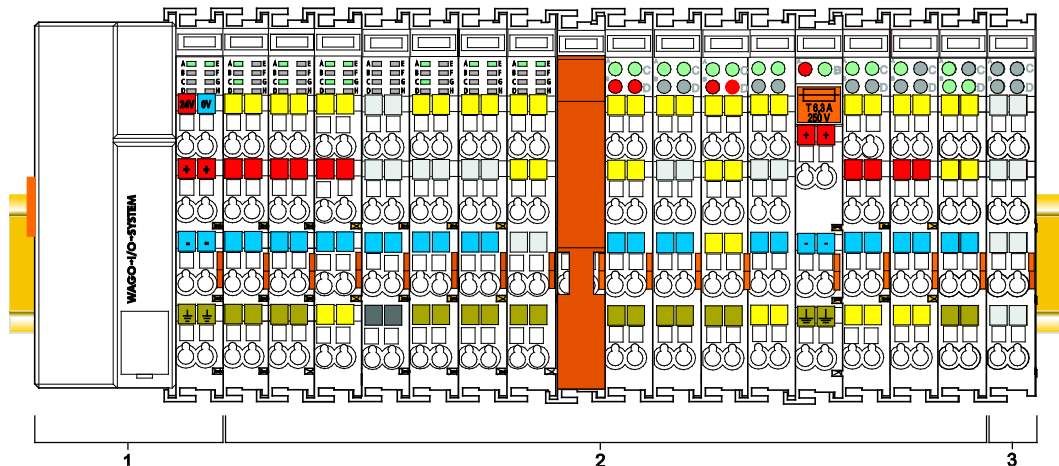

Figure 1: Fieldbus node (example)

Fieldbus couplers/controllers are available for different fieldbus systems.

The extended ECO fieldbus couplers contain the fieldbus interface, electronics and a power supply terminal. The fieldbus interface forms the physical interface to the relevant fieldbus. The electronics process the data of the bus modules and make it available for the fieldbus communication. The 24 V system supply and the 24 V field supply are fed in via the integrated power supply terminal.

The fieldbus coupler/controller communicates via the relevant fieldbus. The programmable fieldbus controller (PFC) enables the implementation of additional PLC functions. Programming is done with the WAGO-I/O-PRO in accordance with IEC 61131-3.

I/O modules for diverse digital and analog I/O signals as well as special functions can be connected to the fieldbus coupler/controller. The communication between the fieldbus coupler/controller and the I/O modules is carried out via an internal bus.

The WAGO-I/O-SYSTEM 750 has a clear port level with LEDs for status indication, insertable mini WSB markers and group marker carriers for marking.

The 1, 2 or 3 wire technology supplemented by a ground wire connection allows for direct sensor or actuator wiring.

3.1 Manufacturing Number

The serial number indicates the delivery status directly after production. This number is part of the labeling on the side of each component. In addition, the serial number is printed on the cover cap of the configuration and programming interface of the fieldbus coupler/controller, so that it can also be read when installed.

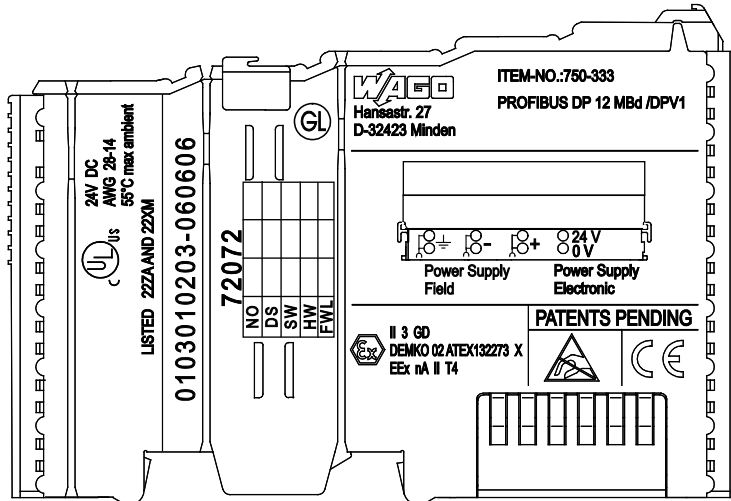

Figure 2: Labeling on the side of a component (example)

Manufacturing number					
01	03	01	02	03	-B060606
Calendar week	Year	Software version	Hardware version	Firmware loader version	Internal number

Figure 3: Example of a manufacturing number

The manufacturing number consists of the production week and year, the software version (if available), the hardware version of the component, the firmware loader (if available) and further internal information for WAGO Kontakttechnik GmbH & Co. KG.

3.2 Hardware Address (MAC ID)

Each PROFINET IO advanced Fieldbus Coupler has an internationally unambiguous physical address, referred to as the MAC-ID (Media Access Control Identity).

As part of the labeling on the right side of this component, the MAC ID is printed in the block diagram of the fieldbus coupler/controller.

In addition, the MAC ID is located on a self-adhesive tear-off label on the left side of the fieldbus coupler/controller.

The MAC ID has a fixed length of 6 bytes (48 bits) which are presented hexadecimal. The first three bytes identify the manufacturer (e.g. 00:30 DE for WAGO). The second 3 bytes comprise the unique serial number of the hardware.

This MAC ID is the physical device MAC address for the interface.
In addition, each switch port of the fieldbus coupler has its own MAC address.

The MAC address of the switch ports can be determined by adding port instance to the interface MAC.

The MAC ID for port 1 is defined by adding "1", the MAC ID of port 2 is obtained by adding "2" to the serial number of the interface MAC ID.

Example:

If the interface MAC ID ends to "FE", then the following port MAC IDs arise:

MAC ID of Interface:	"00 : 30 : DE : 01 : FF :FE"
MAC ID of port 1:	"00 : 30 : DE : 01 : FF :FF"
MAC ID of port 2:	"00 : 30 : DE : 02 : 00 :00"

The port MAC IDs are used by LLDP and MRP telegrams.

3.3 Component Update

For the case of an update of one component, the lateral marking on each component contains a prepared matrix.

This matrix makes columns available for altogether three updates to the entry of the current update data, like production order number (NO; starting from calendar week 13/2004), date stamp (DS), software version (SW), hardware version (HW) and the firmware loader version (FWL, if available).

Current Version data for		1. Update	2. Update	3. Update	
Production Order Number	NO				← only starting from calendar week 13/2004
Date stamp	DS				
Software index	SW				
Hardware index	HW				← only for fieldbus coupler/controller
Firmware loader index	FWL				

If the update of a component took place, the current version data are registered into the columns of the matrix.

Additionally with the update of a fieldbus coupler or controller also the cover of the configuration and programming interface of the fieldbus coupler or controller is imprinted with the current production order number.

The original manufacturing data on the housing of the component remain thereby.

3.4 Storage, Assembly and Transport

Whenever possible, the components are to be stored in their original packaging. Likewise, the original packaging provides optimal protection during transport.

When assembling or repacking the components, the contacts must not be soiled or damaged. The components must be stored and transported in appropriate containers/packaging. Thereby, the ESD information is to be regarded.

3.5 Assembly Guidelines/Standards

DIN 60204	Electrical equipping of machines
DIN EN 50178	Equipping of high-voltage systems with electronic components (replacement for VDE 0160)
EN 60439	Low voltage switchgear assemblies

3.6.2 System Supply

3.6.2.1 Connection

The WAGO-I/O-SYSTEM 750 requires a 24 V direct current system supply. The power supply is provided via the fieldbus coupler/controller and, if necessary, in addition via the internal system supply modules. The power supply is reverse voltage protected.

NOTICE

Do not use an incorrect voltage/frequency!

The use of an incorrect supply voltage or frequency can cause severe damage to the component.

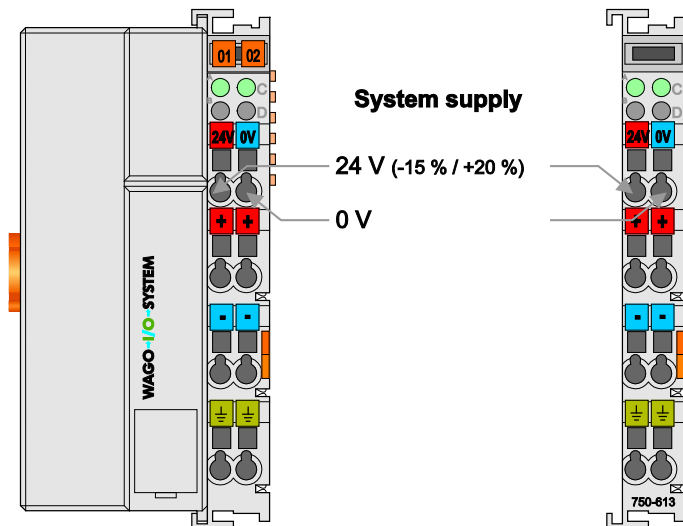

Figure 5: System supply for standard fieldbus coupler/controller and extended ECO couplers

The fed DC 24 V supplies all internal system components, e.g. fieldbus coupler/controller electronics, fieldbus interface and I/O modules via the internal bus (5 V system voltage). The 5 V system voltage is galvanically connected to the 24 V system supply.

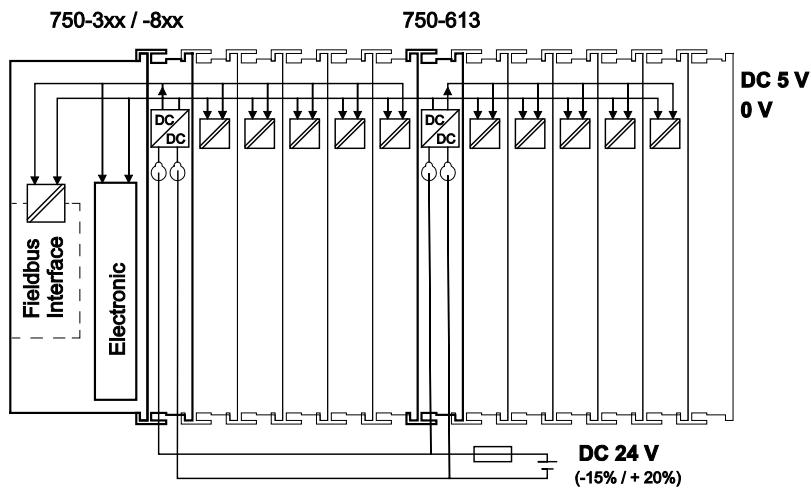

Figure 6: System voltage for standard couplers/controllers and extended ECO couplers

Note



Only reset the system simultaneously for all supply modules!

Reset the system by simultaneously switching the system supply at all supply modules (fieldbus coupler/controller and potential supply module with bus power supply) off and on again.

3.6.2.2 Dimensioning

Note



Recommendation

A stable power supply cannot always be assumed. Therefore, you should use regulated power supplies to ensure the quality of the supply voltage.

The supply capacity of the fieldbus coupler/controller or the internal system supply module can be taken from the technical data of the components.

Table 5: Alignment

Internal current consumption^{*)}	Current consumption via system voltage (5 V for electronics of I/O modules and fieldbus coupler/controller).
Total current for I/O modules^{*)}	Available current for the I/O modules. Provided by the bus power supply unit. See fieldbus coupler/controller and internal system supply module

^{*)} See current catalog, manuals, Internet

Example:**Calculating the current consumption on an Example Coupler:**

Internal current consumption	380 mA at 5 V
Residual current for bus modules	1620 mA at 5 V
Sum $I_{(5\text{ V})}$ total	2000 mA at 5V

The internal current consumption is indicated in the technical data for each bus terminal. In order to determine the total requirement, add together the values of all I/O modules in the node.

Note**Observe total current of I/O modules, re-feed the potential if required!**

If the sum of the I/O modules' internal current consumption exceeds the residual current for I/O modules, then an internal system supply module must be placed before the module where the permissible residual current was exceeded.

Example:**Calculating the total current on the Example Coupler described above:**

A node with the example coupler, which is described above, consists of: 20 relay modules (750-517) and 10 digital input modules (750-405).

Internal current consumption	$20 * 90 \text{ mA} = 1800 \text{ mA}$
	$10 * 2 \text{ mA} = 20 \text{ mA}$
Sum	1820 mA

The example coupler can provide 1620 mA (see previous example) for the bus modules. This value is given in the associated data sheet. Consequently, an internal system supply module (750-613), e. g. in the middle of the node, should be added.

Note**Recommendation**

Utilize the **smartDESIGNER** feature WAGO ProServe[®] software to configure fieldbus node assembly. You can test the configuration via the integrated plausibility check.

The maximum input current of the 24 V system supply is 500 mA. The exact electrical consumption ($I_{(V)}$) can be determined with the following formulas:

Fieldbus coupler or controller

$I_{(5\text{ V})\text{ total}}$ = Sum of all the internal current consumption of the connected I/O modules + internal current consumption of the fieldbus coupler/controller

Internal system supply module

$I_{(5\text{ V})\text{ total}}$ = Sum of all the internal current consumption of the connected I/O modules at internal system supply module

$$\text{Input current } I_{(24\text{ V})} = \frac{5\text{ V}}{24\text{ V}} * \frac{I_{(5\text{ V})\text{ total}}}{\eta}$$

$$\eta = 0.87$$

(87 % Efficiency of the power supply at nominal load 24 V)



Note

Activate all outputs when testing the current consumption!

If the electrical consumption of a power supply point for the 24 V system supply exceeds 500 mA, then the cause may be an improperly dimensioned node or a defect.

During the test, you must activate all outputs.

3.6.3 Field Supply

3.6.3.1 Connection

Sensors and actuators can be directly connected to the relevant channel of the I/O module in 1, 2, 3 or 4 conductor connection technology. The I/O module supplies power to the sensors and actuators. The input and output drivers of some I/O modules require the field side supply voltage.

The fieldbus coupler/controller provides field side power (DC 24 V). In this case it is a passive power supply without protection equipment.

Power supply modules with or without fuse holder and diagnostic capability are available for the power supply of other field potentials (DC 24 V, AC/DC 0 ... 230 V, AC 120 V, AC 230 V). The power supply modules can also be used to set up various potential groups. The connections are connected in pairs to a power contact.

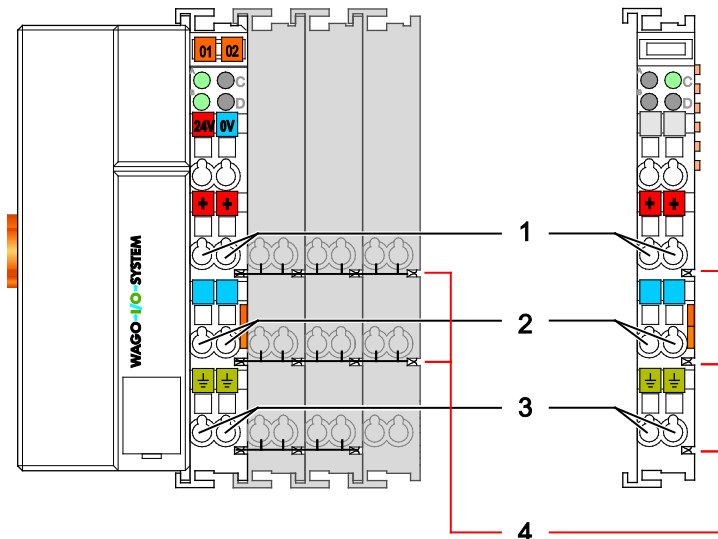

Figure 7: Field supply for standard couplers/controllers and extended ECO couplers

Table 6: Caption for “Field supply (sensor/actuator) for standard couplers/controllers and extended ECO couplers”

Field supply	
1	24 V (-15 % / +20 %)
2	0 V
3	Optional ground potential
Power jumper contacts	
4	Potential distribution to adjacent I/O modules

The supply voltage for the field side is automatically passed to the next module via the power jumper contacts when assembling the I/O modules.

The current load of the power contacts must not exceed 10 A on a continual basis.

By inserting an additional power supply module, the field supply via the power contacts is disrupted. From there a new power supply occurs which may also contain a new voltage potential.

Note



Re-establish the ground connection when the connection to the power jumper contacts is disrupted!

Some I/O modules have no or very few power contacts (depending on the I/O function). Due to this, the passing through of the relevant potential is disrupted. If you require a field supply via power jumper contacts for subsequent I/O modules, then you have to use a power supply module.

Note the data sheets of the I/O modules.

Note



Use a spacer module when setting up a node with different potentials!

In the case of a node setup with different potentials, e.g. the alteration from DC 24 V to AC 230 V, you should use a spacer module. The optical separation of the potentials acts as a warning to heed caution in the case of wiring and maintenance works. Thus, you can prevent the results of wiring errors.

3.6.3.2 Fusing

Internal fusing of the field supply is possible for various field voltages via an appropriate power supply module.

Table 7: Power supply modules

Order No.	Field Voltage
750-601	24 V DC, Supply/Fuse
750-609	230 V AC, Supply/Fuse
750-615	120 V AC, Supply/Fuse
750-617	24 V AC, Supply/Fuse
750-610	24 V DC, Supply/Fuse/Diagnosis
750-611	230 V AC, Supply/Fuse/Diagnosis
750-606	Supply Module 24 V DC, 1,0 A, Ex i
750-625/000-001	Supply Module 24 V DC, 1,0 A, Ex i (without diagnostics)

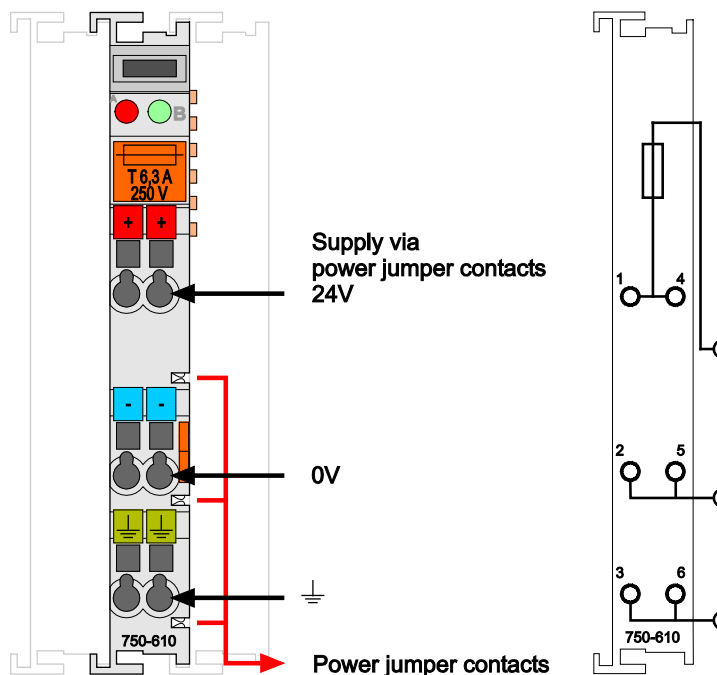

Figure 8: Supply module with fuse carrier (Example 750-610)

NOTICE

Observe the maximum power dissipation and, if required, UL requirements!

In the case of power supply modules with fuse holders, you must only use fuses with a maximum dissipation of 1.6 W (IEC 127).

For UL approved systems only use UL approved fuses.

In order to insert or change a fuse, or to switch off the voltage in succeeding I/O modules, the fuse holder may be pulled out. In order to do this, use a screwdriver for example, to reach into one of the slits (one on both sides) and pull out the holder.



Figure 9: Removing the fuse carrier

Lifting the cover to the side opens the fuse carrier.



Figure 10: Opening the fuse carrier



Figure 11: Change fuse

After changing the fuse, the fuse carrier is pushed back into its original position.

Alternatively, fusing can be done externally. The fuse modules of the WAGO series 281 and 282 are suitable for this purpose.

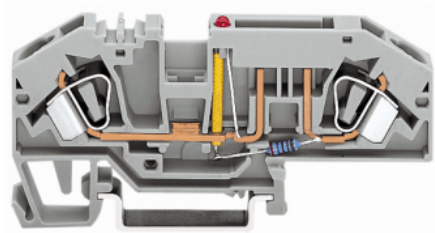

Figure 12: Fuse modules for automotive fuses, series 282

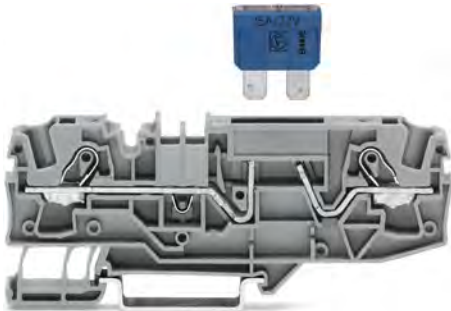

Figure 13: Fuse modules for automotive fuses, series 2006

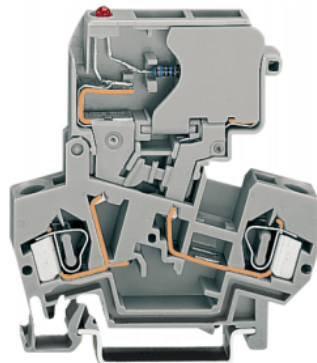

Figure 14: Fuse modules with pivotable fuse carrier, series 281

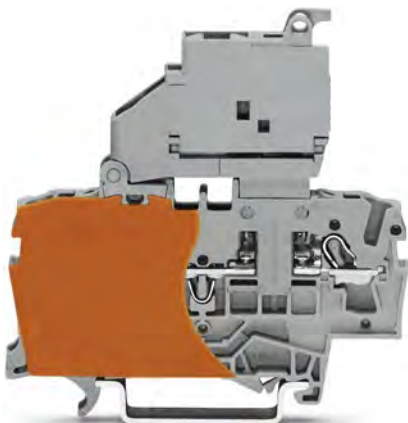

Figure 15: Fuse modules with pivotable fuse carrier, series 2002

3.6.4 Supplementary Power Supply Regulations

The WAGO-I/O-SYSTEM 750 can also be used in shipbuilding or offshore and onshore areas of work (e. g. working platforms, loading plants). This is demonstrated by complying with the standards of influential classification companies such as Germanischer Lloyd and Lloyds Register.

Filter modules for 24 V supply are required for the certified operation of the system.

Table 8: Filter modules for 24 V supply

Order No.	Name	Description
750-626	Supply Filter	Filter module for system supply and field supply (24 V, 0 V), i. e. for fieldbus coupler/controller and bus power supply (750-613)
750-624	Supply Filter	Filter module for the 24 V field supply (750-602, 750-601, 750-610)

Therefore, the following power supply concept must be absolutely complied with.

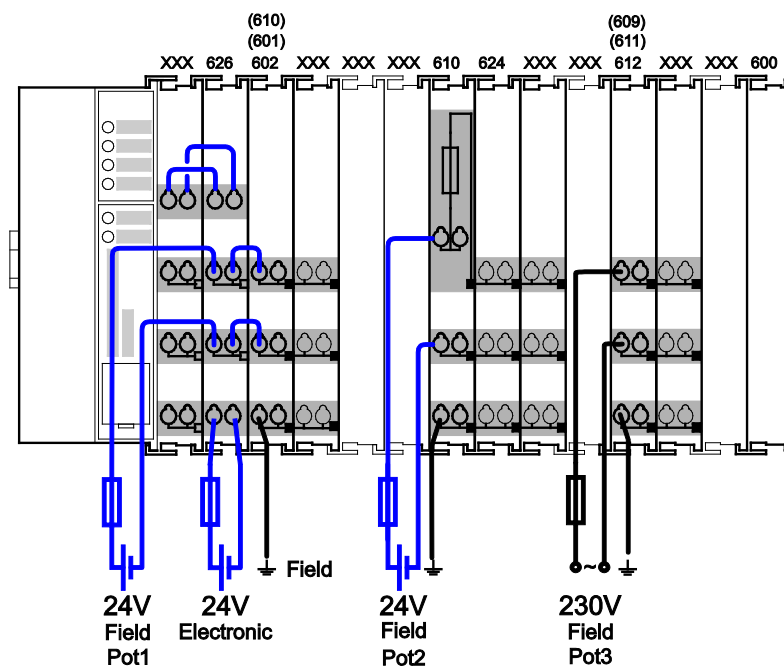

Figure 16: Power supply concept

Note



Additional supply module for potential equalization!

Only insert another potential power terminal 750-601/602/610 behind the filter terminal 750-626 if you need the lower power contact for potential equalization, for example, between the shield connections and you need an extra tap for this potential.

3.6.5 Supply Example

Note



The system supply and the field supply shall be separated!

You should separate the system supply and the field supply in order to ensure bus operation in the event of a short-circuit on the actuator side.

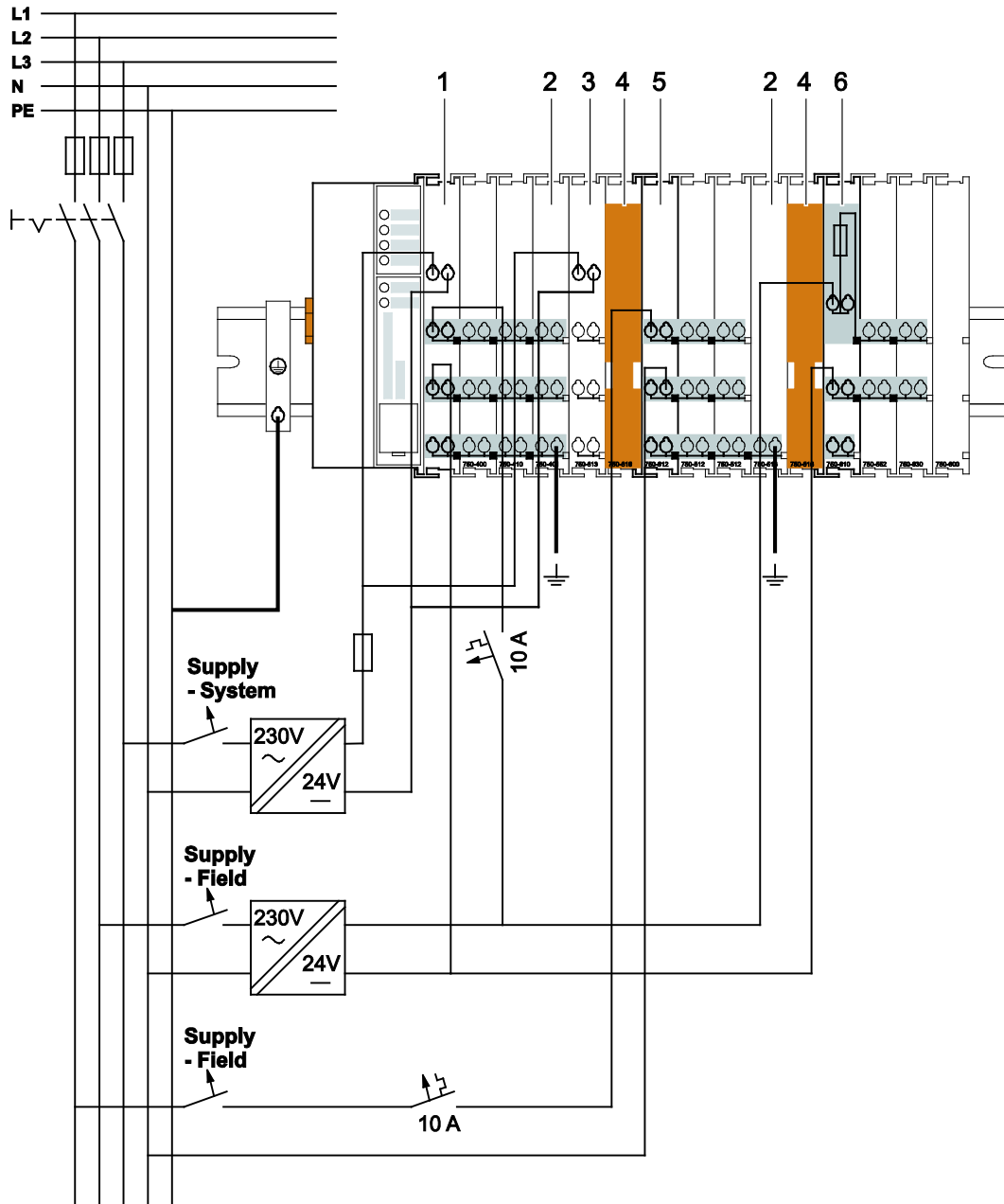

Figure 17: Supply example for standard couplers/controllers and extended ECO couplers

Table 9: Caption for figure “Supply example for fieldbus coupler/controller”

Pos.	Description
1	Power Supply on coupler via external Supply Module
2	Power Supply with optional ground
3	Internal System Supply Module
4	Separation module recommended
5	Supply Module passive
6	Supply Module with fuse carrier/diagnostics

3.6.6 Power Supply Unit

The WAGO-I/O-SYSTEM 750 requires a 24 VDC voltage (system supply).

Note



Recommendation

A stable power supply cannot always be assumed everywhere. Therefore, you should use regulated power supplies to ensure the quality of the supply voltage (see also table “WAGO power supply units”).

For brief voltage dips, a buffer (200 µF per 1 A load current) must be provided.

Note



Power failure time not acc. IEC 61131-2!

Note that the power failure time of 10 ms acc. IEC 61131-2 is not maintained in a maximum configuration.

The power demand must be determined individually depending on the entry point of the field supply. All loads through field devices and I/O modules must be taken into account. The field supply also impacts the I/O modules because the input and output drivers of some I/O modules require the voltage of the field supply.

Note



System and field supply must be isolated!

The system supply and field supply must be isolated to ensure bus operation in the event of short circuits on the actuator side.

Table 10: WAGO Power Supply Unit (Selection)

WAGO Power Supply Unit	Description
787-612	Primary switched mode; DC 24 V; 2,5 A Input nominal voltage AC 230 V
787-622	Primary switched mode; DC 24 V; 5 A Input nominal voltage AC 230 V
787-632	Primary switched mode; DC 24 V; 10 A Input nominal voltage AC 230/115 V
288-809	Rail-mounted modules with universal mounting carrier AC 115 V/DC 24 V; 0,5 A
288-810	AC 230 V/DC 24 V; 0,5 A
288-812	AC 230 V/DC 24 V; 2 A
288-813	AC 115 V/DC 24 V; 2 A

3.7 Grounding

3.7.1 Grounding the DIN Rail

3.7.1.1 Framework Assembly

When setting up the framework, the carrier rail must be screwed together with the electrically conducting cabinet or housing frame. The framework or the housing must be grounded. The electrical connection is established via the screw. Thus, the carrier rail is grounded.



DANGER

Ensure sufficient grounding is provided!

You must take care to ensure the flawless electrical connection between the carrier rail and the frame or housing in order to guarantee sufficient grounding.

3.7.1.2 Insulated Assembly

Insulated assembly has been achieved when there is constructively no direct ohmic contact between the cabinet frame or machine parts and the carrier rail. Here, the earth ground must be set up via an electrical conductor accordingly valid national safety regulations.



Note

Recommendation

The optimal setup is a metallic assembly plate with grounding connection which is electrically conductive linked to the carrier rail.

The separate grounding of the carrier rail can be easily set up with the aid of the WAGO ground wire terminals.

Table 11: WAGO ground wire terminals

Order No.	Description
283-609	1-conductor ground (earth) terminal block make an automatic contact to the carrier rail; conductor cross section: 0.2 mm ² ... 16 mm ² Note: Also order the end and intermediate plate (283-320).

3.7.2 Grounding Function

The grounding function increases the resistance against disturbances from electro-magnetic interferences. Some components in the I/O system have a carrier rail contact that dissipates electro-magnetic disturbances to the carrier rail.

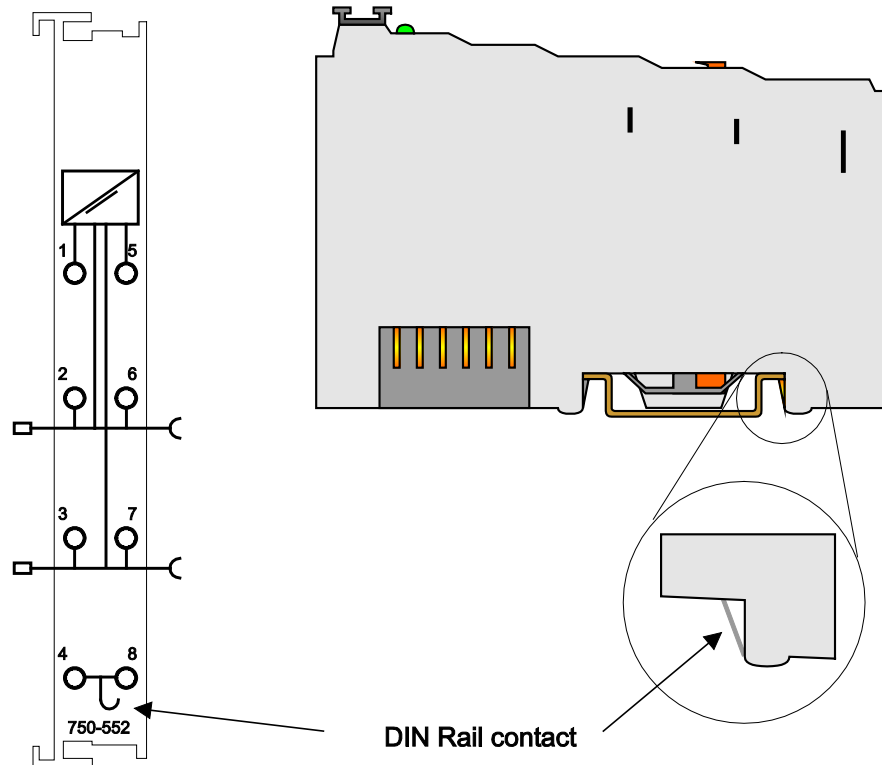

Figure 18: Carrier rail contact (example)



DANGER

Ensure sufficient grounding is provided!

You must take care to ensure the direct electrical connection between the carrier rail contact and the carrier rail.

The carrier rail must be grounded.

For information on carrier rail properties, see section “Mounting” > ... > “Carrier Rail Properties”.

The bottom CAGE CLAMP® connectors of the supply modules enable optional connection of a field-side functional ground. This potential is made available to the I/O module arranged on the right through the spring-loaded contact of the three power contacts. Some I/O modules are equipped with a knife-edge contact that taps this potential. This forms a potential group with regard to functional ground with the I/O module arranged on the left.

3.8 Shielding

3.8.1 General

Use of shielded cables reduces electromagnetic interference and thus increases signal quality. Measurement errors, data transmission errors and interference due to excessive voltage can be prevented.

Note



Connect the cable shield to the ground potential!

Integrated shielding is mandatory to meet the technical specifications in regards to measuring accuracy. Connect the cable shield and ground potential at the inlet to the cabinet or housing. This allows induced interference to dissipate and to be kept away from devices in the cabinet or housing.

Note



Improve shielding performance by placing the shield over a large area!

Higher shielding performance is achieved via low-impedance connection between shield and ground. For this purpose, connect the shield over a large surface area, e.g., WAGO shield connecting system. This is especially recommended for large-scale systems where equalizing current or high impulse-type currents caused by atmospheric discharge may occur.

Note



Keep data and signal lines away from sources of interference!

Route data and signal lines separately from all high voltage cables and other sources of high electromagnetic emission (e.g., frequency converter or drives).

3.8.2 Bus cables

The shielding of the bus line is described in the respective configuration guidelines and standards of the bus system.

3.8.3 Signal lines

I/O modules for analog signals and some interface I/O modules are equipped with shield clamps.

Note



Use shielded signal lines!

Only use shielded signal lines for analog signals and I/O modules which are equipped with shield clamps. Only then can you ensure that the accuracy and interference immunity specified for the respective I/O module can be achieved even in the presence of interference acting on the signal cable.

3.8.4 WAGO Shield Connecting System

The WAGO shield connecting system consists of shield clamping saddles, busbars and various mounting carriers. These components can be used to achieve many different configurations.



Figure 19: Example of the WAGO shield connecting system

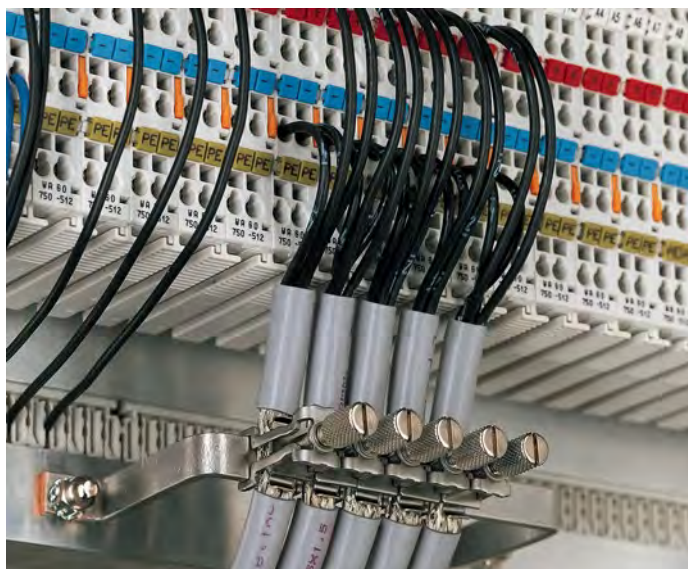

Figure 20: Application of the WAGO shield connecting system

4 Device Description

The fieldbus coupler 750-375 connects the WAGO-I/O-SYSTEM 750/753 to PROFINET IO, the open, real-time industrial ETHERNET automation standard.

Any combination of supported digital, analog and complex I/O modules of the WAGO-I/O-SYSTEM 750/753 can be used here.

In the context of PROFINET IO, the fieldbus coupler represents the connected peripheral as a distributed field device and assumes the role of an IO device.

Thanks to the integrated 2-port switch it is possible to setup cost-effective line topologies without the need for additional infrastructure components.

A DIP switch can optionally be used to address the station referring to PROFIBUS DP devices. Thus a DCP based software tool could be unnecessary. Furthermore the factory settings of the fieldbus coupler can be restored by means of the DIP switch.

The diagnostic concept is fully compliant to PROFINET IO Standard IEC 61158. Standard LEDs ensure an extensive point-of-care-testing and simplify the commissioning of the node.

The familiar commissioning tools such as WAGO-I/O-CHECK can connect to the fieldbus coupler via existent service interface.

The lines for supplying the required operating voltages are connected via the CAGE CLAMP® connections.

Note



Unsupported I/O modules!

Please note that the following I/O modules are not supported:

- KNX/EIB/TP1 module 75x-646
- LON® FTT module 75x-648
- PROFIsafe V1 modules 750-660/000-001 and 750-665/000 001.

With firmware version 01 and 02, the following I/O modules cannot be operated:

- Proportional Valve Module 75x-632
- 4-channel IO-Link Master 75x-657
- CAN Gateway 75x-658.

Starting from firmware version 03, the HART values of the 2-channel analog input modules HART 75x-482 and 75x 484 can be configured to the input process image.

4.1 Fieldbus Coupler Properties

4.1.1 General Specifications

The fieldbus coupler has the following specifications:

- 2 x RJ-45 100BaseTX via integrated switch
- Transmission speed up to 100 Mbit/s full-duplex or half-duplex with and without auto-negotiation
- Flexible configuration of digital I/O modules
- Variation of the physical peripheral layout by using active spacer modules (starting from FW 03)
- Event granular channel diagnosis
- Configurable substitute value behavior for each output channel in the event of failure
- Configurable substitute values for each output channel in the event of failure

4.1.2 PROFINET IO Properties

The fieldbus coupler as a station proxy of the IO device has the following properties and specifications.

Table 12: PROFINET IO properties and specifications

Properties	
RT communication (RT_CLASS_1) acc. to Conformance Class B	Yes
• Send Clock	1 ms
• Min. Send Cycle	1 ms
• Max. Send Cycle	512 ms
IRT communication (RT_CLASS_3) acc. to Conformance Class C	Yes (FW 03)
• Send Clock	1, 2, 4 ms
• Min. Send Cycle	1 ms
• Max. Send Cycle	64 ms
Media Redundancy using Ring Topology (MRP)	Yes (FW 03)
No. of IO controller application relationships (IOCAR)	2
• No. of RT_CLASS_3 of these	1 (FW 03)
No. of IO supervisor application relationships (IOSAR)	1
Device access or implicit application relationship (Implicit AR)	Yes
No. of communication relationships (IOCR) for input data per IOCAR and IOSAR	1
No. of communication relationships (IOCR) for output data per IOCAR and IOSAR	1
No. of multicast communication relationships (IOMCR) as provider	0
No. of multicast communication relationships (IOMCR) as consumer	0
"Shared Device" functionality	Yes
"Shared Input" functionality	No
Max. number of modules incl. station proxies (DAP, slot 0)	251 (0-250)
No. of submodules of the station proxy (DAP, slot 0)	4
No. of submodules per module (slot 1-250)	1
Max. user data length of the provider telegram incl. process data qualifier (IOxS) in bytes	736
Max. user data length of the consumer telegram incl. process data qualifier (IOxS) in bytes	736
Max. application data length for inputs without process data qualifier (IOxS) in bytes	512
Max. application data length for outputs without process data qualifier (IOxS) in bytes	512

4.1.3 Implemented Protocols and Services

In addition to the PROFINET IO specific protocols RT, IRT (FW 03), DCP and CLRPC the following ETHERNET based protocols and services are available:

- LLDP
- MRP (FW 03)
- IPv4
 - ICMP (ping)
 - UDP
 - SNMP V1/V2 (MIB-2)
 - TCP
 - HTTP

Information



More information on supported protocols!

You can learn more about supported protocols in the respective sections of the "Fieldbus Communication" chapter.

4.1.4 Supported Profiles for PROFINET IO

The fieldbus coupler also supports the following profiles in conjunction with the particular I/O modules:

- PROFI-safe V2.4
- iPar-Server V1.0.1
- PROFIenergy V1.0

Information



More information on supported profiles!

You can learn more about supported profiles in the "Function Description" chapter in the sections "Using Fail-Safe I/O Modules (PROFI-safe V2)", "Controlling Digital and Analog Output Modules per PROFIenergy" or "Individual Parameterization of I/O Modules via iPar Server".

4.2 View

The view shows three different units of the device:

- There is a DIP switch at the top left and below that the fieldbus connection (X1, X2).
- LEDs for operation status, bus communication, error messages and diagnostics, as well as the service interface behind the flap are in the middle area.
- The right side shows a power supply unit for the system supply and for the field power of the attached I/O modules via power jumper contacts. LEDs show the status of the operating voltage for the system and field power (jumper contacts).

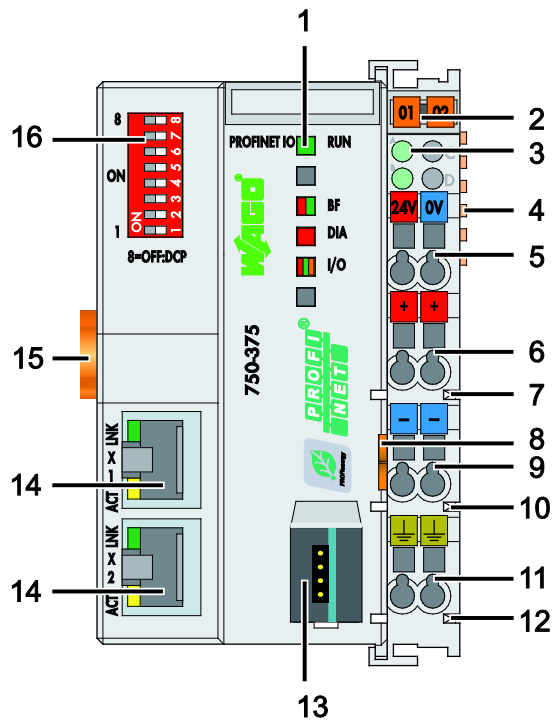

Figure 21: View Fieldbus coupler PROFINET IO advanced

Table 13: Legend to the View PROFINET IO advanced Fieldbus Coupler

Pos.	Designation	Meaning	Details see Section:
1	RUN, BF, DIA, I/O	Status LEDs PROFINET IO	“Device Description“ > “Display Elements“
2	---	Group marking carrier (retractable) with additional marking possibility on two miniature WSB markers	---
3	A, B or C	Status LED's System/Field Supply	“Device Description“ > “Display Elements“
4	---	Data Contacts	“Connect Devices“ > “Data Contacts/Internal Bus“
5	24 V, 0 V	CAGE CLAMP® Connections System Supply	“Connect Devices“ > “Connecting a conductor to the CAGE CLAMP®“
6	+	CAGE CLAMP® Connections Field Supply 24 VDC	“Connect Devices“ > “Connecting a conductor to the CAGE CLAMP®“
7	---	Power Jumper Contact 24 VDC	“Connect Devices“ > “Power Contacts/Field Supply“
8	---	Unlocking Lug	“Mounting“ > “Inserting and Removing Devices“
9	-	CAGE CLAMP® Connections Field Supply 0 V	“Connect Devices“ > “Connecting a conductor to the CAGE CLAMP®“
10	---	Power Jumper Contact 0 V	“Connect Devices“ > “Power Contacts/Field Supply“
11	(Ground)	CAGE CLAMP® Connections Field Supply (Ground)	“Connect Devices“ > “Connecting a conductor to the CAGE CLAMP®“
12	---	Power Jumper Contact (Ground)	“Connect Devices“ > “Power Contacts/Field Supply“
13	---	Service Interface (open flap)	“Device Description“ > “Operating Elements“
14	X1, X2	Fieldbus connection 2 x RJ-45 as 2-Port Switch	“Device Description“ > “Connectors“
15	---	Locking Disc	“Mounting“ > “Inserting and Removing Devices“
16	---	DIP Switch	“Device Description“ > “Operating Elements“

4.3 Connectors

4.3.1 Device Supply

The device is powered via terminal blocks with CAGE CLAMP® connections.

The device supply generates the necessary voltage to power the electronics of the device and the internal electronics of the connected I/O modules.

The fieldbus interface is galvanically separated to the electrical potential of the device.

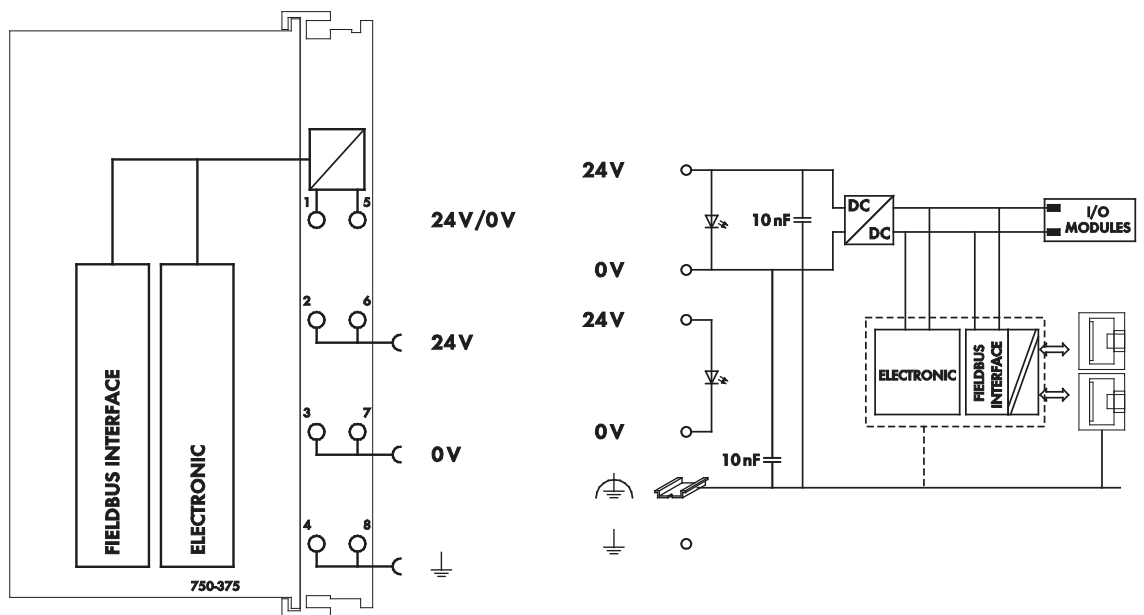

Figure 22: Device Supply

4.3.2 Fieldbus Connection

The fieldbus is connected via two RJ-45 plugs.

Via these plugs the ports of the integrated switch are physically connected to the network by cable stated below.

The integrated switch works in cut-through operation.

The PHYs of each port support the transmission rates 10/100 Mbit as well as the transmission modes full-duplex, half-duplex and autonegotiation.

The wiring of the RJ-45 plugs corresponds to the specifications for 100BaseTX.

The PROFINET standard prescribes a category 5 twisted pair cable to be used.

Cable types S-UTP (Screened Unshielded Twisted Pair) and STP (Shielded Twisted Pair) with a maximum segment length of 100 m or approximately 328.08 feet can be used.

The RJ-45 socket is arranged physically lower, allowing the coupler to fit in an 80 mm high enclosure once connected.

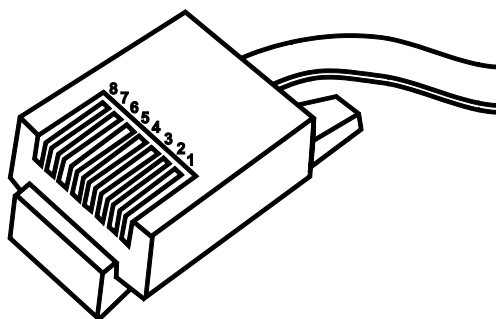

Figure 23: RJ-45 Connector

Table 14: RJ-45 Connector and RJ-45 Connector Configuration

Contact	Signal	
1	TD +	Transmit +
2	TD -	Transmit -
3	RD +	Receive +
4		free
5		free
6	RD -	Receive -
7		free
8		free

NOTICE

Not for use in telecommunication circuits!

Only use devices equipped with ETHERNET or RJ-45 connectors in LANs.
Never connect these devices with telecommunication networks.

4.4 Display Elements

The operating condition of the fieldbus coupler or the node is displayed with the help of illuminated indicators in the form of light-emitting diodes (LEDs). The LED information is routed to the top of the case by light guides. In some cases, the LEDs are multi-colored (red, green or orange).

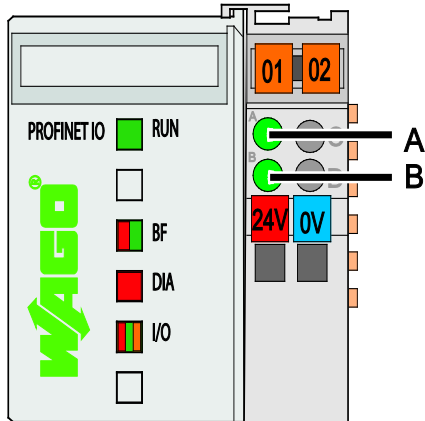

Figure 24: Display Elements

For the diagnostics of the different domains fieldbus, node and supply voltage, the LEDs can be divided into three groups:

Table 15: Display Elements Fieldbus Status

LED	Color	Meaning
RUN	green	provides information on the operational readiness of the fieldbus coupler and the PROFIenergy status of the station.
BF	red/green	provides information on the current status of the PROFINET IO data exchange (red) and it is used for device identification (green).
DIA	red	indicates the upcoming diagnoses as well as differences between the expected and real configuration.

Table 16: Display Elements Node Status

LED	Color	Meaning
I/O	red/green/ orange	indicates a state of start-up (orange) as well as the operation of the node (green) and signals via a blink code (red) faults encountered.

Table 17: Display Elements Supply Voltage

LED	Color	Meaning
A	green	indicates the status of the operating voltage – system
B	green	indicates the status of the operating voltage – power jumper contacts

Information



More information about the LED Signaling

Read the detailed description for the evaluation of the displayed LED state in the section “Diagnostics” > “LED Signaling”.

The LEDs on the two RJ-45 fieldbus connection sockets display the network connection:

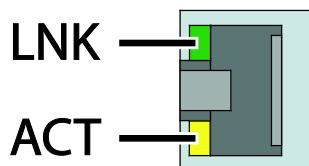

Figure 25: Display Elements Fieldbus Connection RJ-45

Table 18: Display Elements Fieldbus Connection RJ-45

LED	Color	Meaning
LNK	green	indicates the connection to the physical network (Link)
ACT	green	indicates network activities

4.5 Operating Elements

4.5.1 Service Interface

The service interface is located behind the flap.

The service interface is used for the communication with the WAGO-I/O-CHECK and the WAGO-SEDI.

Note



No firmware update via configuration interface!

Note that a firmware update via the service interface using FBC update is not possible.

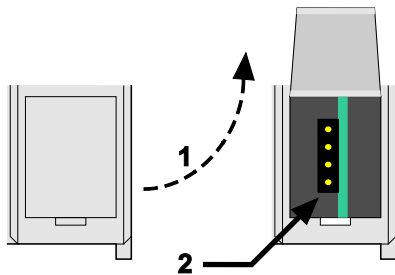

Figure 26: Service Interface (closed and opened flap)

Table 19: Legend for figure “Service Interface (closed and opened flap)”

Number	Description
1	Open closed
2	View Service Interface

NOTICE

Device must be de-energized!

To prevent damage to the device, unplug and plug in the communication cable only when the device is de-energized!

The connection to the 4-pin header under the cover flap can be realized via the communication cables with the item numbers 750-920 and 750-923 or via the Bluetooth® Adapter with the item number 750-921.

4.5.2 DIP Switch

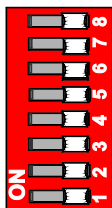

Figure 27: DIP Switch (for example setting “0”)

The DIP switch can be used to assign a device name to the fieldbus coupler, which can be selected from two pre-defined character strings and can be instantiated each. It is also possible to reset the fieldbus coupler to the factory setting.

Note



DIP switch settings only applied after reset!

Please note that any settings made are only applied during start-up, i.e. after switching on the supply voltage (hardware reset) or in operation after software reset. If one of the specified resets is not carried out, changes to the switch settings are not applied during operation!

Table 20: DIP switch - Explanation of the 8 slide switches

Slide switch	Explanation	Description
No. 8	Specification of the process for station naming	The position of slide switch No. 8 determines the process for station naming. In the OFF position, the device uses the name saved in persistent memory represented as an empty character string (NIL, "") in the default setting. The "DCP Set" service must be used to change the name of the device in the EEPROM. In the ON position, the device uses the instance of sections of two predetermined device names determined by slide switch Nos. 1 - 7 as listed below.
No. 7	Specification of the predefined device name section	Provided that station naming is activated via the DIP switch (slide switch No. 8 in position ON), the position of slide switch No. 7 determines the fixed part of the device name. In the OFF position, the device uses the character string "wago-750-375" as the fixed part of the device name. In the ON position, the character string "wagox750x375" is used.
No. 6	Reset to factory settings	If all slide switches except No. 6 are in position 'OFF' the fieldbus coupler waits after start-up for the operation of any slide switch to reset the factory settings before finally starting the firmware. While waiting the RUN-LED is flashing at a frequency of 1 Hz. After operation of at least one slide switch the RUN-LED flashes at 2 Hz while persistent data structures are initialized. Subsequent an automatic restart of the firmware is initiated. All PROFINET IO specific settings, e.g. the persistent device name or the persistent IP settings, contain the delivery states afterwards.
No. 1...6	Specification of the device name instance	Slide switches 1 - 6 specify the instance of the predefined device name section. If all slide switches are in the OFF position, nothing (NIL) is added to the specified character string. In any other case, a separator is added depending on the position of slide switch No. 7, either "-" (OFF) or "x" (ON). That is followed by a decimal point formed from the positions of slide switches No. 1 - 6. This decimal value of the device name instance is based on the following rule: <div style="border: 1px solid black; padding: 10px; width: fit-content; margin: 10px auto;"> $\text{Instance} = \sum_{n=1}^6 \text{Switch position (n)} * 2^{(n-1)}$ </div> In the ON position, the respective switch position takes the value "1" and in the OFF position, the value "0".

Example:

The following example of a DIP switch setting illustrates the structure of the respective device name.

Slide switch Nos. 1, 2, 4, 7 and 8 are moved to the ON position.

Table 21: Example DIP switch setting

Slide switch	Position	Description
No. 8	ON	The device uses the instances specified via slide switch No. 1 - 7.
No. 7	ON	The device uses character string "wagox750x375".
No. 1	ON	The "x" separator is added (slide switch No. 7 ON). Based on the following rule: <div style="border: 1px solid black; padding: 10px; margin: 10px auto; width: fit-content;"> $\text{Instance} = \sum_{n=1}^6 \text{Switch position (n)} * 2^{(n-1)}$ </div> The decimal value of the device name instance results: $\begin{aligned} \text{Instance} &= 1*2^0 + 1*2^1 + 0*2^2 + 1*2^3 + 0*2^4 + 0*2^5 \\ &= 1 + 2 + 0 + 8 + 0 + 0 \\ &= 11 \end{aligned}$
No. 2	ON	
No. 3	OFF	
No. 4	ON	
No. 5	OFF	
No. 6	OFF	

The device name "wagox750x375x11" results from the example DIP switch setting.

Note**Assigning the address via DCP!**

The station is normally named as part of the configuration by assigning the device name via DCP.

More information is available in the chapter "Fieldbus Communication" >>... >> "DCP".

4.6 Technical Data

4.6.1 Device Data

Table 22: Technical data – Device data

Width	62 mm
Height (from upper-edge of DIN 35)	65 mm
Length	100 mm
Weight	160 g
Degree of protection	IP 20
Fieldbus	
Max. input process image	512 bytes
Max. output process image	512 bytes
Number of I/O modules with bus extension	64 250
Configuration	via PC
PROFINET IO features	Integrated 2-port switch; Auto-negotiation, Auto-MDIX; Isochronous Real Time Communication (FW 03); Send clock: 1 ms (RT); 1, 2, 4 ms (IRT); Device replacement without programming tool; Shared device
Protocols	Topology detection / LLDP, Network diagnostics / SNMP / MIB-2, Media redundancy / MRP (FW 03), Web server / http
Profiles supported	PROFIsafe V2.4, iPar-Server V1.0.1, PROFIenergy V1.0
ID code	Vendor-ID: 0x011D; Device-ID: 0x02EE; Module-ID: 0x01010177 (FW 01/02), 0x02010177 (FW 03)

4.6.2 System Data

Table 23: Technical data – System data

No. of couplers connected to IO controller	limited by PROFINET specification
Transmission medium	Twisted Pair S-UTP 100 Ω cat.
Max. length of fieldbus segment	100 m between switch and 750-375; max. length of network limited by PROFINET specification
Baud rate	10/100 Mbit/s (ETHERNET protocols), 100 Mbit/s full duplex (PROFINET IO)
Transmission method	100Base-TX
Buscoupler connection	2 x RJ-45
PROFINET IO standard	V2.2 (V2.3 ready) Conformance Class B Conformance Class C (FW 03)

4.6.3 Supply

Table 24: Technical data – Supply

Power supply	DC 24 V (-25 % ... +30 %)
Efficiency of the power supply (typ.) at nominal load (24 V)	90 %
Input current typ. At rated load (24 V)	500 mA
Internal current consumption (5 V)	400 mA
Total current for I/O modules (5 V)	1700 mA
Isolation	500 V system/supply

4.6.4 Accessories

Table 25: Technical Data – Accessories

Miniature WSB Quick marking system

4.6.5 Connection Type

Table 26: Technical Data – Field Wiring

Wire connection	CAGE CLAMP®
Cross section	0.08 mm ² ... 2.5 mm ² , AWG 28 ... 14
Stripped lengths	8 mm ... 9 mm / 0.33 in

Table 27: Technical Data – Power Jumper Contacts

Power jumper contacts	blade/spring contact, self-cleaning
Voltage drop at I _{max.}	< 1 V/64 modules

Table 28: Technical Data – Internal Bus

Data contacts	slide contact, hard gold plated, self-cleaning
---------------	--

4.6.6 Climatic Environmental Conditions

Table 29: Technical Data – Climatic environmental conditions

Operating temperature range	0 °C ... 55 °C
Operating temperature range for components with extended temperature range (750-xxx/025-xxx)	-20 °C ... +60 °C
Storage temperature range	-25 °C ... +85 °C
Storage temperature range for components with extended temperature range (750-xxx/025-xxx)	-40 °C ... +85 °C
Relative humidity	max. 5 % ... 95 % without condensation
Resistance to harmful substances	Acc. to IEC 60068-2-42 and IEC 60068-2-43
Maximum pollutant concentration at relative humidity < 75 %	SO ₂ ≤ 25 ppm H ₂ S ≤ 10 ppm
Special conditions	Ensure that additional measures for components are taken, which are used in an environment involving: – dust, caustic vapors or gases – ionizing radiation

4.7 Approvals



Information

More information about approvals.

Detailed references to the approvals are listed in the document “Overview Approvals **WAGO-I/O-SYSTEM 750**”, which you can find via the internet under: www.wago.com > SERVICES > DOWNLOADS > Additional documentation and information on automation products > WAGO-I/O-SYSTEM 750 > System Description.

The following approvals have been granted to the basic version and all variations of 750-375 fieldbus couplers/controllers:

 Conformity Marking

 cUL_{US} UL508

4.8 Standards and Guidelines

750-375 meets the following requirements on emission and immunity of interference:

EMC CE-Immunity to interference acc. to EN 61000-6-2: 2005

EMC CE-Emission of interference acc. to EN 61000-6-3: 2007

5 Mounting

5.1 Installation Position

Along with horizontal and vertical installation, all other installation positions are allowed.

Note



Use an end stop in the case of vertical mounting!

In the case of vertical assembly, an end stop has to be mounted as an additional safeguard against slipping.

WAGO order no. 249-116 End stop for DIN 35 rail, 6 mm wide

WAGO order no. 249-117 End stop for DIN 35 rail, 10 mm wide

5.2 Total Extension

The length of the module assembly (including one end module of 12mm width) that can be connected to the 750-375 is 780 mm. When assembled, the I/O modules have a maximum length of 768 mm.

Examples:

- 64 I/O modules of 12 mm width can be connected to one coupler/controller.
- 32 I/O modules of 24 mm width can be connected to one coupler/controller.

Exception:

The number of connected I/O modules also depends on which type of coupler/controller is used. For example, the maximum number of I/O modules that can be connected to a PROFIBUS coupler/controller is 63 without end module.

NOTICE

Observe maximum total length of a node!

The maximum total length of a node without a coupler/controller must not exceed 780 mm. Furthermore, you must observe restrictions made on certain types of couplers/controllers.



Note

Increase total length using a WAGO internal data bus extension module!

Using an internal data bus extension module from WAGO, you can increase the total length of the fieldbus node. In this type of configuration, you must connect a 750-627 Bus Extension End Module to the last module of the node.

You then connect the 750-627 module to the 750-628 Coupler Module of the next I/O module assembly via RJ-45 cable.

You can connect up to 10 internal data bus extension coupler modules 750-628 to an internal data bus extension end module 750-627. In this manner, you can logically connect up to 10 module assemblies to a 750-375, dividing a fieldbus node into 11 assemblies maximum.

The maximum cable length between two assemblies is 5 meters. For additional information, refer to the 2750-627/-628 Modules2 manual. The total cable length for a fieldbus node is 70 meters.

5.3 Mounting onto Carrier Rail

5.3.1 Carrier Rail Properties

All system components can be snapped directly onto a carrier rail in accordance with the European standard EN 50022 (DIN 35).

NOTICE

Do not use any third-party carrier rails without approval by WAGO!

WAGO Kontakttechnik GmbH & Co. KG supplies standardized carrier rails that are optimal for use with the I/O system. If other carrier rails are used, then a technical inspection and approval of the rail by WAGO Kontakttechnik GmbH & Co. KG should take place.

Carrier rails have different mechanical and electrical properties. For the optimal system setup on a carrier rail, certain guidelines must be observed:

- The material must be non-corrosive.
- Most components have a contact to the carrier rail to ground electro-magnetic disturbances. In order to avoid corrosion, this tin-plated carrier rail contact must not form a galvanic cell with the material of the carrier rail which generates a differential voltage above 0.5 V (saline solution of 0.3 % at 20°C).
- The carrier rail must optimally support the EMC measures integrated into the system and the shielding of the I/O module connections.
- A sufficiently stable carrier rail should be selected and, if necessary, several mounting points (every 20 cm) should be used in order to prevent bending and twisting (torsion).
- The geometry of the carrier rail must not be altered in order to secure the safe hold of the components. In particular, when shortening or mounting the carrier rail, it must not be crushed or bent.
- The base of the I/O components extends into the profile of the carrier rail. For carrier rails with a height of 7.5 mm, mounting points are to be riveted under the node in the carrier rail (slotted head captive screws or blind rivets).
- The medal springs on the bottom of the housing must have low-impedance contact with the DIN rail (wide contact surface is possible).

5.3.2 WAGO DIN Rail

WAGO carrier rails meet the electrical and mechanical requirements shown in the table below.

Table 30: WAGO DIN Rail

Order number	Description
210-113 /-112	35 x 7.5; 1 mm; steel yellow chromated; slotted/unslotted
210-114 /-197	35 x 15; 1.5 mm; steel yellow chromated; slotted/unslotted
210-118	35 x 15; 2.3 mm; steel yellow chromated; unslotted
210-198	35 x 15; 2.3 mm; copper; unslotted
210-196	35 x 7.5; 1 mm; aluminum; unslotted

5.4 Spacing

The spacing between adjacent components, cable conduits, casing and frame sides must be maintained for the complete fieldbus node.

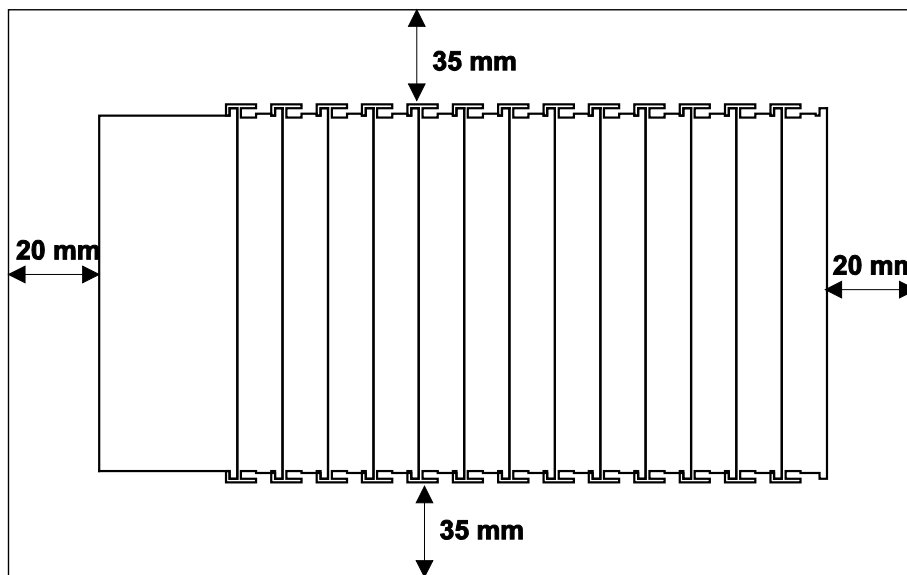

Figure 28: Spacing

The spacing creates room for heat transfer, installation or wiring. The spacing to cable conduits also prevents conducted electromagnetic interferences from influencing the operation.

5.5 Mounting Sequence

Fieldbus couplers/controllers and I/O modules of the WAGO-I/O-SYSTEM 750 are snapped directly on a carrier rail in accordance with the European standard EN 50022 (DIN 35).

The reliable positioning and connection is made using a tongue and groove system. Due to the automatic locking, the individual devices are securely seated on the rail after installation.

Starting with the fieldbus coupler/controller, the I/O modules are mounted adjacent to each other according to the project design. Errors in the design of the node in terms of the potential groups (connection via the power contacts) are recognized, as the I/O modules with power contacts (blade contacts) cannot be linked to I/O modules with fewer power contacts.

CAUTION

Risk of injury due to sharp-edged blade contacts!

The blade contacts are sharp-edged. Handle the I/O module carefully to prevent injury.

NOTICE

Insert I/O modules only from the proper direction!

All I/O modules feature grooves for power jumper contacts on the right side. For some I/O modules, the grooves are closed on the top. Therefore, I/O modules featuring a power jumper contact on the left side cannot be snapped from the top. This mechanical coding helps to avoid configuration errors, which may destroy the I/O modules. Therefore, insert I/O modules only from the right and from the top.

Note



Don't forget the bus end module!

Always plug a bus end module 750-600 onto the end of the fieldbus node! You must always use a bus end module at all fieldbus nodes with WAGO-I/O-SYSTEM 750 fieldbus couplers/controllers to guarantee proper data transfer.

5.6 Inserting and Removing Devices

NOTICE

Perform work on devices only if they are de-energized!

Working on energized devices can damage them. Therefore, turn off the power supply before working on the devices.

5.6.1 Inserting the Fieldbus Coupler/Controller

1. When replacing the fieldbus coupler/controller for an already available fieldbus coupler/controller, position the new fieldbus coupler/controller so that the tongue and groove joints to the subsequent I/O module are engaged.
2. Snap the fieldbus coupler/controller onto the carrier rail.
3. Use a screwdriver blade to turn the locking disc until the nose of the locking disc engages behind the carrier rail (see the following figure). This prevents the fieldbus coupler/controller from canting on the carrier rail.

With the fieldbus coupler/controller snapped in place, the electrical connections for the data contacts and power contacts (if any) to the possible subsequent I/O module are established.

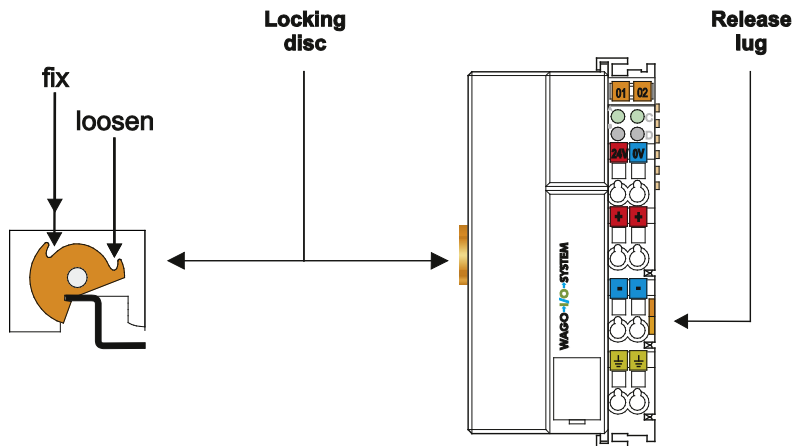

Figure 29: Unlocking lug standard fieldbus coupler/controller (example)

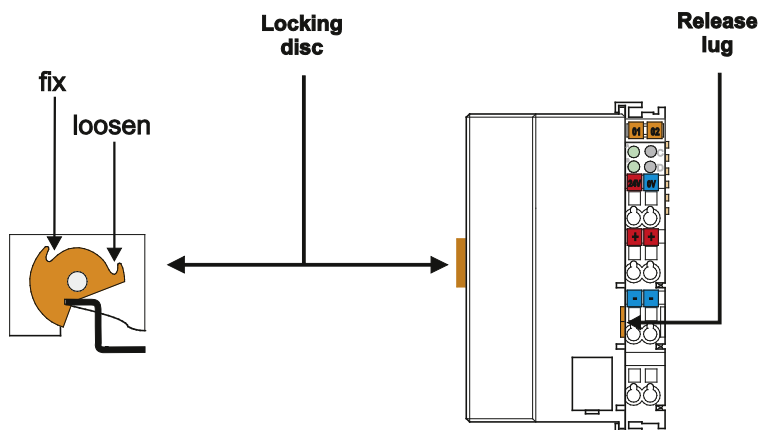

Figure 30: Unlocking lug of extended ECO fieldbus coupler (example)

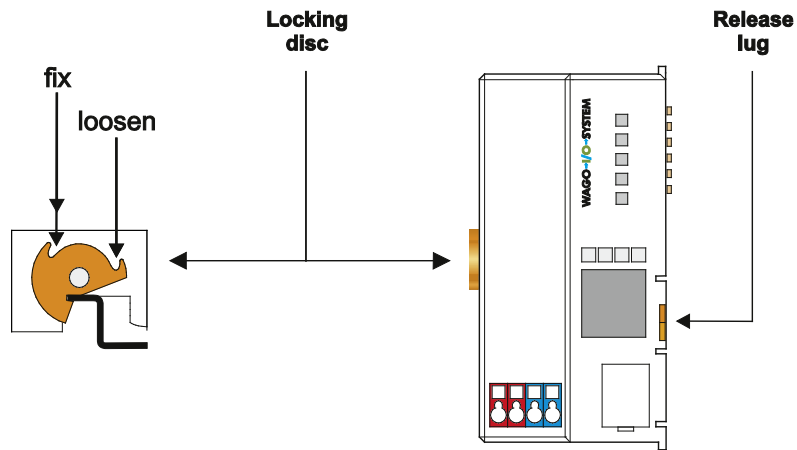

Figure 31: Unlocking lug ECO coupler

5.6.2 Removing the Fieldbus Coupler/Controller

1. Use a screwdriver blade to turn the locking disc until the nose of the locking disc no longer engages behind the carrier rail.
2. Remove the fieldbus coupler/controller from the assembly by pulling the release tab.

Electrical connections for data or power contacts to adjacent I/O modules are disconnected when removing the fieldbus coupler/controller.

5.6.3 Inserting the I/O Module

1. Position the I/O module so that the tongue and groove joints to the fieldbus coupler/controller or to the previous or possibly subsequent I/O module are engaged.



Figure 32: Insert I/O module (sample)

2. Press the I/O module into the assembly until the I/O module snaps into the carrier rail.

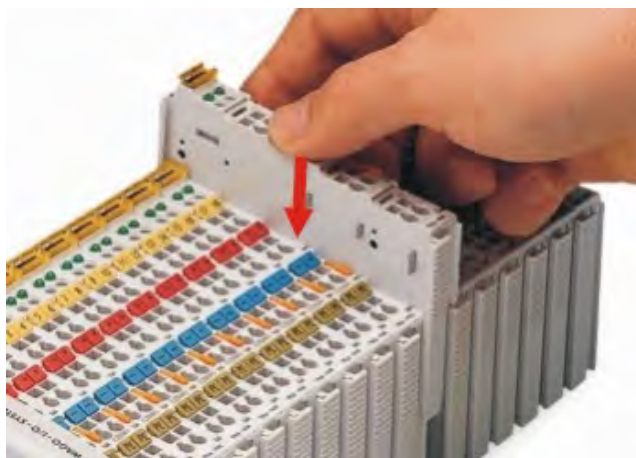

Figure 33: Snap the I/O module into place (sample)

With the I/O module snapped in place, the electrical connections for the data contacts and power jumper contacts (if any) to the fieldbus coupler/controller or to the previous or possibly subsequent I/O module are established.

5.6.4 Removing the I/O Module

1. Remove the I/O module from the assembly by pulling the release tab.

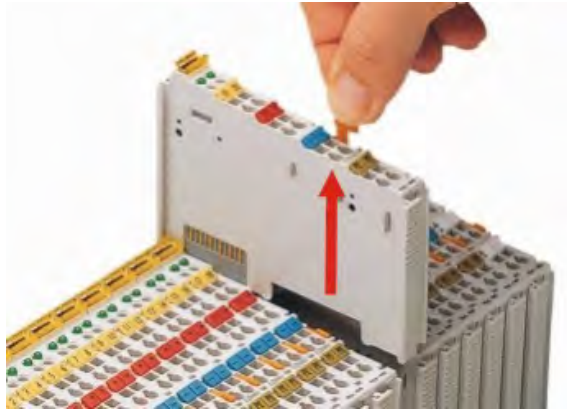

Figure 34: Removing the I/O module (sample)

Electrical connections for data or power jumper contacts are disconnected when removing the I/O module.

6 Connect Devices

6.1 Data Contacts/Internal Bus

Communication between the fieldbus coupler/controller and the I/O modules as well as the system supply of the I/O modules is carried out via the internal bus. It is comprised of 6 data contacts, which are available as self-cleaning gold spring contacts.

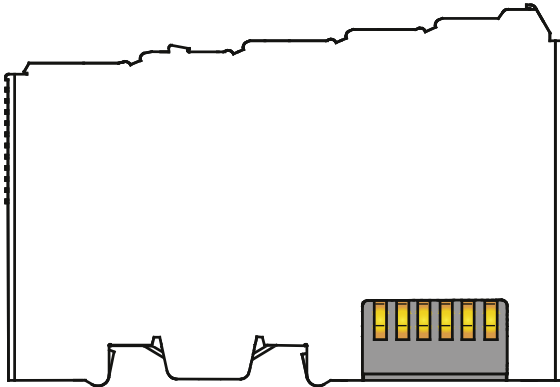

Figure 35: Data contacts

NOTICE

Do not place the I/O modules on the gold spring contacts!

Do not place the I/O modules on the gold spring contacts in order to avoid soiling or scratching!

NOTICE



Ensure that the environment is well grounded!

The devices are equipped with electronic components that may be destroyed by electrostatic discharge. When handling the devices, ensure that the environment (persons, workplace and packing) is well grounded. Avoid touching conductive components, e.g. data contacts.

6.2 Power Contacts/Field Supply

⚠ CAUTION

Risk of injury due to sharp-edged blade contacts!

The blade contacts are sharp-edged. Handle the I/O module carefully to prevent injury.

Self-cleaning power jumper contacts used to supply the field side are located on the right side of most of the fieldbus couplers/controllers and on some of the I/O modules. These contacts come as touch-proof spring contacts. As fitting counterparts the I/O modules have male contacts on the left side.

Power jumper contacts

Blade	0	0	3	2
Spring	0	3	3	2

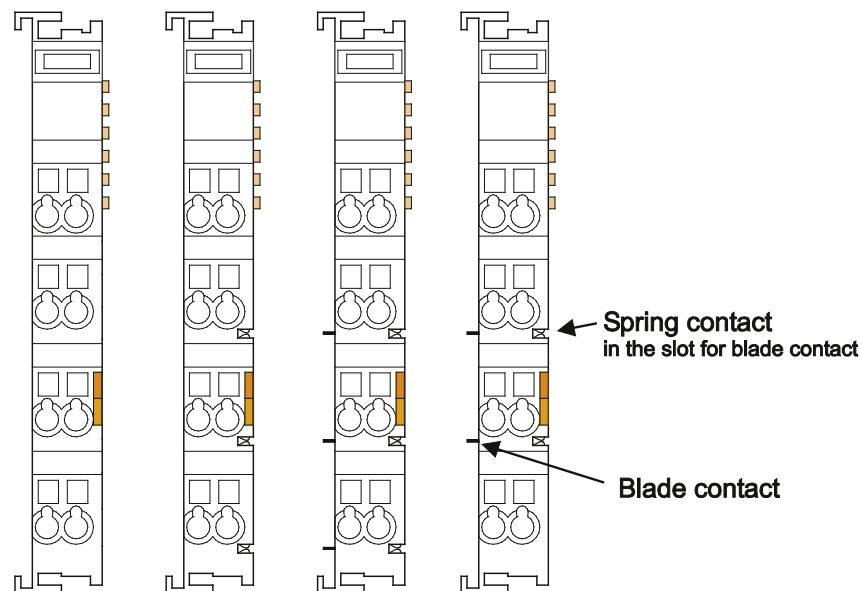

Figure 36: Example for the arrangement of power contacts

Note



Field bus node configuration and test via smartDESIGNER

With the WAGO ProServe® Software smartDESIGNER, you can configure the structure of a field bus node. You can test the configuration via the integrated accuracy check.

6.3 Connecting a Conductor to the CAGE CLAMP®

The WAGO CAGE CLAMP® connection is appropriate for solid, stranded and finely stranded conductors.

Note



Only connect one conductor to each CAGE CLAMP®!

Only one conductor may be connected to each CAGE CLAMP®.

Do not connect more than one conductor at one single connection!

If more than one conductor must be routed to one connection, these must be connected in an up-circuit wiring assembly, for example using WAGO feed-through terminals.

Exception:

If it is unavoidable to jointly connect 2 conductors, then you must use a ferrule to join the wires together. The following ferrules can be used:

Length:	8 mm
Nominal cross section _{max.} :	1 mm ² for 2 conductors with 0.5 mm ² each
WAGO product:	216-103 or products with comparable properties

1. For opening the CAGE CLAMP® insert the actuating tool into the opening above the connection.
2. Insert the conductor into the corresponding connection opening.
3. For closing the CAGE CLAMP® simply remove the tool. The conductor is now clamped firmly in place.

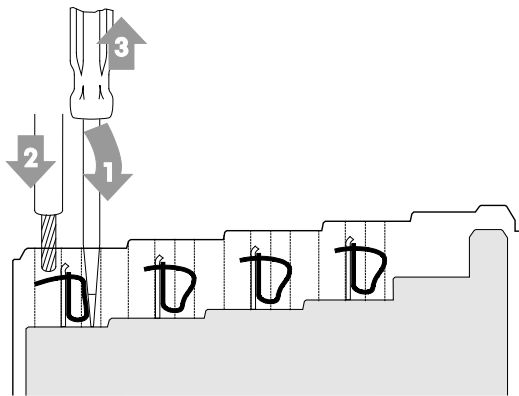

Figure 37: Connecting a conductor to a CAGE CLAMP®

7 Function Description

This chapter describes the essential functions of the fieldbus coupler.

- Device start-up and initialization
- Switch port settings
- Identification and maintenance data sets (I&M)
- Process data structure
- Configuration limits
- Flexible configuration of digital I/O modules
- Variation of physical peripheral layout
- Sharing I/O modules in several ARs (Shared Device)
- Use of failsafe I/O modules (PROFIsafe V2)
- Individual parameterization of I/O modules using iPar-Server
- Control of digital and analog output modules by means of PROFIenergy
- Firmware Update

7.1 Device Start-Up and Initialization

After a restart the fieldbus coupler does several hardware tests, e.g. the check of memory components. Successfully passed those tests it initializes the internal communication system K-Bus to identify the arranged I/O modules and to exchange information with them. This phase is indicated by the I/O LED, which flashes red at 10 Hz. Subsequent to the successful K-Bus initialization the I/O-LED changes to green on-state.

The fieldbus coupler then switches to the "Fieldbus Start" state in which it waits for the connection with the higher-level control system (IO controller) as an IO device.

If an error occurs during start-up, the I/O LED flashes red and a blink code indicates the respective error message.

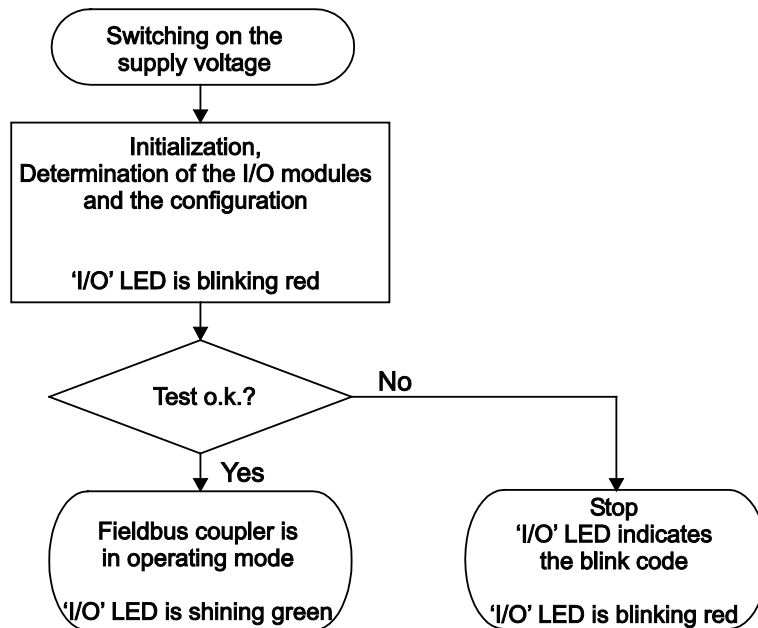

Figure 38: Fieldbus coupler operating system



Information

More information about the LED Signaling

Read the detailed description for the evaluation of the displayed LED state in the section “Diagnostics” > “LED Signaling”.

7.2 Switch Port Settings

You have the option of using the two ports of the fieldbus coupler in the following connection settings:

- Auto-Negotiation (default)
- 100 MBit/s full-duplex, Auto-Negotiation
- 100 MBit/s full-duplex
- deactivated

The port settings are made as part of the configuration and applied to the fieldbus coupler via standardized data sets. The settings are stored in non-volatile memory.

7.3 Identification and Maintenance Data Sets (I&M)

The I&M data sets are used in PROFINET IO for unique identification of a device in the plant.

I&M 0 provides basic information about the manufacturer, revision level and properties of the device. This data set is readable only.

Data sets I&M 1-4 contain system-specific information. These data sets can be described individually for you, e.g. to specify the function of the field device in the installation environment.

The table below describes the structure of the data sets, as well as the content and its meaning.

Table 31: Identification and Maintenance Data Sets (I&M)

Data set	Index	Access	Content	Description
I&M 0	0xAFF0	Read	Order ID MAC Address Hardware Revision Software Revision Device Type (25 characters) Vendor ID I&M Support	Default basic information about the device.
I&M 1	0xAFF1	Read and Write	Device Function (32 characters) Device Location (22 characters)	Description of the function of the device and its location of use
I&M 2	0xAFF2		Installation Date (16 characters)	Installation data of the field device in the system
I&M 3	0xAFF3		Description (54 characters)	Individual short description of the field device
I&M 4	0xAFF4		Signature (54 characters)	Security attribute, e.g. for verification of a specific parameterization

Information



More information on the I&M data sets!

More information on the I&M data sets is available in the appendix in chapter “Detailed Structures of I&M 0-4”.

7.4 Process Data Architecture

7.4.1 Basic Structure

A node can consist of a mixed arrangement of analog and digital, system and special function modules.

For the configuration only I/O modules are taken into account, which exchange process data on the internal bus (K-Bus) with the fieldbus coupler (data width or bit width greater than 0).

The input and output process images which are exchanged with the respective IOC using real time frames are only available on a successful connection establishment to the particular IOC.

Information



Additional Information

For the number of input and output bits or bytes of the individual I/O modules, refer to the corresponding description of the I/O modules.

For the local input and output process data image, the data of the configured I/O modules is stored in the order of its position next to the fieldbus coupler in the respective process image.

The size of the process image is determined by the configuration data of the fieldbus coupler and of the I/O modules connected to it.

If the maximum size is exceeded in the respective process image, an error message appears in the configuration software being used.

The process image is limited to 512 bytes of input or output data. Thus, up to 250 I/O modules can be connected to the fieldbus coupler until the process image reaches a maximum size of 512 bytes in the input and/or in the output direction.

Information



More information on configuration limits!

For additional information to the configuration limits refer to "Configuration limits" chapter.

7.4.1.1 Allocation of the Input and Output Data

The process data is exchanged via the PROFINET IO using the higher-level controller (IO controller).

The output data including all process data qualifiers (IOPS and IOCS) is transferred cyclically from the IO controller to the fieldbus coupler. The fieldbus coupler sends the input data including all process data qualifiers (IOPS and IOCS) cyclically to the IO controller.

When configuring the fieldbus node, the individual I/O modules are configured in accordance with their physical arrangement (slot-oriented).

These can be found as part of the configuration based on individual requirements in the hardware catalog of the configuration software. All specific information on the relevant I/O modules is contained in the associated GSD file.

Information **More Information on module-type allocation of the I/O modules!**



Allocation of the I/O modules for the different module types and selectable submodule types is listed in the appendix. A tabular listing contains the chapter "Module and submodule Types of the I/O Modules".

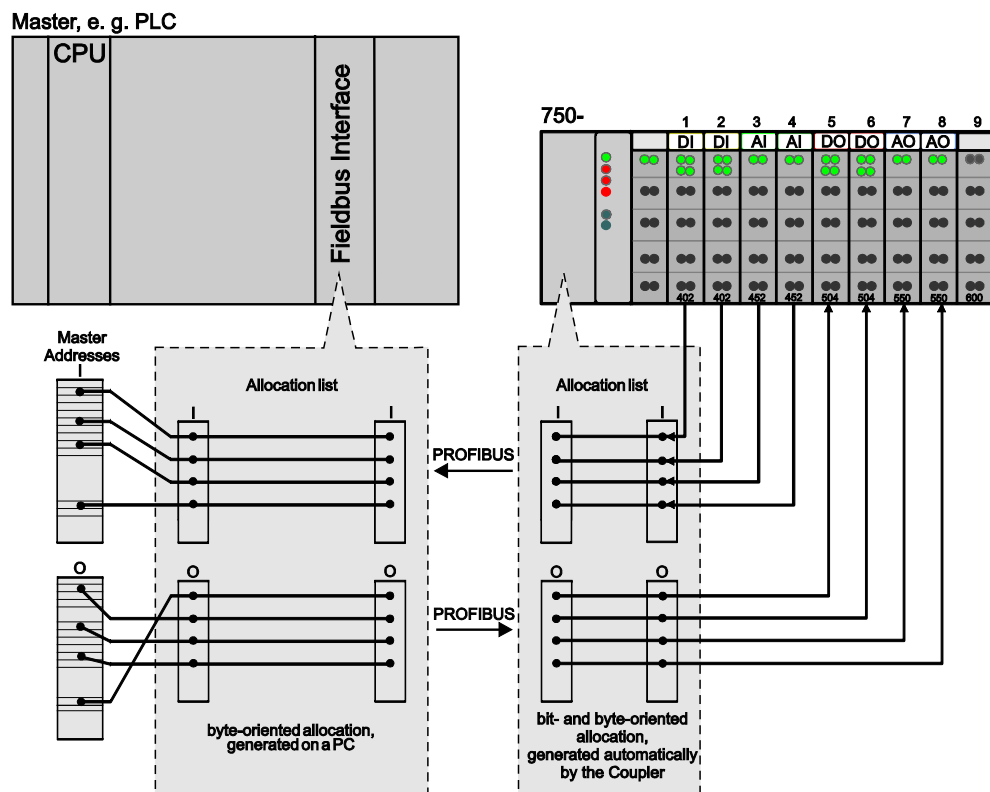

Figure 39: Allocation of the Input and Output Data

In productive data exchange, one or two byte IOXS process data qualifiers are available for each configured module providing information on the validity of the submodule data. The process data qualifiers are an integral part of the maximum length of the telegram with the provider and consumer data and must therefore be considered when installing the modules.



Information

More information on process data qualifiers and configuration limits!

For additional information to the process data qualifiers refer to “Process Data Qualifiers in Telegrams for PROFINET IO” chapter. For additional information to the configuration limits refer to "Configuration limits" chapter.

7.4.2 Process Data Qualifiers in Telegrams for PROFINET IO

7.4.2.1 One Byte IOxS Process Data Qualifiers

In cyclic telegrams, one byte process data qualifiers each are available for PROFINET IO in the IO controller (IOPS) direction and in the IO device (IOCS) direction for submodule types carrying the input or output data.

The amount of data in the real-time telegrams is always one byte more than the respective process data length for these submodule types.

7.4.2.2 Two Byte IOxS Process Data Qualifiers

If the submodule types carry both input and output data, two byte process data qualifiers each are available in cyclic telegrams for PROFINET IO in the IO controller (IOxS) direction and in the IO device (IOxS) direction.

The amount of data in the telegram is always two bytes more than the respective process data length for these submodule types.

7.4.2.3 Examples of One and Two Byte IOxS Process Data Qualifiers

- **Example 1:**
Process data qualifiers for 2-channel digital input modules without diagnostics and with diagnostics and diagnostic acknowledgement.

Table 32: Example 1 for process data qualifiers for 2-channel digital input modules without diagnostics and with 1-bit diagnostics and diagnostic acknowledgement.

PNIO submodule type	Telegram direction																							
	IOD → IOC (Provider) (input data)												IOC → IOD (Consumer) (output data)											
	7	0	15	8	23	16	31	24	39	32	47	40	7	0	15	8	23	16	31	24	39	32	47	40
2DI (+ 6 BIT I)	IB0	IOPS										IOCS												
2DI (+14 BIT I)	IB0	IB1	IOPS									IOCS												
2DI (+30 BIT I)	IB0	IB1	IB2	IB3	IOPS							IOCS												
2DI (- 2 BIT E)	IOPS											IOCS												
2DI (+ 6 BIT I/O), DIA, Ackn.	IB0	IOPS	IOCS									OB0	IOPS	IOCS										
2DI (+14 BIT I/O), DIA, Ackn.	IB0	IB1	IOPS	IOCS								OB0	OB1	IOPS	IOCS									
2DI (+30 BIT I/O), DIA, Ackn.	IB0	IB1	IB2	IB3	IOPS	IOCS						OB0	OB1	OB2	OB3	IOPS	IOCS							
2DI (- 2 BIT I/O), DIA, Ackn.	IOPS											IOCS												

- Example 2:**
 Process data qualifiers for 2-channel digital output modules with diagnostics.

Table 33: Example 2 for process data qualifiers for 2-channel digital output modules with diagnostics

PNIO submodule type	Telegram direction																													
	IOD → IOC (Provider) (input data)												IOC → IOD (Consumer) (output data)																	
	7	0	15	8	23	16	31	24	39	32	47	40	7	0	15	8	23	16	31	24	39	32	47	40						
2DO (+ 6 BIT O)	IOCS												OB0 IOPS																	
2DO (+14 BIT O)	IOCS												OB0 OB1 IOPS																	
2DO (+30 BIT O)	IOCS												OB0 OB1 OB2 OB3 IOPS																	
2DO (- 2 BIT O)	IOPS												IOCS																	
2DO, 2DIA (+ 6 BIT I/O)	IB0			IOPS			IOCS			OB0 IOPS IOCS																				
2DO, 2DIA (+14 BIT I/O)	IB0			IB1			IOPS			IOCS			OB0 OB1 IOPS IOCS																	
2DO, 2DIA (+30 BIT I/O)	IB0			IB1			IB2			IB3			IOPS			IOCS			OB0 OB1 OB2 OB3 IOPS IOCS											
2DO, 2DIA (- 2 BIT I/O)	IOPS												IOCS																	

- Example 3:**
 Process data qualifiers for 2-channel analog input and output modules.

Table 34: Example 3 for process data qualifiers for 2-channel analog input and output modules

PNIO submodule type	Telegram direction																																															
	IOD → IOC (Provider) (input data)																IOC → IOD (Consumer) (output data)																															
	7	0	15	8	23	16	31	24	39	32	47	40	55	48	63	56	7	0	15	8	23	16	31	24	39	32	47	40	55	48	63	56																
INT16[2] I	IW0				IW1				IOPS				IOCS																																			
INT16[2] O	IOPS																OW0				OW1				IOCS																							
{UINT8, INT16}[2] I/O	SB0				IW0				SB1				IW1				IOPS				IOCS				CB0				OW0				CB1				OW1				IOPS				IOCS			

- Example 4:**
 Process data qualifier for special-purpose modules, e.g. SSI sensor interface.

Table 35: Example 4 for process data qualifiers for special-purpose modules, SSI sensor interface

PNIO submodule type	Telegram direction																																							
	IOD → IOC (Provider) (input data)																IOC → IOD (Consumer) (output data)																							
	7	0	15	8	23	16	31	24	39	32	47	40	55	48	63	56	7	0	15	8	23	16	31	24	39	32	47	40	55	48	63	56								
UINT32 I	ID0																IOPS																							
{UINT8, UINT8, UINT32} I/O	SB0				RES				ID0				IOPS				IOCS				CB0				RES				OD0				IOPS				IOCS			

7.5 Configuration Limits

7.5.1 Minimum Configuration

The minimum configuration is used when you only configure the station proxy (DAP).

In this case, the application does not include any user data. The length of the application data is zero.

The provider telegram contains the provider status of the submodules for Interface, Port 1, Port 2 and station proxy (DAP). The provider telegram length is 64 bytes.

The consumer telegram contains the consumer status of the submodules for Interface, Port 1, Port 2 and station proxy (DAP). The consumer telegram length is also 64 bytes.

7.5.2 Maximum Configuration

Due to one of the following boundary conditions, you can achieve the maximum configuration:

- Maximum of 250 modules or submodules
- Maximum input data length of 512 bytes configured
- Maximum output data length of 512 bytes configured
- Maximum provider data length of 736 bytes in the real time telegram exhausted
- Maximum consumer data length of 736 bytes in the real time telegram exhausted

7.6 Flexible Configuration of Digital I/O Modules

7.6.1 Packaging Information from Digital Input and Output Modules

Digital input modules and/or digital output modules occupy a data volume of 1 or 2 bits per channel in the process image. Depending on the number of channels, the scope of the process data of the respective I/O modules ranges from 2 bits to 2 bytes.

Data management of processing systems such as PCs or controllers is normally byte-, word- or double word-oriented.

To ensure processing on these systems is as efficient as possible, you can flexibly arrange process data from digital input modules and digital output modules in byte, word or double word data structures. This can be accomplished by using corresponding submodule types in the configuration:

- Submodule types that allocate data (in byte, word or double word sizes)
- Submodule types that do not allocate any data (whose information is classified in previously allocated data ranges)

Submodule types that allocate data

To map process data from digital input and output modules to larger data structures, you can select submodule types that allocate a corresponding number of additional bits for each digital I/O module in addition to the data volume of the physical channels, so that you achieve the required data structure size.

Submodule types for allocation of 8, 16 or 32 bits are available to you.

The name of the allocating submodule types contains the "+" character plus the remaining available number of bits of the process input and/or output data.

Example:

The "2DE, 2DIA (+14 BIT I/O)" submodule type is suitable for a module with 2 digital inputs with diagnostics capability and each one bit diagnostic acknowledgement per channel in the output image, whose data should be processed with the data of subsequent digital input and/or output modules in a 16-bit structure in the input and output data area. Up to 14 bits of input and output information can be allocated with the processed data of the submodule types described below.

Submodule types that allocate no data

If data volumes larger than actually required to represent the physical channels are always used for digital I/O modules, data processing is very inefficient as data without any actual information also has to be transmitted.

For subsequent use of additional allocated areas, submodule types are available that occupy this process data and allocate no data area themselves.

The name of these submodule types contains the "-" character plus the quantity of information used by the submodule.

Example:

The "4DE (-4 BIT I)" submodule type allocates no new data area and is suitable for a module with 4 digital inputs, whose data should be assigned an input data area previously allocated.

You can efficiently "package" the process data of digital inputs/outputs by using both allocating and non-allocating submodule types.

Information



More information on the module and submodule types!

The appendix contains a list of module types with possible submodule types and assignment of the respective I/O modules with information about data values in the chapter "Module and Submodule Types of the I/O Modules".

7.6.1.1 Rules for Packaging Digital Information

Only allocated data can be processed.

If a submodule type allocates more data than immediately required, the surplus data volume can be occupied by submodule types that allocate no data. The data volume of these submodule types, however, cannot be greater than that previously allocated.

The following rules apply for allocating and occupying data:

- Assignment is separate for inputs and outputs.
- The assignment takes the order into account.
I/O modules, for which non-allocating submodule types have been configured, can only occupy data previously made available by an allocating submodule.
- Assignment is section by section.
Once another I/O module is configured, whose submodule type allocates input and/or output data, a new section begins. I/O modules with non-allocating submodule types can only occupy data in the last allocating section. The allocated data in preceding sections cannot be used retroactively.
- When assigning, only I/O modules with digital input and output data are taken into account.
I/O modules with analog input/output data are ignored even when physically between the digital input/output data according to the configuration.
- When assigning, I/O modules are ignored, for which an incorrect submodule type has been configured, i.e. for which the submodule type does not match the I/O module physically inserted.

Allocated areas that are not occupied are handled as followed by the fieldbus coupler:

- Output data that has been allocated, but not occupied, is ignored by the fieldbus coupler (DAP).
- Input data that has been allocated, but not occupied, is set to zero ("false") by the fieldbus coupler (DAP).

7.6.1.2 Example of Packaging Digital Information

In addition to the fieldbus coupler (DAP), a station consists of the following I/O modules in the order shown:

Table 36: Example for a station with the following selected submodules

Slot	Module	Submodule
0	Fieldbus coupler PROFINET IO	
1	75x-401 2DI	2DI (+ 14 BIT I)
2	75x-504 (/0..-...) 4DO	4DO (+ 12 BIT O)
3	75x-550 2AO, 0-10V	INT16[4] O
4	75x-530 (/0..-...) 8DO	8DO (- 8 BIT O)
5	75x-403 4DI	4DI (- 4 BIT I)
6	75x-501(/0..-...) 2DO	2DO (+ 6 BIT O)

The digital submodule at slot 1 allocates a total of 2 bytes in the input process image and occupies 2 bits of that.

The digital submodule at slot 2 allocates a total of 2 bytes in the output process image and occupies 4 bits of that.

There is an analog output submodule at slot 3 that plays no role in packaging digital I/O modules.

The digital submodule at slot 4 requires 8 bits that are included in the output data area allocated from slot 2. 4 bits of slot 2 are still available for additional output data.

The digital submodule at slot 5 requires 4 bits that are included in the input data area allocated by slot 1. 10 bits are still available from slot 1 for additional input data.

The digital submodule at slot 6 allocates an additional output data area of 1 byte. The area of slot 2 is closed and remains unused. The free bits do not reach the peripherals.

The figures below show the packaged user data in the real-time PROFINET IO telegram each in the output and input direction.

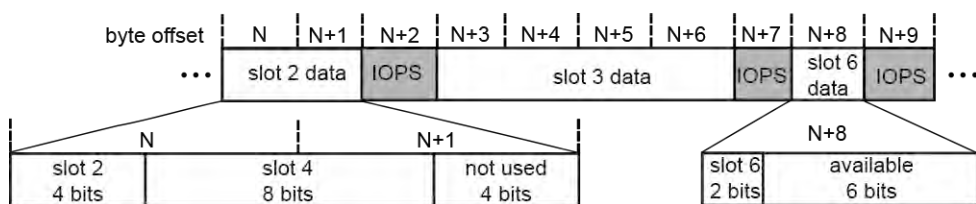

Figure 40: Output process data in the frame IOC → IOD

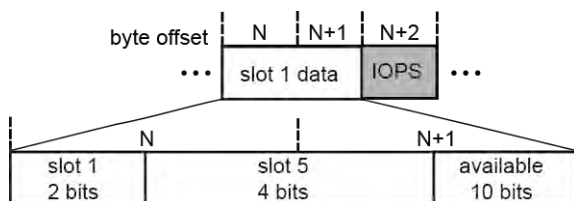

Figure 41: Input process data in the frame IOD → IOC

7.6.1.3 Possible Errors when Packaging Digital Information

When connecting ("Connect"), the fieldbus coupler checks the configuration of the connected I/O modules. Identified violations of the configuration rules are reported to you in the form of module differences ("ModuleDiffBlock").

Process image optimization of digital information leads to module differences in the following cases:

- Configuration of incorrect submodule types, i.e. one or more submodule types does not match the I/O modules physically inserted. The module status of the affected module slots is listed as "substitute", the submodule status as "wrong".
- In one or more sections, the data volume provided by the configured allocating submodule types is inadequate to meet the requirement for process data of the following non-allocating submodule types. For these modules, the module status "proper module" and submodule status "wrong" are entered.

Example of module differences:

A section consists of 6 modules.

The first submodule allocates 16 bits and of that occupies 2 bits. 14 bits are still available.

The subsequent 5 submodules do not allocate and each requires 4 bits.

The second, third and fourth submodule can occupy the required data volume of 4 bits each, i.e. 12 bits.

For the fifth submodule, only 2 bits are available. The fifth module is marked as wrong the data is not fully allocated.

Because there was not already enough information available for the preceding module and the allocated area has been declared as "exhausted" by the fieldbus coupler, no allocated area is available for the sixth submodule. This module is also marked as wrong.

7.7 Variation of physical peripheral layout

The usage of active spacer modules bearing the item numbers 753-1629 and/or 753-1629/000-001 at PROFINET IO advanced fieldbus coupler 750-375 as of firmware V2.1.x (03) enables the physical I/O module arrangement to be varied within a defined maximum configuration. The rearrangement of the maximum configuration will be implicitly enabled by the presence of at least one of the above mentioned active spacer modules. The fieldbus coupler thus performs an extenuated configuration check which offers following options concerning node assembly to you:

- Representation of actually not used I/O modules by an active spacer module each as part of the maximum configuration inside the node (physical option modules)
- Omission of any I/O module as part of the maximum configuration at the end of the node, i.e. just located before the end module (virtual option modules)

7.7.1 Exemplary Maximum Configuration

The following figure illustrates an exemplary maximum configuration for the fieldbus coupler 750-375.

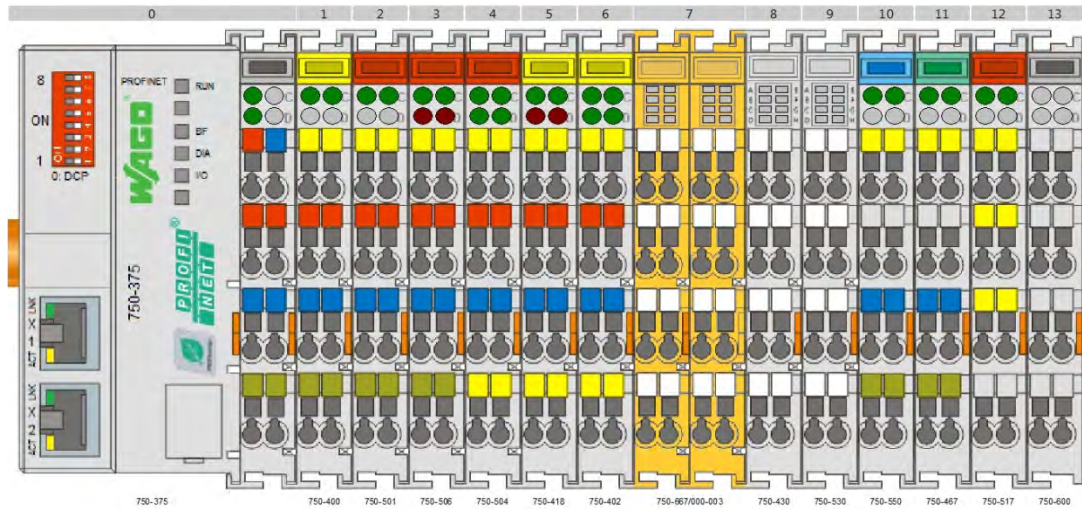

Figure 42: Exemplary maximum configuration

7.7.1.1 Physical Option Modules

Physical option modules are usually represented by active spacer modules. For the following node, which is rearranged within the maximum configuration, the 2-channel digital output module 750-501 at slot 2, the 4-channel digital output module 750-504 at slot 4 and the 2-channel digital input module 750-418 at slot 5 are obsolete. The I/O modules are located inside the node, i.e. not directly arranged before the end module. Therefore they have to be represented by an active spacer module each.

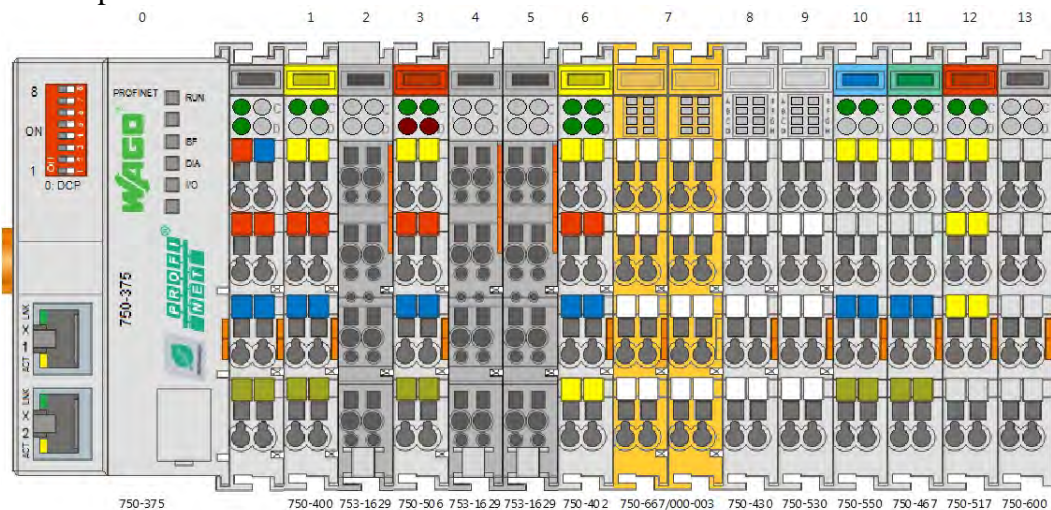

Figure 43: Exemplary usage of physical option modules

7.7.1.2 Virtual Option Modules

Are there obsolete I/O modules in a configuration variation, which are located next to the end module, they can be omitted if at least one active spacer module is part of the arrangement. In this use case the 2-channel analog output module 750-550 at slot 10, the 2-channel analog input module 750-467 at slot 11 as well as the 2-channel relay output module 750-517 at slot 12 are not required. To enable the extenuated configuration check of the fieldbus coupler the I/O module at slot 10 has to be represented by an active spacer module. The I/O modules located at slot 11 and 12 can be omitted and are processed as virtual.

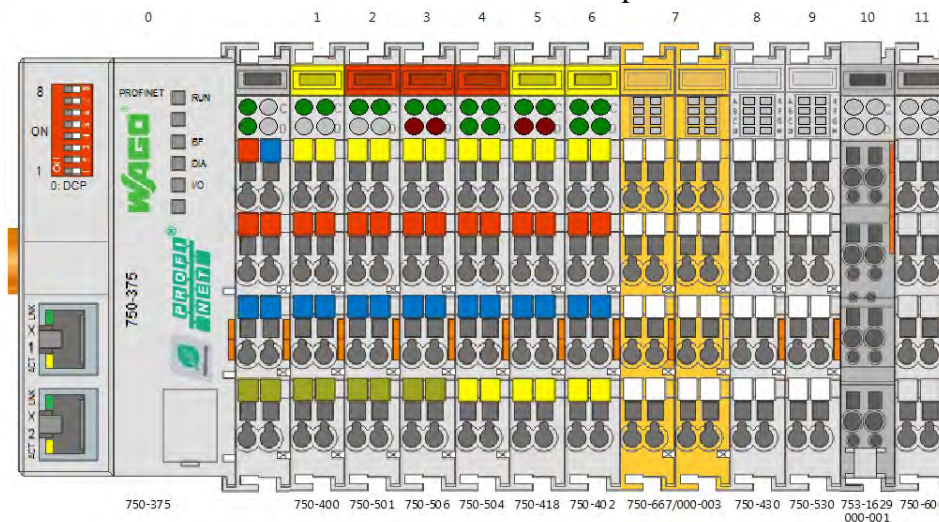

Figure 44: Exemplary usage of virtual option modules

7.7.1.3 Combination of Physical and Virtual Option Modules

This use case excludes the PROFIsafe V2 module 750-662/000-003 at slot 7 and the 2-channel relay output module 750-517 at slot 12. The PROFIsafe V2 module is represented by a physical option module. The I/O module at slot 12 can be considered as virtual and thus be omitted because it is located next to the end module and the extenuated configuration check is already enabled by the active spacer module at slot 7.

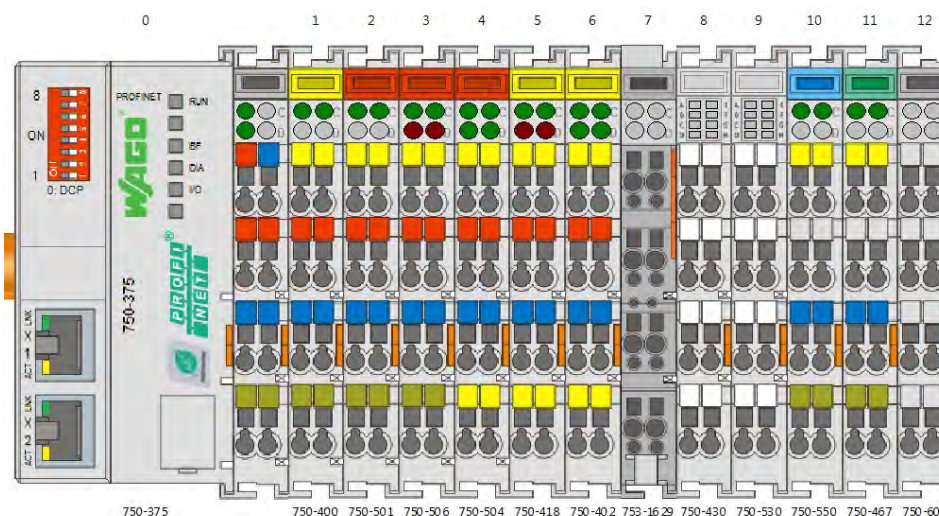

Figure 45: Usage of option module without physical slot reservation

Should it be possible to replace the physical option module at slot 7 by the real PROFIsafe V2 module, it is recommended to bypass the missing slot space of 12 mm using a passive spacer module 753-629/020-000. Thus an optional later use of the PROFIsafe V2 module without shifting the succeeding I/O modules by 12 mm is ensured. To reserve the slot 12 physical as an option, the above mentioned passive spacer module can be plugged again.

The resulting station layout is shown in the following figure.

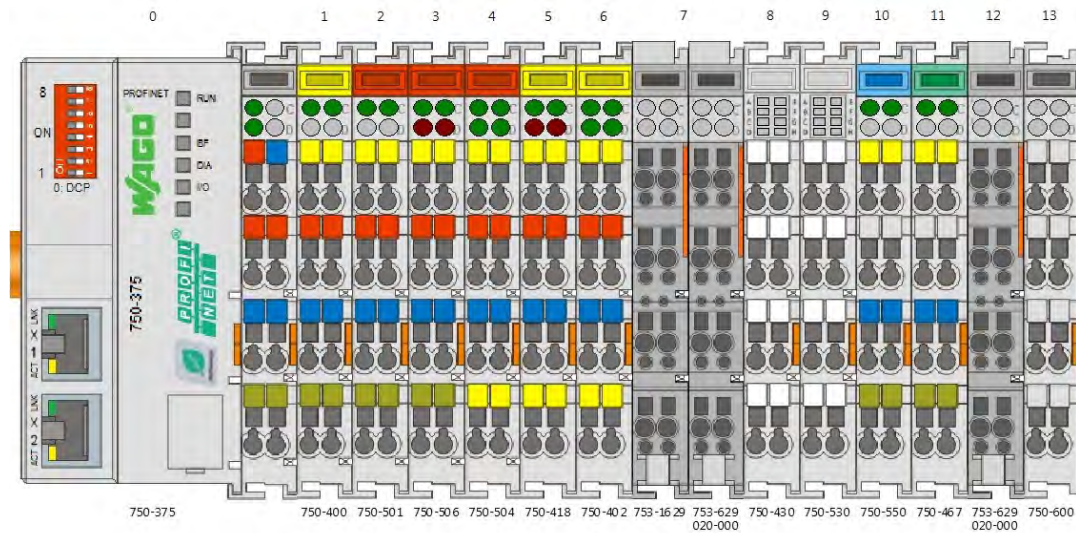

Figure 46: Usage of option module with physical slot reservation

7.7.2 Station Characteristics using Option Modules

7.7.2.1 Connection Phase

There are significant differences in checking real against expected configuration during connection establishment to an IO device comprising optional modules.

The option modules assume the identity of the configured I/O module at the particular slot. Thus no module difference is notified for a slot containing an active spacer module. Even a change of the expected configuration doesn't result in module differences during configuration check.

Are there more configured I/O modules than physically plugged, the missing I/O modules can be virtually appended. Such virtual option modules don't cause module differences to be notified by the fieldbus coupler, even if a reconfiguration in the section of virtual option modules is initiated and the connection is established again.

The non-option modules plugged are checked against the expected configuration as usual. Any module differences are reported to the IO controller during connection establishment.

7.7.2.2 Process Data Handling

The handling concerning the PROFINET IO process data is the same for physical and virtual option modules:

- The input data of the represented I/O module provided to the IO controller is set to zero.
- The output data provided to the represented I/O module by the IO controller is filtered by the fieldbus coupler.

The PROFINET IO provider or consumer states (IOXS) are controlled depended to the K-Bus state and the access right of the AR to the particular I/O module. This corresponds to the behavior of non-option modules.

7.7.2.3 Identification

PROFINET IO offers the opportunity to request the real configuration of an IO device independent to an established IOxAR.

In general, option modules are represented by the ModuleIdentifier 0x00008404. The distinction between physical and virtual option modules is done by the SubmoduleIdentifier

If there is no IOxAR established after restart of the station, the data set „RealIdentificationData“ delivers the ModuleIdentifier 0x00008404 and the SubmoduleIdentifier 0x01000000 for slots mounted with physical option modules. There are no virtual option modules available in this operating state.

Is an IOxAR already established to the station the data set „RealIdentificationData“ delivers the ModuleIdentifier and the SubmoduleIdentifier of the represented I/O module for an option module slot. For option modules which are not owned by the established IOxAR, the ModuleIdentifier 0x00008404 and the appropriate SubmoduleIdentifier is registered within data set.

The table below shows the delivered ModuleIdentifier or SubmoduleIdentifier for option modules in dependence to the current operating state of the station.

Tabelle 37: Real identification of option module slots

Option Module Type	IOC Access	ModuleIdentifier	SubmoduleIdentifier
Physical	No	0x00008404	0x01000000
	Yes	Corresponds to the configured module	Corresponds to the configured submodule
Virtual	No	0x00008404	0x02000000
	Yes	Corresponds to the configured module	Corresponds to the configured submodule

7.7.2.4 I&M Data Sets

For non-option modules which bear its own I&M data and are represented by physical or virtual option modules, I&M data of the station proxy is delivered.

7.7.2.5 Diagnostics

In case an option module represents an I/O module with diagnostics no notifications will be sent to the IO controller, even if the channel diagnosis is enabled.

For option modules there are no flash sequences concerning an error indicated on the IO-LED of the fieldbus coupler.

7.8 I/O Module Distribution to Several ARs (Shared Device)

The fieldbus coupler can exchange productive data with up to two IO controllers (IOCs) and one IO supervisor (IOS) simultaneously.

When establishing more than one AR, all existing I/O modules must **only** be assigned to one of the IOCs involved. The exact procedure for how this unique assignment is made depends on the used IOC configuration environment.

If an I/O module is inadvertently assigned to multiple IOCs when using independent IOC configurations, only one IOC has access authorization. Access depends on the start-up behavior of the IOCs uses and the entire system. That IOC obtains access authorization, which establishes the first AR to the fieldbus coupler in which the respective submodule was configured.

IOCs whose connection is then established and that also request access to the submodule previously assigned get a message from the fieldbus coupler about the presence of a "ModuleDiffBlock" in the "Connect Response". This indicates that the submodule has already been subscribed to by another IOC ("Locked by IO controller") and that access to the configured submodule is denied.

Reparameterization of the submodule with other settings if necessary is thus avoided.

In the process data qualifiers of the connections that do not have the incorrectly configured submodule, the subsequent cyclic productive data exchange indicates that the process data is not valid (IOXS = BAD).

Once the AR that currently has access authorization to a submodule with multiple assignments is released, another connected IOC is getting access per "Release Alarm" if it also requested claim to the submodule in the connection phase. The IOC then referred to as the subscriber can exchange valid process data with the submodule after successful re-parameterization.

7.9 Using Fail-Safe I/O Modules (PROFIsafe V2)

The fieldbus coupler allows you to operate all PROFIsafe V2 I/O modules of the 750 and 753 series with the respective item number extension ".../000-003". This extension indicates that it is a 3rd generation PROFIsafe I/O module.

You can activate diagnostics channel-by-channel using the fieldbus coupler 750-375. Module diagnostics, e.g. F parameterization error or iPar client message, are activated globally.

The submodules of the PROFIsafe V2 I/O modules allow storage of module-specific parameters, i.e., safety-related parameters (iParameters) on an available iPar server of the higher-level control.

That is a significant advantage when a module has to be replaced. Initially, the I/O module just installed has the default settings. The previously saved individual parameterization is automatically set via the non-secure functionality of the respective iPar server function block. This ensures that productive data exchange can be included again immediately after the exchange.

In the event that no iPar server is available or you want to operate the PROFIsafe V2 I/O modules using the factory default parameterization ("out of the box"), the "F_iPar_CRC" of the submodules are already preset with values in the GSD file. These values correspond to those of the factory settings. Use of the WAGO-SEDI is thus not required.

Information



More Information on the PROFIsafe V2 I/O modules!

More information on the PROFIsafe V2 I/O modules is available in the respective manuals of the PROFIsafe safety modules of the 750 and 752 series. You can download these manuals free of charge from the WAGO Internet site at:

www.wago.com.

7.10 Individual Parameterization of I/O Modules via iPar Server

The iPar server provides services for saving and restoring iParameters for quick device replacement without using additional manufacturer tools for parameterization of device functions.

The iPar server is a function block or available as a system function within the non-safety related part of the safe PLC.

Currently, you can only use the iPar server mechanisms with the PROFIsafe V2 I/O modules.

To parameterize device functions of these I/O modules, the iParameters are used that have to be set at start-up using a manufacturer tool due to the current definitions.

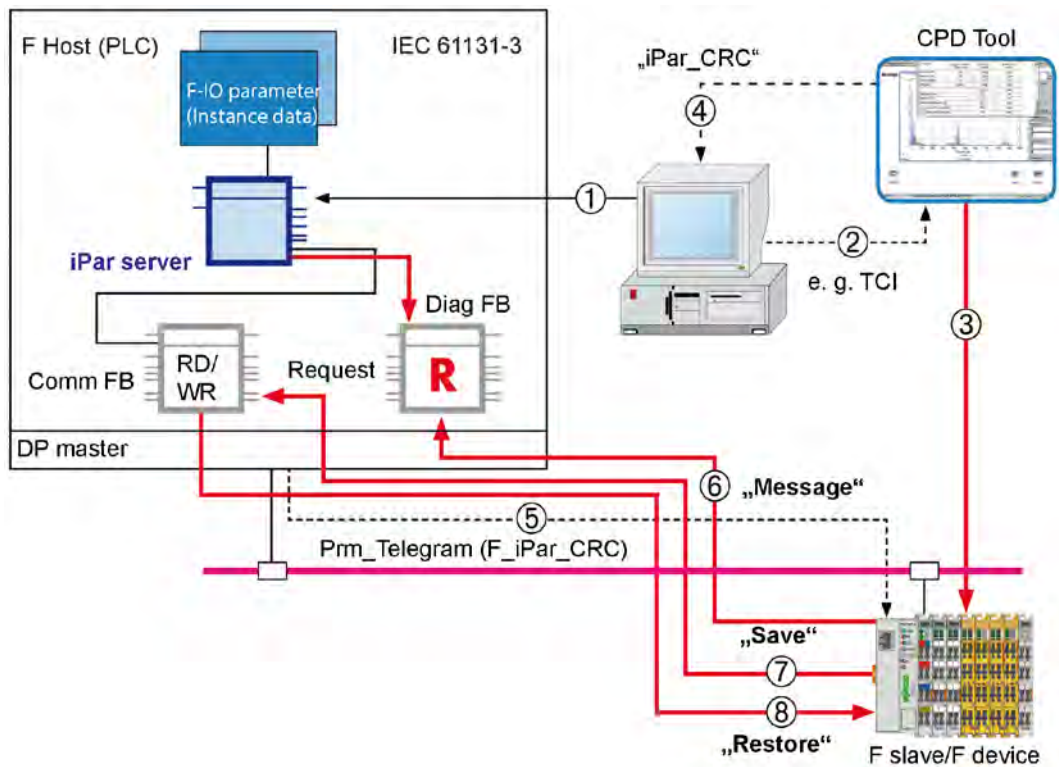

Figure 47: iPar Server

Table 38: Legend for the iPar server figure

No.	Explanation
1	Instantiation of the "iPar Server" function
2	CDP Tool Start and parameter transfer (e.g., node address)
3	iParameterization and start-up, test and release
4	Transfer of iParameter backup (signature) to the host
5	During start-up, transfer of the signature to F-slave (Prm_Telegram)
6	Message to iPar server about diagnostic agent (alarm/status)
7	iPar server polls the diagnostic function block (Diag-FB) and starts "Save" if required
8	iPar server polls the diagnostic function block (Diag-FB) and starts "Restore" if required

The WAGO parameterization tool WAGO-SEDI is used for fail-safe parameterization and can be executed from the configuration environment of the IOCs used. To call up SEDI, three different communication paths are available that correspond to the TCI conformance classes:

- 1 Local configuration interface (TCI CC1)
The SEDI is called up via *WAGO-I/O-CHECK*.
- 2 TCP/IP communication via WAGO service port 6626 (TCI CC2)
The SEDI is called up via *WAGO-I/O-CHECK*.

- 3 IOS connection (TCI CC3)
The SEDI is called up directly via the communication server of the configuration environment.

Information



More Information on the TCI conformance classes!

More information on the TCI conformance classes is available in the quickstart guide of the PROFINET IO fieldbus coupler. You can download the quickstart guide free of charge from the WAGO Internet site at: www.wago.com.

Information



More Information on the iPar server!

More information on the iPar server is available in the manuals for PROFIsafe safety modules of the 750 and 753 series. You can download these manuals free of charge from the WAGO Internet site at: www.wago.com.

7.11 Controlling Digital and Analog Output Modules per PROFIenergy

PROFIenergy is an energy management profile based on the communication mechanisms of PROFINET IO.

Encouraged by the Automation Initiative of German Automobile Manufacturers (AIDA), a specification was developed by PROFIBUS & PROFINET International and standardized in the form of a general profile.

The PROFIenergy implementation of the fieldbus coupler is based on profile version 1.0.

PROFIenergy devices can be switched between predefined energy saving modes using standardized commands. The switching characteristics do not fall to the specification, but are manufacturer specific.

7.11.1 Hardware

The concept of the energy saving measures is based on PROFIenergy-specific substitute values of the digital and analog output modules available to you when using the respective PROFIenergy submodule for the configuration. These submodules are marked with "PE" in the designation. You can configure the PROFIenergy substitute values within the framework of the available output value range. Currently, parameterization of one PROFIenergy substitute value per signal channel is possible.

7.11.2 Functions

The fieldbus coupler supports the following PROFIenergy commands:

- Control commands
 - PE_Start_Pause
 - PE_End_Pause
- Status commands:
 - PE_List_Energy_Saving_Modes
 - PE_Get_Mode
 - PE_PEM_Status
 - PE_Identify

The functionality of the PROFIenergy protocol can only be described using control commands.

Each PROFIenergy submodule has a configurable minimum pause time after which it should switch from the application to the PROFIenergy "Pause" state, i.e. outputs the configured PROFIenergy substitute values.

If a PROFIenergy submodule receives the "*PE_Start_Pause*" command with the required pause time as a parameter, the required pause time and configured minimum pause time of the PROFIenergy submodule are compared.

If the required pause time is greater than or equal to the minimum pause time of the addressed PROFIenergy submodule, the energy-saving PROFIenergy substitute values are applied.

The PROFIenergy submodules do not exit the PROFIenergy "Pause" state independently. The operational state is only activated upon receipt of the "*PE_End_Pause*" control command.

The status commands provide information on the current state of the PROFIenergy submodule or its supported PROFIenergy commands.

7.11.3 Addressing

You can control the PROFIenergy submodules either separately via the respective submodule slot or together via submodule slot 1 of the fieldbus coupler.

In the first case, you configure the standard DAP and the PROFIenergy settings apply that you made on the part of the configured PROFIenergy submodules. In this configuration, only the configured PROFIenergy submodules of the respective digital and analog output modules can be reached via the PROFIenergy profile. Standard DAP submodule 1 is inaccessible.

In the second case, you use the PROFIenergy DAP of the fieldbus coupler. Only the minimum pause time of the PROFIenergy DAP submodule is relevant for initiating the pause state. The minimum pause times of the above mentioned I/O modules have no relevance in this operating situation. Access is limited to PROFIenergy DAP submodule 1 accordingly.

If the pause time requested per the *"PE_start_pause"* control command is greater than or equal to the configured minimum pause time of the PROFIenergy DAP, all configured PROFIenergy submodules are moved to the "Pause" state.

Since the DAP submodule of the fieldbus coupler can only be connected to one IO controller, control of PROFIenergy submodules is always submodule based via the connection to a second IO controller without access to the DAP submodule. Control of the PROFIenergy submodules is station-wide or submodule based depending on the DAP selected via the connection to the first IO controller. Parallel initiation of PROFIenergy commands via the DAP and the respective submodules within a connection (AR) is not possible.

7.12 Firmware Update

The device firmware is updated via the ETHERNET interface only and has to be carried out using the "WAGO Ethernet Update" firmware update tool.



Note

Firmware update tool only available on request!

Please note that the "WAGO Ethernet Update" firmware update tool is only available on request. Contact Technical Support by e-mail at: support@wago.com.

The steps required to update the firmware are explained in the "WAGO Ethernet Update" online help.

The following requirements must be met to successfully update the firmware:

- TCP port 6626 is available for the WAGO Service interface.

TCP port 6626 is enabled by default after each restart of the fieldbus coupler. It can only be temporarily disabled for PROFINET IO via parameterization of the station proxy (DAP).

- The fieldbus coupler has a valid device name.

The device name can be specified using a DCP service tool or via available DIP switch.

- The fieldbus coupler has appropriate IP settings.

A DCP service tool can be used to make the IP settings or temporarily using the address resolution of the connected IOX.

- The IP settings remain after restarting the fieldbus coupler as part of the firmware update or are made available again.

After the required firmware has been uploaded to the fieldbus coupler, it is checked for consistency and persistently stored. The firmware is applied by restarting via "WAGO Ethernet Update". The tool then attempts to initiate extraction of the internal file system for the web server. This requires that the IP settings used previously are available.

If the device name or IP settings are no longer available after restarting due to an only temporary assignment, they have to be reassigned to the fieldbus coupler using the procedures mentioned above to successfully complete the update process.

Note



Restart after loading invalid firmware!

Please note that inadvertently uploading invalid firmware or firmware not intended for the device leads to an error message in terms of the "WAGO Ethernet Update" and to error signaling on the 'I/O' LED of the fieldbus coupler. In such case, restart the fieldbus coupler.

The previous firmware version starts, thus allowing the user to try updating the firmware again.

Note



Impacts to MRP functionality (starting from FW 03) combined with FWL 03

Please note that firmware update to FW 03 combined with firmware loader FWL 03 installed on the device leads to following restriction. Startup of the device as part of an MRP ring causes IOC connection loss of other ring participants even if the connection monitoring is configured sufficiently (greater than 200 ms).

Should this issue impact your application in a negative way, return the fieldbus coupler for FWL upgrade to index 04 to WAGO.

8 Commissioning

8.1 General Procedure

If you have assembled the requested peripheral of the fieldbus coupler using the corresponding I/O modules and established the required power supply connections you can proceed with commissioning of the node within IOC engineering. The specific procedure depends on the configuration software used.

Therefore, this chapter does not describe the use of any specific application in terms of the configuration software. Instead, this chapter provides a brief overview of the process and steps required for commissioning.

Subsequent chapters provide the details of each step for commissioning.



Information

More Information on commissioning!

Specific step-by-step instructions are available in the quickstart guide for the PROFINET IO fieldbus coupler.

How an installed and connected fieldbus coupler is configured to the point that it is ready for use is described based on the configuration software.

You can download the quickstart guide from the WAGO Internet site at:
www.wago.com.

8.2 Procedure Description

To start the hardware configuration of the IO device you have first to import or to install the GSD file (see also chapter "GSD file") into the engineering software of the IOC. The GSD file contains all properties of the fieldbus coupler and the I/O modules to perform e.g. the configuration and parameterization of the IO device.

First, configure the fieldbus node that defines the structure of the process image for the input and output data.

The size of the process images is determined by the sum of all configured modules or submodules input and output data. The content of the process images is exchanged in productive data traffic with the IO controller.

To create the configuration data, transfer the physical structure of the station to the configuration software. The fieldbus coupler and each related I/O module are available in the hardware catalog of the configuration software as a module entry. For the various entries of the I/O module types, you can select different data representations in terms of submodule types for digital, analog and to a certain extend for complex I/O modules.

By specifically selecting suitable submodule types for the digital I/O modules, you have the option of optimizing the structure of the process images for the input and output data. The flexible configuration of the digital I/O modules is described in the section "Flexible Configuration of the I/O Modules".

For a station consisting of the fieldbus coupler and the connected I/O modules, arrange the I/O modules in the configuration software according to the physical slot.

The position and slot assignment of passive I/O modules that provide no data are not taken into account here.

If the configured arrangement differs from the physical arrangement, e.g. wrong modules or submodules or missing modules or submodules at the end of the fieldbus node, the fieldbus coupler reports the difference as an error.

The error is also indicated by the "DIA" LED.

Subsequent to the configuration of the IO device you have to do the parameterization of the fieldbus coupler as station proxy and the connected I/O modules where applicable.

As part of the parameterization, you can make specific settings for the attributes for each configured submodule that carries parameterization data.

Details about parameterization the station proxy and I/O modules, as well as parameter descriptions are available in the chapter "Parameterization".

Next you have to define the communication class, RT (RT_CLASS_1) or IRT (RT_CLASS_3), as well as the send clock and send cycle to be used at the interface submodule.

The communication class IRT is available to you starting from fieldbus coupler FW 03. Using IRT communication you have to define the sync domain and commit the network topology to the engineering software. Setup the physical connections of the ports at the port submodules of the IODs to be used and the IOC. The announcement of the network topology is also required if a toolless device replacement should be possible, i.e. without setting the station name by any software tool once again.

Thanks to the MRP functionality (starting from FW 03) the fieldbus coupler can be part of a redundant ring structure as MRP client. To use this operating mode activate the media redundancy role at the interface submodule and define the MRP domain. After saving the project you upload the configuration data to IOC.

8.3 Real Time Data Exchange Establishment

The IO controller assigns the configured IP address to the fieldbus coupler based on the station name assigned in advance. The PROFINET connection can then be established by the IO controller and the IO device can receive the configured parameters.

The fieldbus coupler then makes the respective parameter settings of the I/O modules.

After completing the parameterization phase, cyclic data exchange is initiated between the IO controller and IO device.

8.4 Perform configuration steps

The particular steps in configuration after complete installation of the IO device composed of the fieldbus coupler and the I/O modules are listed hereinafter:

1. Import or install the GSD file into the configuration environment (see also the chapter „GSD file“).
2. Generate an instance of the fieldbus coupler from hardware catalog into a previously opened project space for the particular IO controller.
3. Check and adjust the proposed device name or the assigned IP settings if necessary.
4. Proceed with the hardware configuration. Select thereby the I/O modules to be used from hardware catalog and adapt the I/O data representation by using the particular submodule if necessary (see also the chapter „Flexible Configuration of digital I/O Modules“).

5. Adapt the global station settings at the DAP submodule of the fieldbus coupler if necessary (see also the chapter „Parameterization of the Station Proxy (DAP).”)
6. Adapt the module or submodule parameterization of the configured I/O modules if necessary (see also the chapter „Parameterization of the I/O Modules”).
7. Select the communication class RT_CLASS_1 (RT) oder RT_CLASS_3 (IRT) at the interface submodule of the fieldbus coupler. In case of IRT the fieldbus coupler becomes SYNC slave. Using IRT operation adapt the name of the SYNC domain if necessary.
8. Check the update time or the send cycle and the monitoring time of the connection to the IO controller and adapt the settings if necessary.
9. If the station is part of an media redundant network (ring structure) assign the MRP client role to the fieldbus coupler and adapt the name of the MRP domain if necessary.
10. Check the connection settings at the port submodules of the fieldbus coupler and adapt these if necessary (see also the chapter „Port Configuration”).
11. Build the expected network topology using on-board means of the engineering tool. This is mandatory if the fieldbus coupler runs within an IRT domain. The IO device replacement without using any tool is also only possible if the expected network topology is known to the IO controller. On match of expected and real network topology it is possible to pass on the tool based station name assignment even during the first commissioning.
12. Switch on the fieldbus coupler power supply (see also the chapter „Device Start-Up and Initialization”).
13. Alternative to the topology based station name assignment the station name can be set by a DCP tool (see also the chapter „DCP“) or be defined using the available DIP switch (see also the chapter „DIP switch“).
14. Upload the system data subsequently onto the IO controller.

After a successful connection establishment between the IO controller and the IO device the state of productive data exchange is entered.

8.5 GSD File

The GSD file describes the properties of the fieldbus coupler and I/O modules required for a configuration such as the data length in the respective process image or the parameter data.

This file is created by the device manufacturers and made available to the user. The GSD file is required to configure the IO controller for active data exchange with the fieldbus coupler. It is imported or installed into the configuration software.

An XML-based language, GSDML is used as the language for the device description file.

Structure, content and coding of this device master data are standardized so the software of various manufacturers can be used for the configuration.

Information



More information on the GSD files

The GSD file can be obtained at www.wago.com.

When installing this file, please refer to the information provided in the documentation of the configuration software which you are using.

8.6 Parameterization

Before data can be exchanged between IO controller and IO device, parameterization is required in addition to the hardware configuration in the configuration software. The default attribute values are highlighted in "**bold**".

The configuration is used to set the parameters (attributes) for the fieldbus coupler as a station proxy (DAP) and for the I/O modules based on the device description (GSD). The individual parameters are set via selectable textual descriptions.

8.6.1 Parameterization of the Station Proxy (DAP)

The following list provides an overview of configurable attributes for the station proxy and descriptions of the individual parameters are listed in the subsequent chapter.

Table 39: Parameterization – Overview of attributes for the station proxy (DAP)

Attributes for the station proxy (DAP)	
-	Restart on K-Bus failure
-	Diagnostics of external module/channel errors
-	Internal data bus extension
-	Response to PROFINET IO failure
-	Response to K-Bus failure
-	Activation of the integrated webserver
-	Activation of the WAGO TCP service port
-	Activation of the station-wide PROFIenergy functionality *)
	*) only for DAP with suffix "PE-DAP"

8.6.1.1 Restart on K-Bus failure

Table 40: Parameterization DAP – Attribute Restart on K-Bus failure

Attribute Name	Attribute Value	Description
Restart on K-Bus failure	POWER ON RESET	After any errors have been corrected can the internal data bus be returned to operation by resetting the fieldbus coupler's hardware or software.
	AUTORESET	The internal data bus is returned to operation automatically after any errors have been corrected.

8.6.1.2 Diagnostics of external module/channel errors

Table 41: Parameterization DAP – Attribute Diagnostics of external module/channel errors

Attribute Name	Attribute Value	Description
Diagnostics of external module/channel errors	0 (false)	Pending diagnostic messages are not reported to the respective IO controller irrespective of the submodule parameterization.
	1 (true)	Pending diagnostic messages are reported to the respective I/O controller depending on the submodule parameterization.

8.6.1.3 Internal data bus extension

Table 42: Parameterization DAP – Attribute Internal data bus extension

Attribute Name	Attribute Value	Description
Internal data bus extension	EEPROM-setting is used	The settings are made according to the unlock value saved in the EEPROM.
	is not used	The internal data bus is operated at the standard transmission rate.
	is used	The internal data bus is operated at the reduced transmission rate.

8.6.1.4 Response to PROFINET IO failure

Table 43: Parameterization DAP – Attribute Response to PROFINET IO failure

Attribute Name	Attribute Value	Description
Response to PROFINET IO failure	Output image is stored	For all output submodules parameterized "according to device settings" (default), the output data last valid before the fault remains valid.
	Substitute values are switched	The substitute values parameterized on the part of the output submodules are output.
	Output image is cleared	For all output submodules parameterized "according to device settings" (default), the output data is set to zero.

8.6.1.5 Response to K-Bus failure

Table 44: Parameterization DAP – Attribute Response to K-Bus failure

Attribute Name	Attribute Value	Description
Response to K-Bus failure	PROFINET IO communication is stopped	Any existing IO controller application relationships (IOAR) are terminated.
	Input image gets invalid	Existing IO controller application relationships (IOAR) are not terminated. However, the process data qualifiers of all provider (IOPS) and consumer data (IOCS) are set to the "BAD" status.

8.6.1.6 Activation of the integrated Webserver

Table 45: Parameterization DAP – Attribute Webserver

Attribute Name	Attribute Value	Description
Webserver (TCP Port 80)	0 (false)	TCP/UDP port 80 is disabled. The web server is inaccessible.
	1 (true)	TCP/UDP port 80 is enabled. The web server is accessible.

The web server of the fieldbus coupler is disabled by default and can only be enabled by the DAP parameterization data set. Activity is terminated after any hardware or software reset of the fieldbus coupler.

8.6.1.7 Activation of Firmware Updates

Table 46: Parameterization DAP – Attribute WAGO-Service (TCP Port 6626)

Attribute Name	Attribute Value	Description
WAGO Service (TCP Port 6626)	0 (false)	WAGO TCP service port 6626 is disabled. The device software cannot be updated by a firmware update via ETHERNET.
	1 (true)	WAGO TCP service port 6626 is enabled. The device software can be updated by a firmware update via ETHERNET.

The WAGO service port of the fieldbus coupler is enabled by default and can only be disabled by the DAP parameterization data set.

Inactivity is terminated after any hardware or software reset of the fieldbus coupler.

8.6.1.8 Activation of the station-wide PROFIenergy Functionality

This setting is only available with DAP for PROFIenergy (with the "PE-DAP" ending).

Table 47: Parameterization DAP – Attribute Minimal pause time (PROFIenergy)

Attribute Name	Attribute Value	Description
Minimal pause time	10 sec	Pauses requested by the PROFIenergy profile are only introduced during pause times greater than or equal to the setting made.
	1 min	
	10 min	
	1 h	
	10 h	
	1 d	
	infinity	

8.6.2 Parameterization of the I/O-Modules

The configurable attributes for the various I/O module types are listed in the appendix.

Information



More information on the I/O module parameters!

The individual attribute values and descriptions are available in the appendix in the respective subchapters under the chapter "Parameters for the I/O Modules".

8.7 PROFINET Connection

In addition to the implicit application relationship, two IOARs and one IOSAR are supported.

Connecting an IOAR beyond that is acknowledged negatively by the fieldbus coupler.

8.7.1 Structure of the Application and Communication Relationships (AR and CR)

Once the IO controller has identified the fieldbus coupler by the device name on the fieldbus and then assigned the configured IP settings to it, the fieldbus coupler receives the IO controller's request to establish a connection.

The request contains various request blocks:

- An "ARBlockReq"
- An "IOCBLOCKReq" for input data
- An "IOCBLOCKReq" for output data
- An "ExpectedSubmoduleBlockReq" for each configured module or submodule slot (incl. slot 0 of the DAP)
- An "AlarmCRBlockReq"

8.7.1.1 Connection Response with no Configuration Differences

If the specified configuration can be adapted to the existing actual configuration, the communication relationships (CRs) are established by the fieldbus coupler and the blocks for the communication relationships acknowledged positively in the response from the fieldbus coupler ("IOCBLOCKRes").

Since there is no difference, there is also no "ModuleDiffBlock" in the response from the fieldbus coupler.

8.7.1.2 Connection Response with Configuration Differences

If there are differences in the configurations, the fieldbus coupler returns a "ModuleDiffBlock" in the response to the connection in which all submodules are listed with one or more of the following properties, e.g.:

- DAP revision level incompatible
(byte 2 and/or 3 of the module ID differ)
- Wrong DAP
(byte 0 and/or 1 of the module ID differ)
- One or more incorrectly configured or incorrectly populated module slots
- One or more incorrectly configured or incorrectly populated submodule slots

8.7.2 Parameterization of Submodule's Data Sets

After a connection is established between fieldbus coupler and the respective IO controller, the IO controller parameterizes the configured submodules. This can occur in the form of several write tasks (up to three write requests per submodule) or by one write task (WriteMultiple request for all submodules). Submodules identified in the "ModuleDiffBlock" as "wrong" in the connection acknowledgement do not get any parameterization data from the IO controller.

8.7.3 End of the Parameterization Phase and Operational Readiness

After writing the parameterization data sets from the IO controller to the submodules, the fieldbus coupler acknowledges the end of the parameterization phase ("EndOfParameterization") of the IO controller with the "DControl.req" frame.

After processing the parameterization data sets, the fieldbus coupler signals operational readiness of the PROFINET IO application ("ApplicationReady") to the IO controller.

Beforehand, the fieldbus coupler sends already valid input data (provider data) to the IO controller, which is identified by the "GOOD" status (0x80) of the user data qualifier (IOXS).

8.8 Data Exchange

After the PROFINET IO application of the fieldbus coupler has signaled readiness, the input data are transmitted to the IO controller by provider telegram. At the same time, the fieldbus coupler monitors transmission of the output data as the consumer by the IO controller.

8.8.1 Send Cycle Times (Update Time)

Also called "SendCycle" in PROFINET IO, the update times can take the following values on the part of the provider and consumer.

Table 48: Send cycle time as a function of RT class, transmit clocking and scaling factor

RT class	Transmit clocking [ms]	Scaling factor	Send cycle time [ms]
1 (RT)	1	1 (2 ⁰)	1
		2 (2 ¹)	2
		4 (2 ²)	4
		8 (2 ³)	8
		16 (2 ⁴)	16
		32 (2 ⁵)	32
		64 (2 ⁶)	64
		128 (2 ⁷)	128
		256 (2 ⁸)	256
		512 (2 ⁹)	512
3 (IRT)	1	1 (2 ⁰)	1
		2 (2 ¹)	2
		4 (2 ²)	4
		8 (2 ³)	8
		16 (2 ⁴)	16
		1 (2 ⁰)	2
	2	2 (2 ¹)	4
		4 (2 ²)	8
		8 (2 ³)	16
		16 (2 ⁴)	32
		1 (2 ⁰)	4
	4	2 (2 ¹)	8
		4 (2 ²)	16
		8 (2 ³)	32
		16 (2 ⁴)	64
		1 (2 ⁰)	4
		2 (2 ¹)	8

8.8.2 Connection Monitoring

Monitoring interval (provider data holds)

The monitoring interval is determined by the "DataHoldFactor".

If the provider data of the IO controller fail, the fieldbus coupler signals termination of the application relationship with an RTA alarm after a specific time (T) with the reason "DataHoldTimer expired".

The time (T) is determined as follows:

$$T = (,DataHoldFactor" + 1) * \text{send cycle time}$$

8.9 Demand Data Exchange (acyclic communication)

In addition to cyclic data communication (PROFIBUS IO standard in compliance with IEC 61158), PROFIBUS IO also offers acyclic communication services. These services can be initiated in parallel to productive data exchange.

The fieldbus coupler makes the so-called record data sets available for parameterization purposes or for diagnostic requests. The various data sets are used, for example, for identification and maintenance.

Information



More information on record data sets for parameterization!

The table in the appendix provides a list of special record data sets for parameterization of the modules/submodules in the chapter "Record Data Sets".

Information



More information on record data sets for diagnostics!

You can read more about special record data sets in the context of diagnostics. The structure of standardized diagnostic data sets and channel-specific diagnostics are explained in the chapter "PROFINET IO Diagnostics".

9 Web-based Management (WBM)

The fieldbus coupler has web pages with status information that you can access via the integrated web server.

Access to the web pages requires activation of http port 80 as part of configuring the fieldbus coupler (see chapter "Commissioning" > ... > "Activating the Integrated Web Server").

The web pages can then be accessed via an Internet browser. Your browser must support (enabled) JavaScript to display the web pages correctly.

Note



Maximum three simultaneous client connections to one web page!

Please note that performance can drop with an increasing number of web clients accessing a web page. Therefore, it is recommended that there be no more than three simultaneous client connections to one web page. Up to 20 TCP/IP socket connections to the web server of the fieldbus coupler are possible. The maximum number of persistent socket connections to a web server differs for each browser (typically between 2 and 8).

1. To open the WBM, launch a web browser (e.g., Microsoft Internet Explorer or Mozilla Firefox).
2. Enter the IP address of the fieldbus coupler into the address bar.
3. Enter your user name and password in the query dialog (default: user = "admin", password = "wago").

You can access the following WBM pages via the links given in the navigation bar:

- Information
- Ethernet
- TCP/IP
- Diagnostics
- Administration

9.1 General Structure of WBM Pages

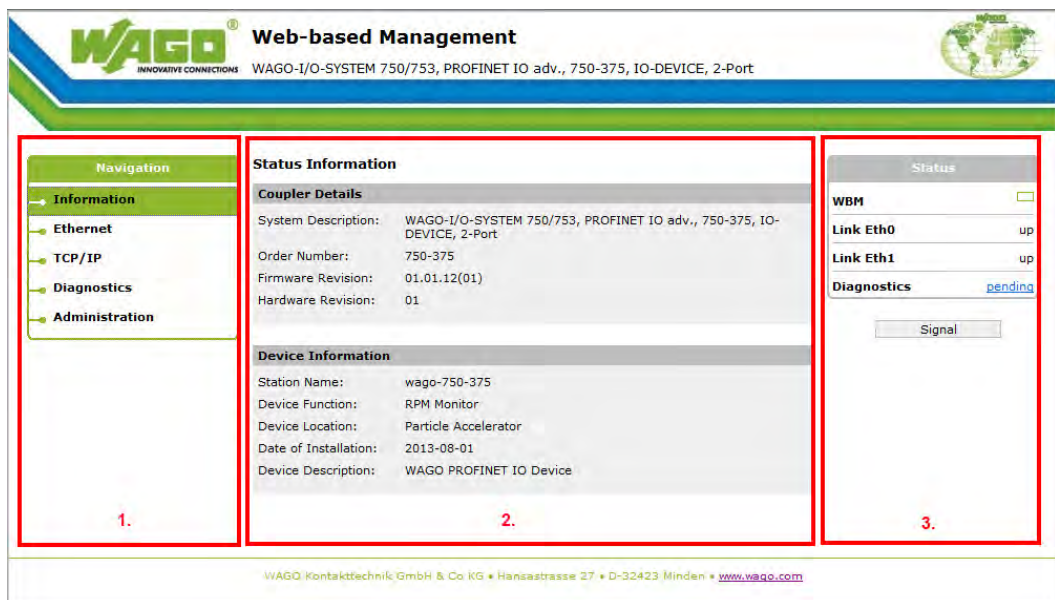

Figure 48: Structure of WBM pages, example: WBM page "Information"

- 1 The left side contains a list of links use to navigate between the individual WBM pages.
- 2 The WBM pages are displayed in the middle area. These are explained in the in the following chapters.
- 3 The top right contains the status area and **[Signal]** button. This status area appears on every navigation level and displays initial information about the fieldbus coupler. This area is automatically refreshed at 3-second intervals.

The **[Signal]** button can be used to activate the node flashing test of the device.

9.1.1 Status Area



Figure 49: WBM pages – Status area

Table 49: Legend for the indicators in the status area

Status		Description
WBM	green	The green status indicator signals activation of the web page.
Link Eth0	up	Indicates that there is a connection on the link level (layer 2) to ETHERNET port 1.
	down	Indicates that there is no connection on the link level (layer 2) to ETHERNET port 1.
Link Eth1	up	Indicates that there is a connection on the link level (layer 2) to ETHERNET port 2.
	down	Indicates that there is no connection on the link level (layer 2) to ETHERNET port 2.
Diagnostics	none	There are no diagnostics for this device.
	pending	There is diagnostic information for this device. You can display with web page with diagnostic information in one step by clicking on the word "pending".

9.2 Information

The WBM page "Information" contains an overview of all important information about your fieldbus coupler.



Figure 50: WBM page „Information“

Table 50: Parameter description of WBM page "Information"

Coupler Details	
System Description	Displays the detailed product description of the fieldbus coupler.
Order Number	Displays the item number of the fieldbus coupler.
Firmware Revision	Displays the current revision of the firmware.
Hardware Revision	Displays the current revision of the hardware.
Device Information	
Station Name	Displays the current PROFINET IO device name.
Device Function	Displays the device function of the PROFINET IO I&M data set.
Device Location	Displays the device location of the PROFINET IO I&M data set.
Date of Installation	Displays the date of installation of the PROFINET IO I&M data set.
Device Description	Displays the description of the PROFINET IO I&M data set.

9.3 Ethernet

The WBM page "Ethernet" contains information about the physical connection to the ETHERNET network and packet statistics for both ETHERNET ports of the fieldbus coupler. The area for packet statistics is automatically refreshed at 3-second intervals. The page has to be reloaded to refresh any other data.

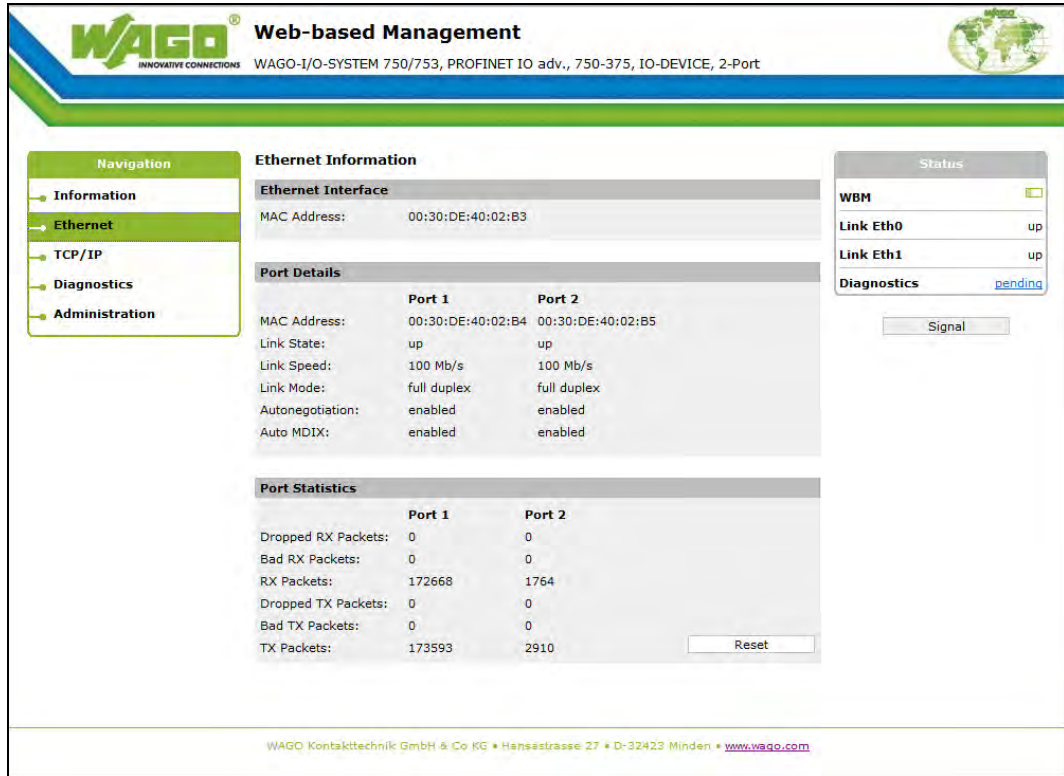

Figure 51: WBM page "Ethernet"

Table 51: Description of the parameters of the WBM page "Ethernet"

Ethernet Interface		
MAC Address	Displays the MAC address, which helps identify and address the fieldbus coupler.	
Port Details		
	Port 1	Port 2
MAC Address	Displays the port MAC address.	
Link State	Displays the current link status (up/down) of the port.	
Link Speed	Displays the current transmission rate of the port (10 Mbit/s or 100 Mbit/s), (full-duplex / half-duplex).	
Link Mode	Displays the current ETHERNET transfer mode of the network.	
Autonegotiation	Displays if the Autonegotiation function is enabled for this port.	
Auto MDIX	Displays if the Auto MDIX function is enabled for this port.	
Port Statistics		
	Port 1	Port 2
Dropped RX Packets	Displays the number of dropped receive packets.	
Bad RX Packets	Displays the number of bad receive packets.	
RX Packets	Displays the total number of receive packets.	
Dropped TX Packets	Displays the number of dropped transmit packets.	
Bad TX Packets	Displays the number of bad transmit packets.	
TX Packets	Displays the total number of transmit packets.	

9.4 TCP/IP

The WBM page "TCP / IP" contains information about the currently existing IPv4 settings.

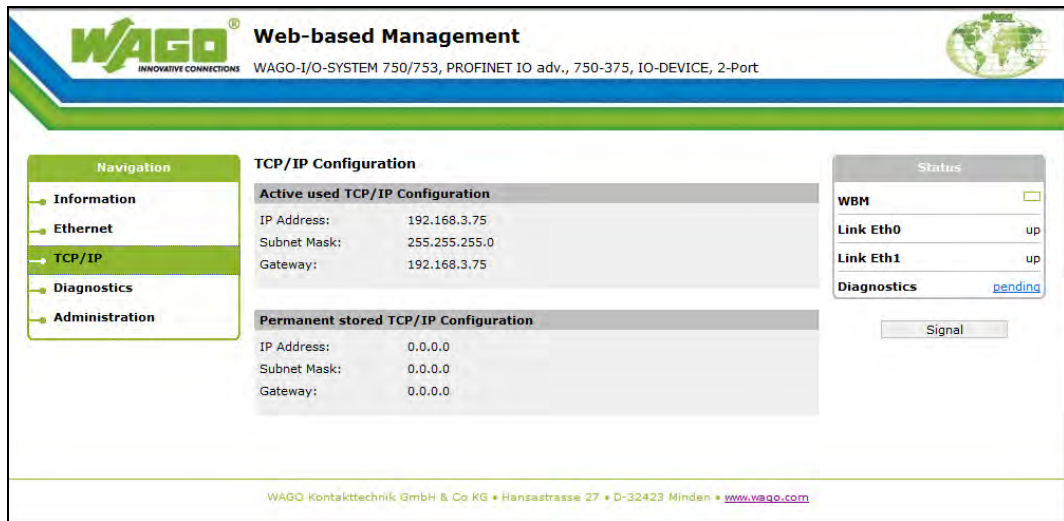

Figure 52: WBM page „TCP/IP“

Table 52: Description of the parameters of the WBM page "TCP/IP"

Active used TCP/IP Configuration	
IP address	Displays the current IP address of the fieldbus coupler.
Subnet mask	Displays the current subnet mask of the fieldbus coupler.
Gateway	Displays the current gateway address of the fieldbus coupler.
Permanent stored TCP/IP Configuration	
IP address	Displays the IP address of the fieldbus coupler stored in non-volatile memory.
Subnet mask	Displays the subnet mask of the fieldbus coupler stored in non-volatile memory.
Gateway	Displays the gateway address of the fieldbus coupler stored in non-volatile memory.

9.5 Diagnostics

In the event of an error, the WBM page "Diagnostics" displays diagnostic messages in the form of a log.

The [**Refresh**] button can be used to refresh the list of diagnostic information.

For evaluation, the item number of the module affected by the error, slot, error code and respective error description are displayed.

The user is referred to the device manual if there is no detailed error description for a diagnostic on the fieldbus coupler.

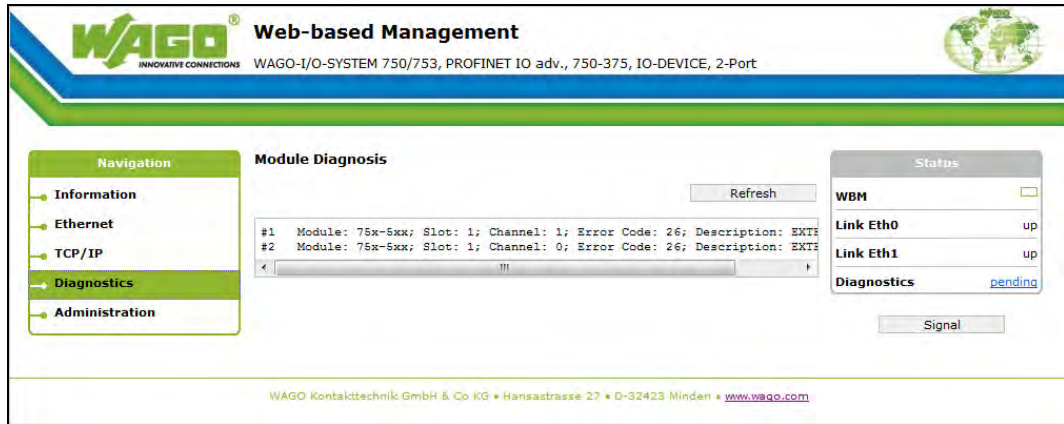

Figure 53: WBM page "Diagnostics"

9.6 Administration

On the WBM page "Administration", the [**Change Password**] button can be used to change the administrator password or the [**Restore default**] button to restore the default password.

All changes are immediately active without having to restart the fieldbus coupler.



Note

Rule for valid passwords!

Note that for valid passwords up to 16 characters are allowed, consisting of letters and numbers, no special characters!

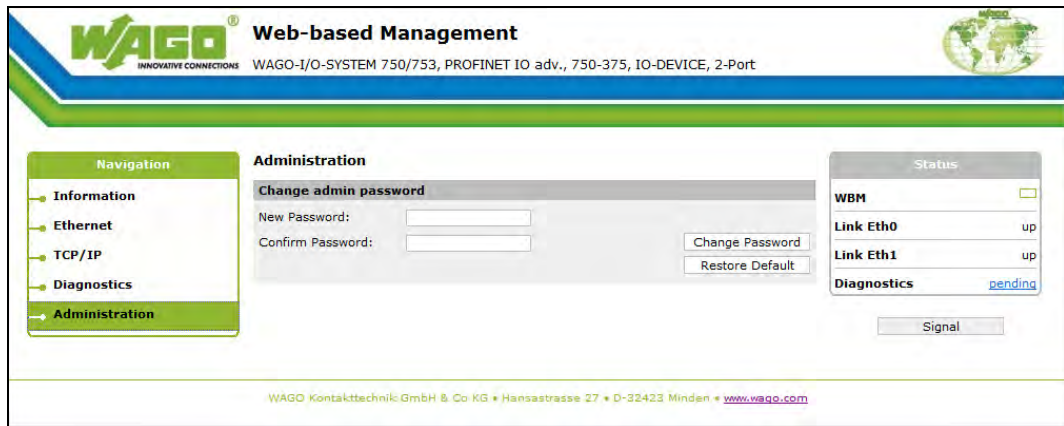

Figure 54: WBM page "Administration"

Table 53: Parameter description of the WBM page "Administration"

Change admin password	
New Password	Enter the new password.
Confirm Password	Enter the new password again to confirm.

9.7 Connection Errors

In the event of an error connecting to a WBM page, "wbm error" is displayed instead of any valid data.

Connection errors may occur due to the following factors:

- The physical ETHERNET connection to the device has been interrupted. In this case, a PROFINET IO diagnostic message should appear. There may be a failure of the entire device.
- The IP connection has been interrupted. Causes may include:
 - Reparameterization of the IP address of the device
 - Failure of the PC network card
- The maximum number of connections (3) to the WBM page has been exceeded

10 Diagnostics

In addition to diagnostics via the WBM (see previous chapter "Web-based Management"), there are two other options for diagnostics for the fieldbus coupler.

The listed diagnostic options are described below:

- LED signaling
for onsite diagnostics
(see chapter "LED Signaling")
- PROFINET IO diagnostics
by reading the diagnostic data sets (records)
(see chapter "PROFINET IO Diagnostics")

10.1 LED Signaling

For on-site diagnostics, the fieldbus coupler has several LEDs that indicate the operational status of the fieldbus coupler or the entire node (see following figure).

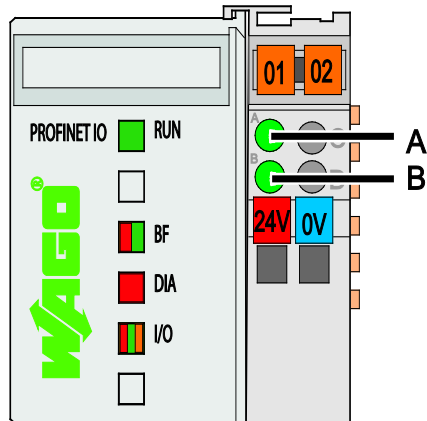

Figure 55: Display Elements

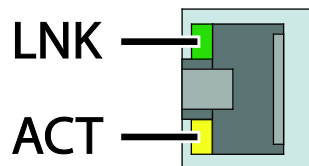

Figure 56: Display Elements Fieldbus Connection RJ-45

The diagnostics displays and their significance are explained in detail in the following section.

The LEDs are assigned in groups to the various diagnostics areas:

Table 54: LED assignment for diagnostics

Diagnostics area	LEDs
Fieldbus status	<ul style="list-style-type: none"> • RUN • BF • DIA
Node status	<ul style="list-style-type: none"> • I/O
Status Supply Voltage	<ul style="list-style-type: none"> • A (system supply) • B (field supply)

10.1.1 Evaluating the Fieldbus Status

The top three LEDs (RUN, BF and DIA) are used to indicate the operating status of PROFINET IO communication.

Table 55: Fieldbus diagnostics – solution in event of error

LED Status	Explanation	Solution
RUN		
green	The power supply is ON.	-
green flashing	Part of or the entire fieldbus node is in energy-saving mode or output mode due to the PROFIenergy "Start Pause" command.	1. Use the PROFIenergy "End Pause" command to exit energy-saving modes.
OFF	The power supply is OFF.	1. Check the power supply (24 V, 0 V).
BF		
green flashing	1 Hz, pulse-no-pulse ratio 1:1 (for 3 sec.): Node flashing test (DCP Control Signal FlashOnce). With repetitive node flashing tests in succession, the indicator light can briefly capture the status of the group fault display (red).	-
red	There is no ETHERNET connection (link).	1. Check the network cable.
red flashing	There is an ETHERNET connection on at least one port. A PROFINET connection (IOAR) is not established.	1. Check the connection between IO controller and IO device. 2. Check if the right device name has been assigned for the IO device. 3. Check if the connected network infrastructure ETHERNET link is 100 Mbit/s full-duplex compliant.
OFF	At lease on application relationship has been established to an IO controller (IOAR).	-
DIA		
red	Parameterization error, module differences or diagnostics display.	1. Check the parameter settings and fieldbus node setup or evaluate the diagnostics display.
<div style="text-align: center;">  <h3 style="margin: 0;">Information</h3> <p>Evaluating the diagnostics display! A detailed description of the diagnostics display analysis is available in the chapter "PROFINET IO Diagnostics"!</p> </div>		

The integrated LNK and ACT LEDs display the physical fieldbus connection and network activity on the RJ-45 fieldbus connections directly.

Table 56: Diagnostics of the fieldbus status on the fieldbus connection – solution in event of error

LED Status	Explanation	Solution
LNK		
green	Connection to physical network exists.	-
OFF	No connection to physical network.	1. Check the network connection.
ACT		
yellow	Network activity.	-
OFF	No network activity.	-

10.1.2 Evaluating the Node Status

The I/O LED indicates the operating status of communication between the fieldbus coupler and I/O modules.

Table 57: Node status diagnostics – Solution in event of error

LED Status	Explanation	Solution
I/O		
green	Data cycle on the internal data bus.	Normal operating conditions.
orange permanent	The boot loader is copying the device firmware from the flash memory to the working memory of the fieldbus coupler.	-
red permanent	Fieldbus coupler has a hardware defect	Replace the fieldbus coupler.
red flashing	Flashing at approx. 10 Hz points to initialization of the internal data bus or to a general internal data bus error.	Note the following blinking sequence.
red cyclical flashing	Up to three successive blinking sequences indicate internal data bus errors. There are short intervals between the sequences.	Evaluate the blinking sequences based on the following blink code table. The blinking indicates an error message comprised of an error code and error argument.
OFF	No data cycle on the internal data bus.	The fieldbus coupler supply is off.

After switching on the power supply, the boot loader copies the device firmware to the working memory, the I/O LED lights up orange.

The device firmware then starts and initializes the internal data bus. This is indicated by red flashing at 10 Hz for 1-2 seconds.

After starting up without any errors, the I/O LED lights up green.

In the event of error, the I/O LED flashes red.

The flash codes are used to indicate detailed error messages. An error is indicated by up to 3 cyclical flash sequences.

After eliminating the error, restart the fieldbus node by switching the fieldbus coupler power supply off and on again.

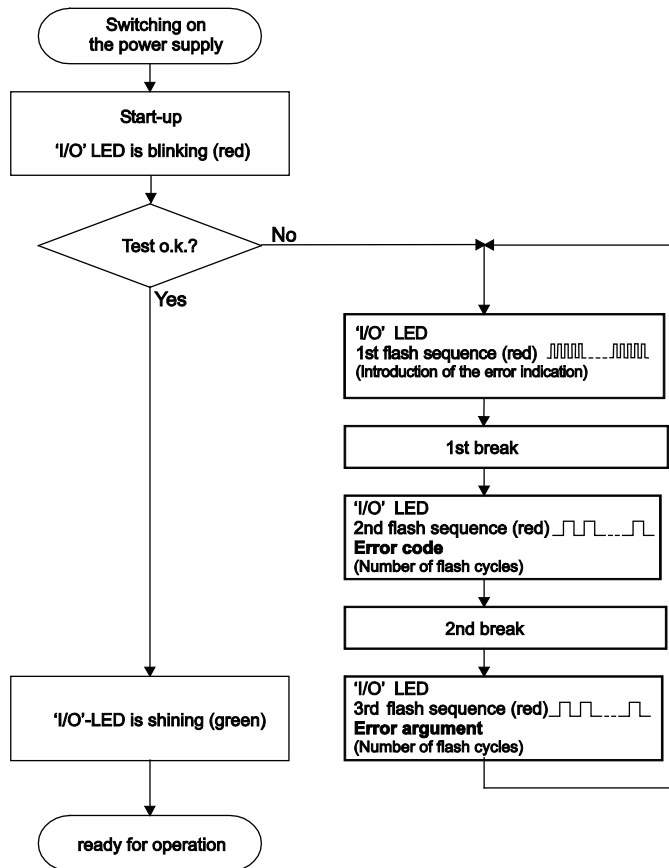

Figure 57: Node status - I/O LED signaling

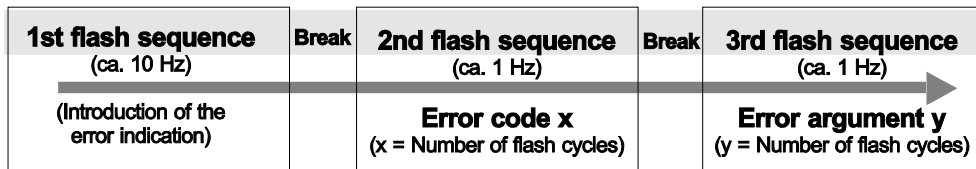

Figure 58: Error message coding

Example of a module error:

- The I/O LED starts the error display with the first flash sequence (approx. 10 Hz).
- After the first pause, the second flash sequence (approx. 1 Hz) starts: The I/O LED flashes four times. Error code 4 indicates "data error internal data bus".
- After the second pause, the third flash sequence starts (approx. 1 Hz): The I/O LED flashes twelve times. Error argument 12 means that the internal data bus is interrupted behind the twelfth active I/O module.

The thirteenth I/O module is either defective or has been removed from the network.

Table 58: Blink code- table for the I/O LED signaling, error code 1

Error code 1: "Hardware and configuration error"		
Error Argument	Error Description	Solution
-	Invalid check sum in the parameter area of the fieldbus controller.	<ol style="list-style-type: none"> 1. Turn off the power supply for the node. 2. Replace the fieldbus controller. 3. Turn the power supply on again.
1	Overflow of the internal buffer memory for the attached I/O modules.	<ol style="list-style-type: none"> 1. Turn off the power for the node. 2. Reduce the number of I/O modules. 3. Turn the power supply on again. 4. If the error persists, replace the fieldbus controller.
2	I/O module(s) with unknown data type	<ol style="list-style-type: none"> 1. Determine the faulty I/O module by first turning off the power supply. 2. Plug the end module into the middle of the node. 3. Turn the power supply on again. 4. - LED continues to flash? - Turn off the power supply and plug the end module into the middle of the first half of the node (toward the fieldbus controller). - LED not flashing? - Turn off the power and plug the end module into the middle of the second half of the node (away from the fieldbus controller). 5. Turn the power supply on again. 6. Repeat the procedure described in step 4 while halving the step size until the faulty I/O module is detected. 7. Replace the faulty I/O module. 8. Inquire about a firmware update for the fieldbus controller.
3	Unknown module type of the Flash program memory	<ol style="list-style-type: none"> 1. Turn off the power supply for the node. 2. Replace the fieldbus controller. 3. Turn the power supply on again.
4	Fault when writing in the Flash program memory.	<ol style="list-style-type: none"> 1. Turn off the power supply for the node. 2. Replace the fieldbus controller. 3. Turn the power supply on again.
5	Fault when deleting the Flash memory.	<ol style="list-style-type: none"> 1. Turn off the power supply for the node. 2. Replace the fieldbus controller. 3. Turn the power supply on again.
6	The I/O module configuration after AUTORESET differs from the configuration determined the last time the fieldbus controller was powered up.	<ol style="list-style-type: none"> 1. Restart the fieldbus controller by turning the power supply off and on.
7	Fault when writing in the serial EEPROM.	<ol style="list-style-type: none"> 1. Turn off the power supply for the node. 2. Replace the fieldbus controller. 3. Turn the power supply on again.

Table 58: Blink code- table for the I/O LED signaling, error code 1

Error code 1: "Hardware and configuration error"		
Error Argument	Error Description	Solution
8	Invalid hardware-firmware combination.	<ol style="list-style-type: none"> 1. Turn off the power supply for the node. 2. Replace the fieldbus controller. 3. Turn the power supply on again.
9	Invalid check sum in the serial EEPROM.	<ol style="list-style-type: none"> 1. Turn off the power supply for the node. 2. Replace the fieldbus controller. 3. Turn the power supply on again.
10	Serial EEPROM initialization error	<ol style="list-style-type: none"> 1. Turn off the power supply for the node. 2. Replace the fieldbus controller. 3. Turn the power supply on again.
11	Fault when reading in the serial EEPROM.	<ol style="list-style-type: none"> 1. Turn off the power supply for the node. 2. Replace the fieldbus controller. 3. Turn the power supply on again.
12	Timeout during access on the serial EEPROM	<ol style="list-style-type: none"> 1. Turn off the power supply for the node. 2. Replace the fieldbus controller. 3. Turn the power supply on again.
14	Maximum number of gateway or mailbox modules exceeded	<ol style="list-style-type: none"> 1. Turn off the power for the node. 2. Reduce the number of corresponding modules to a valid number. 3. Turn the power supply on again.

Table 59: Blink code table for the I/O LED signaling, error code 2

Error code 2: -not used-		
Error Argument	Error Description	Solution
-	Not used	-

Table 60: Blink code table for the I/O LED signaling, error code 3

Error code 3: "Protocol error, internal bus"		
Error Argument	Error Description	Solution
-	Internal data bus communication is faulty, defective module cannot be identified.	<p>- Are passive power supply modules (750-613) located in the node? -</p> <ol style="list-style-type: none"> 1. Check that these modules are supplied correctly with power. 2. Determine this by the state of the associated status LEDs. <p>- Are all modules connected correctly or are there any 750-613 Modules in the node? -</p> <ol style="list-style-type: none"> 1. Determine the faulty I/O module by turning off the power supply. 2. Plug the end module into the middle of the node. 3. Turn the power supply on again. 4. - LED continues to flash? - Turn off the power supply and plug the end module into the middle of the first half of the node (toward the fieldbus coupler). - LED not flashing? - Turn off the power and plug the end module into the middle of the second half of the node (away from the fieldbus coupler). 5. Turn the power supply on again. 6. Repeat the procedure described in step 4 while halving the step size until the faulty I/O module is detected. 7. Replace the faulty I/O module. 8. Inquire about a firmware update for the fieldbus coupler.

Table 61: Blink code table for the I/O LED signaling, error code 4

Error code 4: “Physical error, internal bus”		
Error Argument	Error Description	Solution
-	Internal bus data transmission error or interruption of the internal data bus at the fieldbus coupler	<ol style="list-style-type: none"> 1. Turn off the power supply to the node. 2. Plug in an end module behind the fieldbus coupler. 3. Turn the power supply on. 4. Observe the error argument signaled. <p>- Is no error argument indicated by the I/O LED? -</p> <ol style="list-style-type: none"> 5. Replace the fieldbus coupler. <p>- Is an error argument indicated by the I/O LED? -</p> <ol style="list-style-type: none"> 5. Identify the faulty I/O module by turning off the power supply. 6. Plug the end module into the middle of the node. 7. Turn the power supply on again. 8. - LED continues to flash? - Turn off the power and plug the end module into the middle of the first half of the node (toward the fieldbus coupler). - LED not flashing? - Turn off the power and plug the end module into the middle of the second half of the node (away from the fieldbus coupler). 9. Turn the power supply on again. 10. Repeat the procedure described in step 6 while halving the step size until the faulty I/O module is detected. 11. Replace the faulty I/O module. 12. If there is only one I/O module on the fieldbus coupler and the LED is flashing, either the I/O module or fieldbus coupler is defective. Replace the defective component.
n*	Interruption of the internal data bus behind the nth I/O module with process data	<ol style="list-style-type: none"> 1. Turn off the power supply to the node. 2. Replace the (n+1) I/O module containing process data. 3. Turn the power supply on.

* The number of light pulses (n) indicates the position of the I/O module.
I/O modules without data are not counted (e.g., supply modules without diagnostics)

Table 62: Blink code table for the I/O LED signaling, error code 5

Error code 5: “Initialization error, internal bus”		
Error Argument	Error Description	Solution
n*	Error in register communication during internal bus initialization	<ol style="list-style-type: none"> 1. Turn off the power supply to the node. 2. Replace the (n+1) I/O module containing process data. 3. Turn the power supply on.

* The number of light pulses (n) indicates the position of the I/O module.
I/O modules without data are not counted (e.g., supply modules without diagnostics)

Table 63: Blink code table for the 'I/O' LED signaling, error code 6

Error code 6: -not used-		
Error Argument	Error Description	Solution
-	Not used	

Table 64: Blink code table for the 'I/O' LED signaling, error code 7...8

Error code 7...8: -not used-		
Error Argument	Error Description	Solution
-	Not used	

Table 65: Blink code table for the I/O LED signaling, error code 9

Error code 9: "CPU Trap error"		
Error Argument	Error Description	Solution
1	Illegal Opcode	Fault in the program sequence. 1. Please contact the I/O Support.
2	Stack overflow	
3	Stack underflow	
4	NMI	

Table 66: Blink code table for I/O LED signaling, error code 10...11

Error code 10...11: -not used-		
Error argument	Error description	Remedy
-	not used	-

Table 67: Blink code table for I/O LED signaling, error code 12

Error code 12 "Initialization error, internal bus"		
Error Argument	Error description	Remedy
n*	Error with parameter communication during internal bus initialization	<ol style="list-style-type: none"> 1. Switch off the power for the node. 2. Ensure that the nth module with process data is supplied with power at the field side. 3. Switch the power on.

* The number of light pulses (n) indicates the position of the I/O module.
I/O modules without data are not counted (e.g. supply modules without diagnostics)

10.1.3 Evaluating Power Supply Status

The power supply unit of the device has two green LEDs that indicate the status of the power supplies.

LED "A" indicates the 24 V supply of the coupler.

LED "B" or "C" reports the power available on the power jumper contacts for field side power.

Table 68: Power supply status diagnostics – solution in event of error

LED Status	Meaning	Solution
A		
Green	Operating voltage for the system is available.	-
Off	No power is available for the system	Check the power supply for the system (24 V and 0 V).
B or C		
Green	The operating voltage for power jumper contacts is available.	-
Off	No operating voltage is available for the power jumper contacts.	Check the power supply for the power jumper contacts (24 V and 0 V).

10.2 Error Response

10.2.1 Fieldbus Failure

A fieldbus failure is indicated if the IOC is switched off or the fieldbus cable is interrupted. An error in the IOC can also lead to a fieldbus failure.

A fieldbus failure is displayed on the "BF" LED either red flashing or red continuous.

Information



More information on the "BF" LED display!

You can get display breakdown of the "BF" LED in the chapter "Evaluating the Fieldbus Status" in the table "Fieldbus diagnostics – solution in event of error".

If PROFINET IO data exchange fails, e.g. physical connection to the IO controller terminated or in the "STOP" state of the respective control, the fieldbus coupler outputs the configured substitute values to the respective I/O modules depending on the configured substitute value strategy to the values shown in the table below.

The same behavior is applied if the IOC sets the provider states of respective submodules to 'BAD'. On start-up of the node process values corresponding to output values zero are output.

Table 69: Diagnosis of fieldbus failure

Substitute value strategy	Value (bit-oriented)	Substitute value strategy
write output process image to Zero	0	0 or 4 mA, 0 V
hold last valid output process image	last output state	last output value
substitute value	0 or 1	0/4 - 20 mA, -10 - +10 V

The values are set by the fieldbus coupler to the internal data bus output data process image.

Once the PROFINET IO connection has been reestablished, the respective output modules receive their process data again from the IO controller responsible.

10.2.2 Internal Data Bus Failure

'I/O' LED indicates an internal bus failure.

'I/O' LED flashed red:

When an internal data bus failure occurs, the fieldbus coupler generates an error message (error code and error argument).

An internal data bus failure occurs, for example, if an I/O module is removed.

If the error occurs during operation, the output modules operate as they do during an internal data bus stop.

If the internal data bus error is resolved, the process data transfer can be continued, according to the DAP parameter setting (attribute "Restart on K-bus (internal data bus) failure") either immediately or by turning the power off and restarting the fieldbus node.

10.3 PROFINET IO Diagnostics

PROFINET IO allows exact diagnostics of the type and source of an occurring error by reading the record data sets for the diagnostics.

The respective configuration software / IO supervisor is normally used, which provides graphical processing of the diagnostic data (e.g. STEP 7, etc.).

In addition to the record data sets for module/submodule parameterization, a number of record data sets are available for acyclic communication for diagnostics (listed in the following chapter).

The structure of the standardized diagnostic data sets and channel-specific diagnostics are then explained.

Standard and manufacturer-specific diagnostic data sets are mapped according to the extended channel diagnostics.

10.3.1 Diagnosis Data Sets

The diagnostic information of the fieldbus coupler (IO device) can be read acyclically using standard diagnosis data sets (records). The structure of the data sets is defined in the PROFINET IO specification.

More details are available in the specification under "IODReadReq" or "IODReadRes".

The data set number (index) makes it possible to distinguish between the diagnostics level (device, module, submodule or channel error) and the diagnostics structures.

The list of diagnosis data sets listed below provides the respective message structures in the case of pending diagnostics.

Table 70: Retrievable record data sets for diagnostics

Data set number (index)	Description	Available on slot
0x800A	Standardized channel diagnostics of a submodule slot (subslot specific)	0 ... 250
0x800B		
0x800C		
0xC00A	Channel diagnostics of a slot (slot specific); currently identical with the data set number 800A, as only one submodule can exist for each module.	0 ... 250
0xC00B		
0xC00C		
0xE002	Deviations in the specified and actual configuration of the submodules assigned to the IO controller (IOAR).	0
0xE00A	Channel diagnostics of all signal channels allocated to a connection (AR), contains all channel diagnostics structures of the submodule slots.	0
0xE00B		
0xE00C		
0xF00A	Channel diagnostics of all signal channels allocated to the application profile 0 (API 0) ¹⁾ , contains all channel diagnostics structures of the individual submodule slots.	0
0xF00B		
0xF00C		

¹⁾ Several connections (ARs) can be established to an application profile (API).

10.3.2 Structure of the Standardized Diagnosis Data Sets

The diagnosis data sets consist of several structure elements. The first element in the data set is the head of the structure. It describes the version and the length of the following data. An identifier (BlockType) specifies the structure of the diagnosis data.

The identifiers listed below are currently used by the fieldbus coupler:

- 0x0010: Channel diagnostics
- 0x8104: Difference between expected/real configuration

The version enables you to see if the process type (Application Process Identifier – API) follows immediately after the head structure or not:

- Version 1.0: Data set does not contain the API
- Version 1.1: Data set contains the API

The head of the structure has a length of 6 bytes for the description of the version and length of the following data and is structured as follows:

Table 71: Structure head for the diagnostic data

Byte offset	Data type			Description
0 / 1	WORD			Database contents
				0x0010 Extended channel diagnostics
				0x8104 Difference between expected/real configuration
2 / 3	WORD			Length of the data set in bytes
				Length of the version in bytes including
4 / 5	BYTE	0x01		Version (major) = 1
	BYTE			Version (minor)
				0 Diagnostic data follows
				1 API follows
6 / 7	DWORD	0x00	0x00	API = 0
8 / 9		0x00	0x00	Only available in version 1.1

The "API" process type has a data length of 4 bytes. Depending on the version of the data set, the diagnostic data follows at byte offset 6 (version 1.0) or byte offset 10 (version 1.1).

The description of the diagnostic data in the subchapters, depending on the "BlockType", begins back with byte offset 0.

Information



More information on extended channel-specific diagnostics!

More information on extended channel diagnostics is available in the appendix in the chapter "Channel-Specific Diagnostics".

11 Fieldbus Communication

Fieldbus communication between IOC of the control application and fieldbus coupler occurs via the application protocol PROFINET IO.

In addition, there are also other standard ETHERNET protocols implemented, which on the one hand provide the basis for the PROFINET IO communication and on the other hand, serve the reliable data transmission and the network management.

All available protocols are briefly described in the following sections.

11.1 Standard ETHERNET Protocols

11.1.1 IP, TCP and HTTP

- **IP**
The fieldbus coupler supports the Internet Protocol (IPv4) acc. to RFC791.
- **TCP**
The fieldbus coupler supports the TCP Protocol acc. to RFC 675, RFC 793, RFC 1122, RFC 2581, RFC 5681.
- **HTTP**
The implemented HTTP server is used for reading out the HTML pages, which are stored in the coupler. The HTML pages provide information about the coupler, such as status and configuration. The HTTP server uses port number 80.

11.1.2 DCP

Via DCP, to still unaddressed devices in a PROFINET IO system can be distributed addresses and names, so that they are then accessible and able to communicate via the IP protocol in the network. DCP provides various services for request and assignment of address information, such as the DCP_Identify request and the DCP_Get and DCP_Set services.

After the first supply voltage application, the coupler is in state of factory setting, that means the device name (Name Of Station) is not available (empty string, NIL) and the IP settings “address”, “subnet mask”, and “default gateway” each are set to 0.0.0.0.

The fieldbus coupler is only reachable via ICMP if a device name and valid IP-settings are assigned via DCP_Set services.

11.1.3 LLDP

The layer 2 protocol LLDP enables a device on the local network (LAN) to send information about themselves and to receive information from neighboring devices.

The device stores the received information in its "LLDP MIB", from which the information then can be queried by a network management system using SNMP.

LLDP is sent in periodic intervals to a specific MAC address (MAC-ID: 01-80-C2-00-00-0E with the ether type = 0x88CC).

It is a one-way transmission, because communication to other devices is not established. Emitted data packets are not acknowledged by receiving packets. Sending and receiving takes place independently.

11.1.4 MRP

MRP is specified according to IEC 62439 and enables the changeover of the communication paths for TCP/IP and RT_CLASS_1 traffic within 200 ms on error.

To applicate such method there are one Media Redundancy Manager (MRM) such as one or more Media Redundancy Clients (MRC) required, which are connected as a ring structure. Thus the installed devices must have at least 2 Ethernet ports. The MRM, which is commonly implemented on an IO controller or a PROFINET IO switch, separates the ring into a virtual line structure while sending the frames to the connected devices only via one port during proper operation.

Furthermore it checks the configured ring for potential breaks using rotating test frames, which are only forwarded to the connected neighbor device by MRC. Does the MRM not receive the test frame sent on a first port via the second one it detects the location of ring's break and sends the frames of no longer via a first port reachable devices on the second port.

11.1.5 SNMP

The Simple Network Management Protocol (SNMP) is responsible for transporting the control data that allows the exchange of management information as well as status and statistic data between individual network components and a management system.

An SNMP management workstation polls the SNMP agents to obtain information on the relevant devices.

SNMP is supported in versions 1/2c.

This represents a community message exchange in SNMP versions 1 and 2c. The community name of the network community must thereby be specified.

The device data, that can be accessed or modified by an SNMP agent, is called SNMP object. The sets of SNMP objects are stored in a logical database called

Management Information Base (MIB); this is why these objects are typically known as "MIB objects".

The SNMP of the fieldbus coupler includes the general MIB acc. to RFC1213 (MIB II).

11.2 PROFINET IO

11.2.1 General

In the field of industrial automation technology, productive data exchange between higher-level control systems and remote I/O modules is increasingly handled by ETHERNET-based communication systems. This allows you to implement integrated information exchange from the management level to the process-oriented installed I/O units on existing infrastructures.

PROFINET (Process Field Network) represents systematic further development of the global fieldbus system PROFIBUS based on ETHERNET. It takes advantage of the many benefits offered by the open industrial ETHERNET standard.

By using ETHERNET, the transmission rate is increased from 12 Mbit/s half-duplex for RS-485 to 100 Mbit/s full-duplex for PROFINET.

For parameterization, configuration and diagnostics, PROFINET uses the UDP protocol. The requirements for connecting to higher levels, e.g. to Enterprise Resource Planning (ERP) or to the Manufacturing Execution System (MES) are met.

PROFINET not only applies IT standards, but also supports fail-safe applications and covers the complete range of drive engineering through its real-time feature.

For PROFINET IO, remote field devices (IO devices) are connected to the central (IO controller). A WAGO fieldbus node with the PROFINET IO fieldbus coupler handles the function of an IO device in a PROFINET IO network. The familiar I/O view of PROFIBUS is maintained in doing so. The properties of the field device are declared to Engineering based on GSD files. The respective GSD file is available from the device manufacturer.

PROFINET IO uses RT (Real-Time) communication for high-performance transmission of process data.

For increased requirements for determinism, IRT (Isochronous Real Time) communication allows you to implement, e.g. applications with motion control.

In addition, PROFINET IO makes it possible to move the devices in the network (IO devices) independently at different update times ("Send Cycles") based on their performance capability. This is accomplished by scaling the global send cycle ("Send Clock") in multiple communication phases.

Investment protection of existing systems plays a significant role for PROFINET. Therefore, the plan has been to integrate existing fieldbus systems such as PROFIBUS, INTERBUS, etc. from the beginning.

Standard network topologies such as star, tree, line and ring can be implemented using PROFINET. That way, the specific demands of Ethernet networks can be met in industrial environments.

A high standard of quality is ensured through inspections conforming to standards carried out within the PROFINET network and the certification of PROFINET devices.

Information



More information on PROFIBUS and PROFINET!

Much more information on PROFIBUS and PROFINET such as technical descriptions and guidelines is available on the web site of the "PROFIBUS & PROFINET International (PI)" umbrella organization at: www.profibus.com.

11.2.2 Cabling

A network for PROFINET IO is based on fast ETHERNET transmission at 100 Mbit/s over copper lines or fiber optic cables in star, tree, line or ring topology.

If PROFINET fieldbus nodes have integrated switches, a network for PROFINET IO can be set up in a linear structure.

If the connection between two field devices by integrated switches in a line (similar to PROFIBUS) is interrupted, the field devices located after the interruption are no longer accessible. To ensure the high availability of nodes in an automation system, redundant communication paths should be considered during system planning.

Information



More information on PROFINET cabling!

A description of PROFINET cabling is available in the "PROFINET Installation Guide". The guide is available for download free of charge on the PROFIBUS user organization web site: www.profibus.com.

11.2.3 PROFINET IO Device Classes

With PROFINET IO, process data is exchanged based on the provider/consumer model. The provider gives the process data to a consumer for processing (PLC with an application program or IO controller). The same applies in the opposite direction (output data of the IO controller to the IO device).

The following device classes are defined for better structuring of field devices in PROFINET IO:

- IO Supervisor
- IO controller
- IO Device

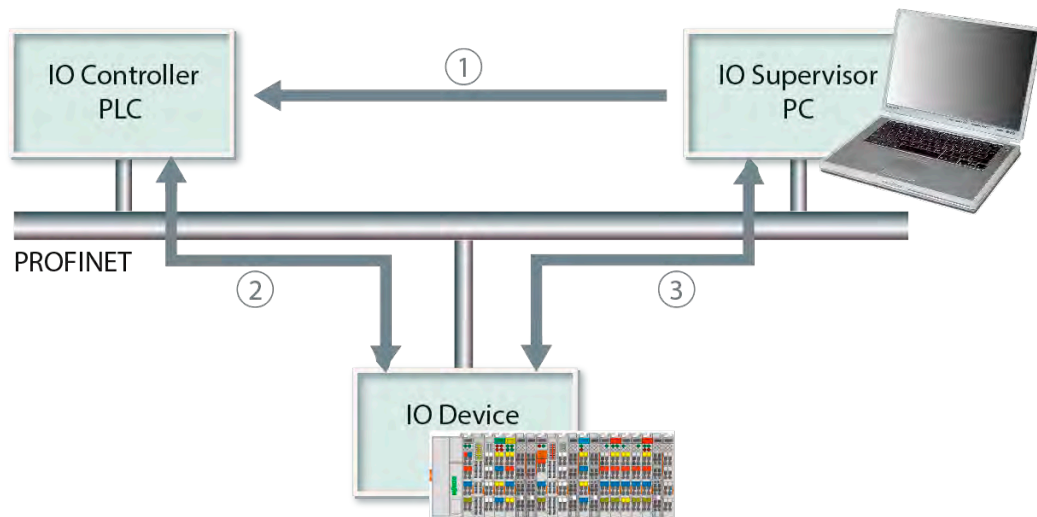

Figure 59: PROFINET principle

- (1) Use of the IO supervisor is initially only needed temporarily at the beginning of the configuration of the PROFINET I/O controller. The IO supervisor (e.g. an engineering station) is typically a programming device (PD), personal computer (PC) or Human Machine Interface (HMI) device for commissioning or diagnostics.
- (2) The IO controller is used to configure IO devices and to exchange process data and alarms with the IO devices. The IO controller is part of a higher-level controller (PLC) in the PROFINET network in which the automation program is running (compared with PROFIBUS that would be the functionality of a class 1 master). The IO device is a remote IO device coupled via PROFINET IO (compared with PROFIBUS, this corresponds to the function of a slave). In a PROFINET network, there is at least one IO controller and one or more IO devices.
- (3) The IO supervisor can carry out individual parameterization (iPar) of specific modules on the IO devices (e.g. safety by means of WAGO SEDI) directly. It can also take over status and control tasks for the IO devices and be used for diagnostics of IO devices in the network.

11.2.4 Addressing

The physical MAC address of a device is used to uniquely address a PROFINET IO field device (IO device) within a network. In addition, each switch port in a field device is identified by a separate port MAC address, so that a 2-port field device has a total of 3 MAC addresses.

The additional MAC addresses of the ports are only used in conjunction with LLDP for topology determination.

With addressing to the MAC address, an IO device first receives a device name as part of the configuration (station naming) using DCP. The IO device stores this unique device name in non-volatile memory.

The device name enables the IO controller to allocate the station proxy with an IP address, subnet mask and standard gateway for establishing productive data exchange when starting the system.

Alternatively a device name instance can predefined in the WAGO fieldbus coupler PROFINET IO via the DIP switch.

11.2.5 PROFINET Communication Principle

11.2.5.1 Data Traffic

Various types of data traffic are used for PROFINET communication.

- **Cyclic real-time data traffic (RT/IRT)**
In cyclic data exchange, the I/O data of the individual I/O modules (modules/submodules) takes a proportionate share (subslots) in the provider and consumer telegram. The I/O data is transmitted unacknowledged between the IO controllers and associated IO devices, but each subslot contains additional status information that provides information on the validity of the information transferred. If cyclic message traffic fails, connection monitoring of both devices ensures that the established application relationship is terminated.
- **Acyclic real-time data traffic (RTA)**
Events such as fault conditions on I/O module peripherals, e.g. "undervoltage" or "short circuit", user limits exceeded or failure of the process data connection and transferred per associated alarm between the IO controllers and associated IO devices.
- **Data cross traffic**
Cyclic data transmission from one provider to several nodes is implemented as data cross traffic. With PROFINET IO, this type of transmission is called Multicast Communication Relation (MCR).
- **Reading and writing data sets (records)**
Demand data, e.g. I/O module parameterizations, device identification and maintenance information, as well as extended channel and module diagnostics, are transferred via the RPC protocol over the UDP channel.

11.2.5.2 Communication Connection

To establish a communication link between the IO controller and an IO device, the communication paths must be established.

They are established during system start-up by the IO controller based on the configuration data received from the configuration software. All data exchange is embedded in a "Application Relationship" (AR). A precisely specified relationship (AR) is established between the IO controller and IO device.

"Communication Relationships" (AR) uniquely specify the data within the AR. Multiple ARs from different IO controllers can be set up for one IO device.

11.2.5.3 Application and Communication Relationship (AR, CR)

The IO controller initiates an application relationship during system start-up. In addition to general communication parameters, all data for device modeling is loaded into the IO device. At the same time, the communication channels for cyclic/acyclic data exchange (IO Data CR, Record Data CR), alarms (Alarm CR) and multicast communication relationships (MCR) are set up.

Within an AR, communication relationships (CR) must be established for data exchange. A unique communication channel between a consumer and provider is specified.

11.2.6 System Start-Up

After power-on or reset, the IO controller initiates start-up of the PROFINET IO system. From the user's perspective, the system start-up is completely autonomous.

During system start-up, the IO controller uses the "connect frame" to initiate the connection and transfers all data required to establish an AR and the required CRs.

The data contains the relevant parameterization data, as well as the sequence, process data traffic and monitoring time for system start-up.

The transmission frequency of the cyclic IO data is determined when configuring the I/O controller.

At the same time, the cyclic IO data, alarms, exchange of acyclic read/write services, expected modules/submodules and possibly required cross connections between IO devices are also determined.

With specific "write frames", the IO controller parameterizes the configured submodules that represent the data interface for the process.

When all parameters are loaded into the IO device, the IO controller signals parameterization to be complete with the "DControl.req" frame ("EndOfParameterization").

The user software then creates the final data structures and updates the submodule status.

When all data structures have been created in the IO device and the required tests have been performed, the IO device sends a "CControl.req" to the IO controller to indicate readiness for productive data exchange ("Application Ready"). From the perspective of the IO device, communication has been established.

With acknowledgement from the IO controller to "Application Ready", communication is established again from the perspective of the IO controller.

The IO device reports errors discovered during parameterization to the IO controller.

After the first successful exchange of IO data the system start-up is complete.

11.2.7 Data Exchange

After successful system start-up, IO controllers and associated IO devices can exchange cyclic process data, alarms and acyclic demand data.

11.2.8 Using Configuration Software

11.2.8.1 Hardware Configuration in the Configuration Software

The hardware configuration in the configuration software used is used to configure and parameterize the hardware of an automation project.

The hardware modules are selected from an electronic catalog and assigned to the associated slots in the fieldbus node. Channel-granular assignment is possible using subslots.

Configuration of additional nodes is identical.

11.2.8.2 Parameterization in the Configuration Software

Parameterization can begin when the hardware configuration is completed.

- Parameterization of the IO controller:
Properties such as start-up characteristics and cycle time monitoring can be set for the IO controller. These settings are stored on the IO controller.
- Parameterization of the IO devices:
Input masks can be used to set various parameters for each module within an IO device, i.e. for DAP and IO modules. The IO device is automatically parameterized during system start-up of the IO controller. The IO device can be replaced without having to parameterize the IO device again.

11.2.8.3 Communication Configuration in the Configuration Software

Configuration settings for communication, settings for time-controlled cyclic and even-driven data transmission and for the display mode of system diagnostics can be made in the configuration software.

For the IO controller, for example, additional information can be displayed for diagnostics, e.g. cause of an error in a user program, display of the cycle time (longest, shortest and last cycle), display of used or free memory, options for and utilization of communication or even display of performance data (e.g. number of possible inputs/outputs, times, etc.).

12 I/O Modules

For modular applications with the WAGO-I/O-SYSTEM 750/753, different types of I/O modules are available

- Digital Input Modules
- Digital Output Modules
- Analog Input Modules
- Analog Output Modules
- Special Modules
- System Modules

For detailed information on the I/O modules and the module variations, refer to the manuals for the I/O modules.

You will find these manuals on the WAGO web pages under <http://www.wago.com>.



Information

More Information about the WAGO-I/O-SYSTEM

Current information on the modular WAGO-I/O-SYSTEM is available in the Internet under: <http://www.wago.com>

13 Use in Hazardous Environments

The **WAGO-I/O-SYSTEM 750** (electrical equipment) is designed for use in Zone 2 hazardous areas.

The following sections include both the general identification of components (devices) and the installation regulations to be observed. The individual subsections of the “Installation Regulations” section must be taken into account if the I/O module has the required approval or is subject to the range of application of the ATEX directive.

13.1 Marking Configuration Examples

13.1.1 Marking for Europe according to ATEX and IEC-Ex

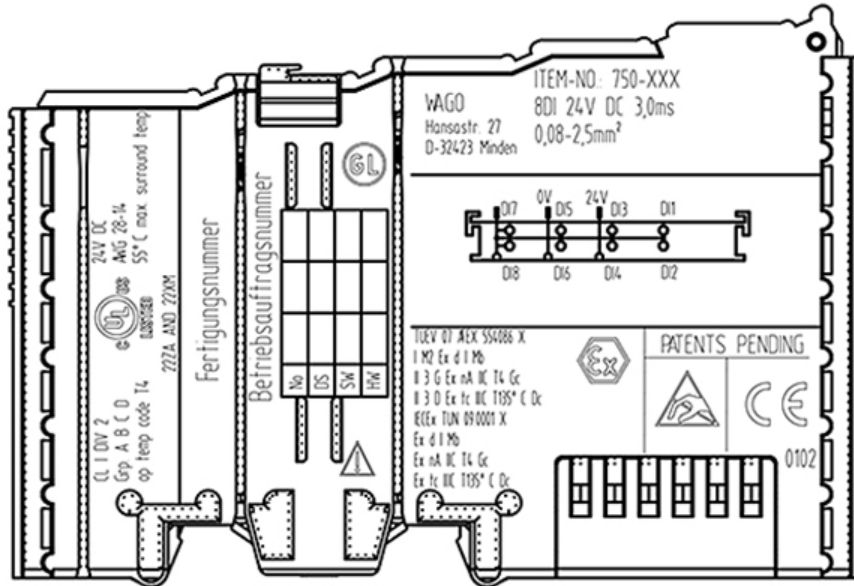

Figure 60: Side marking example for approved I/O modules according to ATEX and IECEx

TUEV 07 AEX 554086 X
I M2 Ex d I Mb
II 3 G Ex nA IIC T4 Gc
II 3 D Ex tc IIC T135° C Dc
IECEX TUN 090001 X
Ex d I Mb
Ex nA IIC T4 Gc
Ex tc IIC T135° C Dc



Figure 61: Text detail – Marking example for approved I/O modules according to ATEX and IECEx.

Table 72: Description of marking example for approved I/O modules according to ATEX and IECEx

Printing on Text	Description
TÜV 07 ATEX 554086 X IECEx TUN 09.0001 X	Approving authority and certificate numbers
Dust	
II	Equipment group: All except mining
3D	Category 3 (Zone 22)
Ex	Explosion protection mark
tc Dc	Type of protection and equipment protection level (EPL): protection by enclosure
IIIC	Explosion group of dust
T 135°C	Max. surface temperature of the enclosure (without a dust layer)
Mining	
I	Equipment group: Mining
M2	Category: High level of protection
Ex	Explosion protection mark
d Mb	Type of protection and equipment protection level (EPL): Flameproof enclosure
I	Explosion group for electrical equipment for mines susceptible to firedamp
Gases	
II	Equipment group: All except mining
3G	Category 3 (Zone 2)
Ex	Explosion protection mark
nA Gc	Type of protection and equipment protection level (EPL): Non-sparking equipment
nC Gc	Type of protection and equipment protection level (EPL): Sparking apparatus with protected contacts. A device which is so constructed that the external atmosphere cannot gain access to the interior
IIIC	Explosion group of gas and vapours
T4	Temperature class: Max. surface temperature 135°C

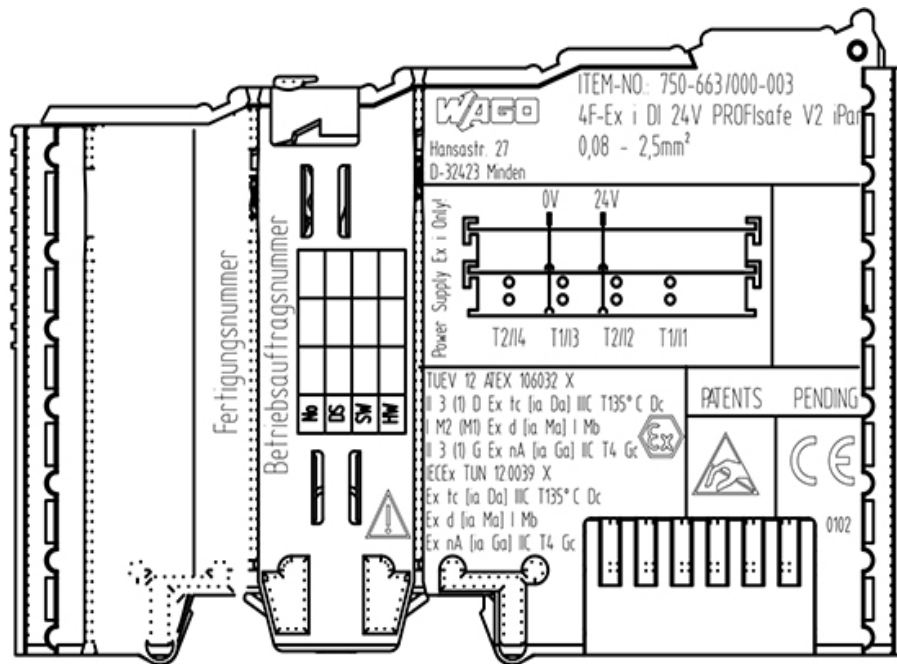

Figure 62: Side marking example for approved Ex i I/O modules according to ATEX and IECEx.

TUEV 12 ATEX 106032 X
 II 3 (1) D Ex tc [ia Da] IIC T135° C Dc
 I M2 (M1) Ex d [ia Ma] I Mb
 II 3 (1) G Ex nA [ia Ga] IIC T4 Gc 
 IECEx TUN 12.0039 X
 Ex tc [ia Da] IIC T135° C Dc
 Ex d [ia Ma] I Mb
 Ex nA [ia Ga] IIC T4 Gc

Figure 63: Text detail – Marking example for approved Ex i I/O modules according to ATEX and IECEx.

Table 73: Description of marking example for approved Ex i I/O modules according to ATEX and IECEx

Inscription text	Description
TÜV 07 ATEX 554086 X IECEX TUN 09.0001X	Approving authority and certificate numbers
TÜV 12 ATEX 106032 X IECEX TUN 12.0039 X	
Dust	
II	Equipment group: All except mining
3(1)D	Category 3 (Zone 22) equipment containing a safety device for a category 1 (Zone 20) equipment
3(2)D	Category 3 (Zone 22) equipment containing a safety device for a category 2 (Zone 21) equipment
Ex	Explosion protection mark
tc Dc	Type of protection and equipment protection level (EPL): protection by enclosure
[ia Da]	Type of protection and equipment protection level (EPL): associated apparatus with intrinsic safety circuits for use in Zone 20
[ib Db]	Type of protection and equipment protection level (EPL): associated apparatus with intrinsic safety circuits for use in Zone 21
IIIC	Explosion group of dust
T 135°C	Max. surface temperature of the enclosure (without a dust layer)
Mining	
I	Equipment Group: Mining
M2 (M1)	Category: High level of protection with electrical circuits which present a very high level of protection
Ex d Mb	Explosion protection mark with Type of protection and equipment protection level (EPL): Flameproof enclosure
[ia Ma]	Type of protection and equipment protection level (EPL): associated apparatus with intrinsic safety electrical circuits
I	Explosion group for electrical equipment for mines susceptible to firedamp

Table 73: Description of marking example for approved Ex i I/O modules according to ATEX and IECEx

Gases	
II	Equipment group: All except mining
3(1)G	Category 3 (Zone 2) equipment containing a safety device for a category 1 (Zone 0) equipment
3(2)G	Category 3 (Zone 2) equipment containing a safety device for a category 2 (Zone 1) equipment
Ex	Explosion protection mark
nA Gc	Type of protection and equipment protection level (EPL): Non-sparking equipment
[ia Ga]	Type of protection and equipment protection level (EPL): associated apparatus with intrinsic safety circuits for use in Zone 0
[ia Gb]	Type of protection and equipment protection level (EPL): associated apparatus with intrinsic safety circuits for use in Zone 1
IIC	Explosion group of gas and vapours
T4	Temperature class: Max. surface temperature 135°C

13.1.2 Marking for America according to NEC 500

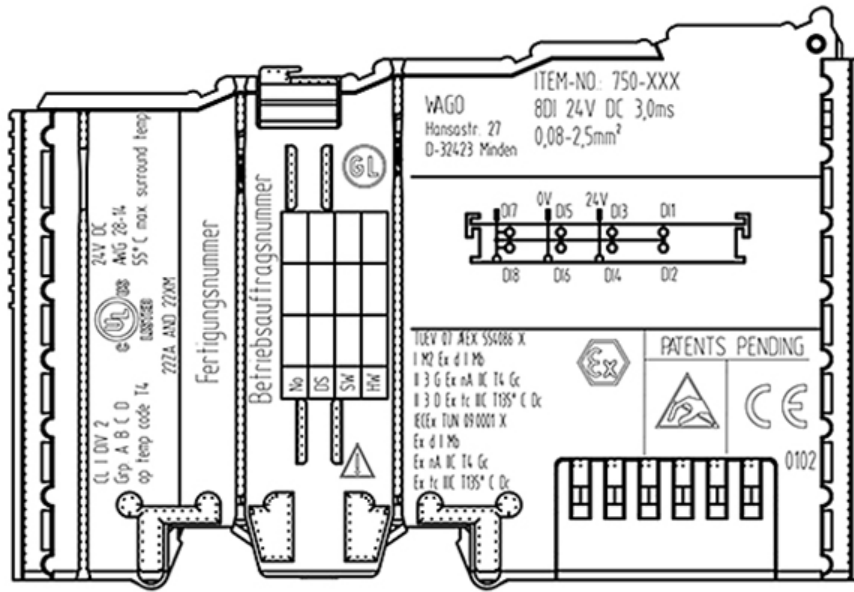

Figure 64: Side marking example for I/O modules according to NEC 500

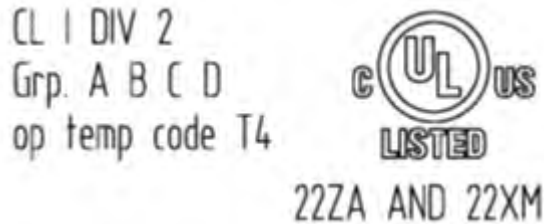

Figure 65: Text detail – Marking example for approved I/O modules according to NEC 500

Table 74: Description of marking example for approved I/O modules according to NEC 500

Printing on Text	Description
CL I	Explosion protection group (condition of use category)
DIV 2	Area of application
Grp. ABCD	Explosion group (gas group)
Op temp code T4	Temperature class

13.2 Installation Regulations

For the installation and operation of electrical equipment in hazardous areas, the valid national and international rules and regulations which are applicable at the installation location must be carefully followed.

13.2.1 Special Conditions for Safe Use (ATEX Certificate TÜV 07 ATEX 554086 X)

1. For use as Gc- or Dc-apparatus (in zone 2 or 22) the Field bus Independent I/O Modules WAGO-I/O-SYSTEM 750-*** shall be erected in an enclosure that fulfils the requirements of the applicable standards (see the marking) EN 60079-0, EN 60079-11, EN 60079-15 and EN 60079-31. For use as group I electrical apparatus M2 the apparatus shall be erected in an enclosure that ensures a sufficient protection according to EN 60079-0 and EN 60079-1 and the degree of protection IP64. The compliance of these requirements and the correct installation into an enclosure or a control cabinet of the devices shall be certified by an ExNB.
2. Measures have to be taken outside of the device that the rating voltage is not being exceeded of more than 40 % because of transient disturbances.
3. Dip-switches, binary-switches and potentiometers, connected to the module may only be actuated when explosive atmosphere can be excluded.
4. The connecting and disconnecting of the non-intrinsically safe circuits is only permitted during installation, for maintenance or for repair purposes. The temporal coincidence of explosion hazardous atmosphere and installation, maintenance resp. repair purposes shall be excluded. This is although and in particular valid for the interfaces “Memory-Card”, “USB”, “Fieldbus connection”, “Configuration and programming interface”, “antenna socket”, “D-Sub”, “DVI-port” and the “Ethernet interface”. These interfaces are not energy limited or intrinsically safe circuits. An operating of those circuits is in the behalf of the operator.
5. For the types 750-606, 750-625/000-001, 750-487/003-000, 750-484 and 750-633 the following shall be considered: The Interface circuits shall be limited to overvoltage category I/II/III (non mains/mains circuits) as defined in EN 60664-1.
6. For replaceable fuses the following shall be considered: Do not remove or replace the fuse when the apparatus is energized.
7. The following warnings shall be placed nearby the unit:
WARNING – DO NOT REMOVE OR REPLACE FUSE WHEN ENERGIZED
WARNING – DO NOT SEPARATE WHEN ENERGIZED
WARNING – SEPARATE ONLY IN A NON-HAZARDOUS AREA

13.2.2 Special Conditions for Safe Use (ATEX Certificate TÜV 12 ATEX 106032 X)

1. For use as Gc- or Dc-apparatus (in zone 2 or 22) the Field bus Independent I/O Modules WAGO-I/O-SYSTEM 750-*** Ex i shall be erected in an enclosure that fulfils the requirements of the applicable standards (see the marking) EN 60079-0, EN 60079-11, EN 60079-15 and EN 60079-31. For use as group I electrical apparatus M2 the apparatus shall be erected in an enclosure that ensures a sufficient protection according to EN 60079-0 and EN 60079-1 and the degree of protection IP64. The compliance of these requirements and the correct installation into an enclosure or a control cabinet of the devices shall be certified by an ExNB.
2. Measures have to be taken outside of the device that the rating voltage is not being exceeded of more than 40 % because of transient disturbances.
3. The connecting and disconnecting of the non-intrinsically safe circuits is only permitted during installation, for maintenance or for repair purposes. The temporal coincidence of explosion hazardous atmosphere and installation, maintenance resp. repair purposes shall be excluded.
4. For the type the following shall be considered: The Interface circuits shall be limited to overvoltage category I/II/III (non mains/mains circuits) as defined in EN 60664-1.

13.2.3 Special Conditions for Safe Use (IEC-Ex Certificate TUN 09.0001 X)

1. For use as Gc- or Dc-apparatus (in zone 2 or 22) the Field bus Independent I/O Modules WAGO-I/O-SYSTEM 750-*** shall be erected in an enclosure that fulfils the requirements of the applicable standards (see the marking) IEC 60079-0, IEC 60079-11, IEC 60079-15 and IEC 60079-31. For use as group I electrical apparatus M2 the apparatus shall be erected in an enclosure that ensures a sufficient protection according to IEC 60079-0 and IEC 60079-1 and the degree of protection IP64.
The compliance of these requirements and the correct installation into an enclosure or a control cabinet of the devices shall be certified by an ExCB.
2. Measures have to be taken outside of the device that the rating voltage is not being exceeded of more than 40 % because of transient disturbances.
3. DIP-switches, binary-switches and potentiometers, connected to the module may only be actuated when explosive atmosphere can be excluded.
4. The connecting and disconnecting of the non-intrinsically safe circuits is only permitted during installation, for maintenance or for repair purposes. The temporal coincidence of explosion hazardous atmosphere and installation, maintenance resp. repair purposes shall be excluded. This is although and in particular valid for the interfaces “Memory-Card”, “USB”, “Fieldbus connection”, “Configuration and programming interface”, “antenna socket”, “D-Sub”, “DVI-port” and the “Ethernet interface”. These interfaces are not energy limited or intrinsically safe circuits. An operating of those circuits is in the behalf of the operator.
5. For the types 750-606, 750-625/000-001, 750-487/003-000, 750-484 and 750-633 the following shall be considered: The Interface circuits shall be limited to overvoltage category I/II/III (non mains/mains circuits) as defined in IEC 60664-1.
6. For replaceable fuses the following shall be considered: Do not remove or replace the fuse when the apparatus is energized.
7. The following warnings shall be placed nearby the unit:
WARNING – DO NOT REMOVE OR REPLACE FUSE WHEN ENERGIZED
WARNING – DO NOT SEPARATE WHEN ENERGIZED
WARNING – SEPARATE ONLY IN A NON-HAZARDOUS AREA

13.2.4 Special Conditions for Safe Use (IEC-Ex Certificate IECEx TUN 12.0039 X)

1. For use as Gc- or Dc-apparatus (in zone 2 or 22) the Field bus independent I/O Modules WAGO-I/O-SYSTEM 750-*** Ex i shall be erected in an enclosure that fulfils the requirements of the applicable standards (see the marking) IEC 60079-0, IEC 60079-11, IEC 60079-15, IEC 60079-31.
For use as group I electrical apparatus M2 the apparatus shall be erected in an enclosure that ensures a sufficient protection according to IEC 60079-0 and IEC 60079-1 and the degree of protection IP64.
The compliance of these requirements and the correct installation into an enclosure or a control cabinet of the devices shall be certified by an ExCB.
2. Measures have to be taken outside of the device that the rating voltage is not being exceeded of more than 40 % because of transient disturbances.
3. The connecting and disconnecting of the non-intrinsically safe circuits is only permitted during installation, for maintenance or for repair purposes.
The temporal coincidence of explosion hazardous atmosphere and installation, maintenance resp. repair purposes shall be excluded.
4. For the type the following shall be considered: The Interface circuits shall be limited to overvoltage category I/II/III (non mains/mains circuits) as defined in IEC 60664-1.

13.2.5 Special Conditions for Safe Use according to ANSI/ISA 12.12.01

- A. “This equipment is suitable for use in Class I, Division 2, Groups A, B, C, D or non-hazardous locations only.”
- B. “This equipment is to be fitted within tool-secured enclosures only.”
- C. “WARNING Explosion hazard - substitution of components may impair suitability for Class I, Div. 2.”
- D. “WARNING – Do not disconnect equipment unless power has been switched off or the area is known to be non-hazardous” has to be placed near each operator accessible connector and fuse holder.
- E. When a fuse is provided, the following information shall be provided: “A switch suitable for the location where the equipment is installed shall be provided to remove the power from the fuse.”
- F. For devices with EtherCAT/Ethernet connectors “Only for use in LAN, not for connection to telecommunication circuits.”
- G. “WARNING - Use Module 750-642 only with antenna module 758-910.”
- H. For Couplers/Controllers and Economy bus modules only: The instructions shall contain the following: “The configuration interface Service connector is for temporary connection only. Do not connect or disconnect unless the area is known to be non-hazardous. Connection or disconnection in an explosive atmosphere could result in an explosion.”
- I. Modules containing fuses only: “WARNING - Devices containing fuses must not be fitted into circuits subject to over loads, e.g. motor circuits.”
- J. Modules containing SD card reader sockets only: “WARNING - Do not connect or disconnect SD-Card while circuit is live unless the area is known to be free of ignitable concentrations of flammable gases or vapors.”

Information



Additional Information

Proof of certification is available on request.

Also take note of the information given on the operating and assembly instructions.

The manual, containing these special conditions for safe use, must be readily available to the user.

14 Appendix

14.1 Module and Submodule types of the I/O-Modules

14.1.1 Digital Input Modules

The module/submodule types are listed for the digital input modules and the substitute I/O modules assigned in the tables below.

The subsequent tables for the submodule types and data lengths list the number of data bits allocated in the respective process image for the individual submodules (in bytes) and furnished with information (in bits).

The respective number of bytes of the telegrams in the send and receive direction is also specified as input IOD→IOC (provider) and output IOC→IOD (consumer).

The group of digital input modules is divided into eight module types.

Table 75: Module types – Digital Input Modules

Module type	Description	Substitute I/O modules
1DI, DIA	1-Channel Digital Input Modules, 1 bit diagnostics	75x-435
2DI	2-Channel Digital Input Modules	75x-400, 75x-401, 75x-405, 75x-406, 75x-407, 75x-410, 75x-411, 75x-412, 75x-413, 75x-416, 75x-427, 75x-429, 75x-438
2DI, DIA	2-Channel Digital Input Modules, 1 bit diagnostics per channel	75x-419, 75x-421, 75x-425
2DI, DIA, Ackn.	2-Channel Digital Input Modules, 1 bit diagnostics per channel, 1 bit diagnostics confirmation per channel	75x-418
4DI	4-Channel Digital Input Modules	75x-402, 75x-403, 75x-408, 75x-409, 75x-414, 75x-415, 75x-422, 75x-423, 75x-424, 75x-428, 75x-432, 75x-433, 75x-440, 75x-1420, 75x-1421, 75x-1422, 75x-1423
8DI	8-Channel Digital Input Modules	75x-430, 75x-431, 75x-434, 75x-436, 75x-437, 75x-1415, 75x-1416, 75x-1417, 75x-1418
8DI, DIA, DIA DIS	8-Channel Digital Input Modules, 1 bit diagnostics per channel, 1 bit diagnostics disabling per channel	750-439
8DI, DIA, DI DIS	8-Channel Digital Input Modules, 1 bit diagnostics per channel, 1 bit input disabling per channel	750-1425
16DI	16-Channel Digital Input Modules	750-1400, 750-1402, 75x-1405 75x-1406, 75x-1407, 75x-1408

Digital input modules receive the consumer status (IOCS) as process data

qualifiers from the IO controller and supply it with the provider status (IOPS) of the existing input and optional diagnostic information.

Table 76: Submodule types and data lengths – Digital Input Modules

PNIO module type		Process data length [byte]/ allocation [bit]				Telegram allocation [byte]	
PNIO submodule type	Data type	Input (I-PI)		Output (O-PI)		Input	Output
1DI, DIA							
1DI (+30 BIT I), DIA in I-PI	OctetString[1], bit field	1	2	0	0	2	1
1DI (+14 BIT I), DIA in I-PI	OctetString[2], bit field	2	2	0	0	3	1
1DI (+ 6 BIT I), DIA in I-PI	OctetString[4], bit field	4	2	0	0	5	1
1DI (- 2 BIT I), DIA in I-PI	-	0	2	0	0	1	1
2DI							
2DI (+ 6 BIT I)	OctetString[1], bit field	1	2	0	0	2	1
2DI (+14 BIT I)	OctetString[2], bit field	2	2	0	0	3	1
2DI (+30 BIT I)	OctetString[4], bit field	4	2	0	0	5	1
2DI (- 2 BIT I)	-	0	2	0	0	1	1
2DI, DIA							
2DI (+ 6 BIT I)	OctetString[1], bit field	1	2	0	0	2	1
2DI (+14 BIT I)	OctetString[2], bit field	2	2	0	0	3	1
2DI (+30 BIT I)	OctetString[4], bit field	4	2	0	0	5	1
2DI (- 2 BIT I)	-	0	2	0	0	1	1
2DI (+ 4 BIT I), DIA in I-PI	OctetString[1], bit field	1	4	0	0	2	1
2DI (+12 BIT I), DIA in I-PI	OctetString[2], bit field	2	4	0	0	3	1
2DI (+28 BIT I), DIA in I-PI	OctetString[4], bit field	4	4	0	0	5	1
2DI (- 4 BIT I), DIA in I-PI	-	0	4	0	0	1	1
2DI, DIA, Ackn.							
2DI (+ 6 BIT I/O), DIA, Ackn.	OctetString[1], bit field	1	2	1	2	3	3
2DI (+14 BIT I/O), DIA, Ackn.	OctetString[2], bit field	2	2	2	2	4	4
2DI (+30 BIT I/O), DIA, Ackn.	OctetString[4], bit field	4	2	4	2	6	6
2DI (- 2 BIT I/O), DIA, Ackn.	-	0	2	0	2	1	1
2DI (+ 4 BIT I, +6 Bit A), DIA in I-PI, Ackn.	OctetString[1], bit field	1	4	1	2	3	3
2DI (+12 BIT I, +14 BIT O), DIA in I-PI, Ackn.	OctetString[2], bit field	2	4	2	2	4	4
2DI (- 4 BIT I, - 2 BIT O), DIA in I-PI, Ackn.	OctetString[4], bit field	4	4	4	2	6	6

Table 76: Submodule types and data lengths – Digital Input Modules

PNIO module type		Process data length [byte]/ allocation [bit]				Telegram allocation [byte]	
PNIO submodule type	Data type	Input (I-PI)		Output (O-PI)		Input	Output
4DI							
4DI (+ 4 BIT I)	OctetString[1], bit field	1	4	0	0	2	1
4DI (+12 BIT I)	OctetString[2], bit field	2	4	0	0	3	1
4DI (+28 BIT I)	OctetString[4], bit field	4	4	0	0	5	1
4DI (- 4 BIT I)	-	0	4	0	0	1	1
8DI							
8DI	OctetString[1], bit field	1	8	0	0	2	1
8DI (+ 8 BIT I)	OctetString[2], bit field	2	8	0	0	3	1
8DI (+24 BIT I)	OctetString[4], bit field	4	8	0	0	5	1
8DI (- 8 BIT I)	-	0	8	0	0	1	1
8DI, DIA, DIA DIS							
8DI, DIA, DIA DIS	OctetString[1], bit field	1	8	0	0	3	3
8DI (+ 8 BIT I/O), DIA, DIA DIS	OctetString[2], bit field	2	8	1	0	4	4
8DI (+24 BIT I/O), DIA, DIA DIS	OctetString[4], bit field	4	8	4	8	6	6
8DI (- 8 BIT I/O), DIA, DIA DIS	-	0	8	0	8	1	1
8DI (+ 8 BIT O), DIA in I-PI, DIA DIS	OctetString[2], bit field	2	16	1	8	4	4
8DI (+16 BIT I, +24 BIT O), DIA in I-PI, DIA DIS	OctetString[4], bit field	4	16	4	8	6	6
8DI (-16 BIT I, - 8 BIT O), DIA in I-PI, DIA DIS	-	0	16	0	8	1	1
8DI, DIA, DI DIS							
8DI, DIA, DI DIS	OctetString[1], Bitfeld	1	8	0	0	3	3
8DI (+ 8 BIT I/O), DIA, DI DIS	OctetString[2], Bitfeld	2	8	1	0	4	4
8DI (+24 BIT I/O), DIA, DI DIS	OctetString[4], Bitfeld	4	8	4	8	6	6
8DI (- 8 BIT I/O), DIA, DI DIS	-	0	8	0	8	1	1
8DI (+ 8 BIT O), DIA in I-PI, DI DIS	OctetString[2], Bitfeld	2	16	1	8	4	4
8DI (+16 BIT I, +24 BIT O), DIA in I-PI, DI DIS	OctetString[4], Bitfeld	4	16	4	8	6	6

Table 76: Submodule types and data lengths – Digital Input Modules

PNIO module type		Process data length [byte]/ allocation [bit]				Telegram allocation [byte]	
PNIO submodule type	Data type	Input (I-PI)		Output (O-PI)		Input	Output
8DI (-16 BIT I, - 8 BIT O), DIA in I-PI, DI DIS	-	0	16	0	8	1	1
16DI							
16DI	OctetString[2], bit field	2	16	0	0	3	1
16DI (+16 BIT I)	OctetString[4], bit field	4	16	0	0	5	1
16DI (-16 BIT I)	-	0	16	0	0	1	1

14.1.2 Digital Output Modules

The module/submodule types are listed for the digital output modules and the substitute I/O modules assigned in the tables below.

The subsequent tables for the submodule types and data lengths list the number of data bits allocated in the respective process image for the individual submodules (in bytes) and furnished with information (in bits).

The respective number of bytes of the telegrams in the send and receive direction is also specified as input IOD→IOC (provider) and output IOC→IOD (consumer).

The group of digital output modules is divided into eight module types.

Table 77: Module types – Digital Output Modules

Module type	Description	Substitute I/O modules
2DO	2-Channel Digital Output Modules	75x-501, 75x-502, 75x-509, 75x-512, 75x-513, 75x-514, 75x-517, 75x-535
2DO, DIA	2 (1)-Channel Digital Output Modules, 1 bit diagnostics per signal channel	75x-507, 75x-508, 75x-522, 75x-523 (1 DO)
2DO, DIA	2-Channel Digital Output Modules, 2 bits diagnostics per signal channel	75x-506
4DO	4-Channel Digital Output Modules	75x-504, 75x-516, 75x-519 75x-531, 75x-540
4DO, DIA	4-Channel Digital Output Modules, 1 bit diagnostics per signal channel	75x-532
8DO	8-Channel Digital Output Modules	75x-530, 75x-534, 75x-536, 75x-1515, 75x-1516
8DO, DIA	8-Channel Digital Output Modules, 1 bit diagnostics per signal channel	75x-537
16DO	16-Channel Digital Output Modules	750-1500, 750-1501, 75x-1504, 75x-1505

Digital output modules without diagnostics information in the input process image receive the provider status (IOPS) from the IO controller and supply it with the consumer status (IOC) of the existing output information.

The process data qualifiers are also transmitted in the opposite direction should the diagnostics of the respective modules appear in the process image of the inputs of the IO controller.

Table 78: Submodule types and data lengths – Digital Output Modules

PNIO module type		Process data length [byte]/ allocation [bit]				Telegram allocation [byte]	
PNIO submodule type	Data type	Input (I-PI)		Output (O-PI)		Input	Output
2DO							
2DO (+ 6 BIT O), DIA	OctetString[1], bit field	0	0	1	2	1	2
2DO (+14 BIT O), DIA	OctetString[2], bit field	0	0	2	2	1	3
2DO (+30 BIT O), DIA	OctetString[4], bit field	0	0	4	2	1	5
2DO (- 2 BIT O), DIA	-	0	0	0	2	1	1
2DO, PE	OctetString[1], bit field	0	0	1	8	1	2
2DO, DIA (75x-506, 75x-507, 75x-508)							
2DO (+ 6 BIT O), DIA	OctetString[1], bit field	0	0	1	2	1	2
2DO (+14 BIT O), DIA	OctetString[2], bit field	0	0	2	2	1	3
2DO (+30 BIT O), DIA	OctetString[4], bit field	0	0	4	2	1	5
2DO (- 2 BIT O), DIA	-	0	0	0	2	1	1
2DO, DIA, PE	OctetString[1], bit field	0	0	1	8	1	2
2DO (+ 6 BIT I/O), DIA in I-PI	OctetString[1], bit field	1	2	1	2	3	3
2DO (+14 BIT I/O) DIA in I-PI	OctetString[2], bit field	2	2	2	2	4	4
2DO (+30 BIT I/O) DIA in I-PI	OctetString[4], bit field	4	2	4	2	6	6
2DO (- 2 BIT I/O) DIA in I-PI	-	0	2	0	2	1	1
2DO, DIA in I-PI, PE	OctetString[1], bit field	1	8	1	8	3	3
2DO, DIA (75x-506) additionally							
2DO (+ 6 BIT O, + 4 BIT I), DIA in I-PI	OctetString[1], bit field	1	4	1	2	3	3
2DO (+14 BIT O, +12 BIT I), DIA in I-PI	OctetString[2], bit field	2	4	2	2	4	4
2DO (+30 BIT O, +28 BIT I), DIA in I-PI	OctetString[4], bit field	4	4	4	2	6	6
2DO (- 2 BIT O, - 4 BIT I), DIA in I-PI	-	0	4	0	2	1	1
4DO							
4DO (+ 4 BIT O)	OctetString[1], bit field	0	0	1	4	1	2
4DO (+12 BIT O)	OctetString[2], bit field	0	0	2	4	1	3

Table 78: Submodule types and data lengths – Digital Output Modules

PNIO module type		Process data length [byte]/ allocation [bit]				Telegram allocation [byte]	
PNIO submodule type	Data type	Input (I-PI)		Output (O-PI)		Input	Output
4DO (+28 BIT O)	OctetString[4], bit field	0	0	4	4	1	5
4DO (- 4 BIT O)	-	0	0	0	4	1	1
4DO, PE	OctetString[1], bit field	0	0	1	8	1	2
4DO, DIA (75x-532)							
4DO (+ 4 BIT O), DIA	OctetString[1], bit field	0	0	1	4	1	2
4DO (+12 BIT O), DIA	OctetString[2], bit field	0	0	2	4	1	3
4DO (+28 BIT O), DIA	OctetString[4], bit field	0	0	4	4	1	5
4DO (- 4 BIT O), DIA	-	0	0	0	4	1	1
4DO, DIA, PE	OctetString[1], bit field	0	0	1	8	1	2
4DO (+ 4 BIT I/O), DIA in I-PI	OctetString[1], bit field	4	4	1	4	3	3
4DO (+12 BIT I/O), DIA in I-PI	OctetString[2], bit field	2	4	2	4	4	4
4DO (+28 BIT I/O), DIA in I-PI	OctetString[4], bit field	4	4	4	4	6	6
4DO (- 4 BIT I/O), DIA in I-PI	-	0	4	0	4	1	1
4DO, DIA in I-PI, PE	OctetString[1], bit field	1	8	1	8	3	3
8DO							
8DO	OctetString[1], bit field	0	0	1	8	1	2
8DO (+ 8 BIT O)	OctetString[2], bit field	0	0	2	8	1	3
8DO (+24 BIT O)	OctetString[4], bit field	0	0	4	8	1	5
8DO (- 8 BIT O)	-	0	0	0	8	1	1
8DO, PE	OctetString[1], bit field	0	0	1	8	1	2
8DO, DIA							
8DO, DIA	OctetString[1], bit field	0	0	1	8	1	2
8DO (+ 8 BIT O), DIA	OctetString[2], bit field	0	0	2	8	1	3
8DO (+24 BIT O), DIA	OctetString[4], bit field	0	0	4	8	1	5
8DO (- 8 BIT O), DIA	-	0	0	0	8	1	1
8DO, DIA, PE	OctetString[1], bit field	0	0	1	8	1	2
8DO, DIA in I-PI	OctetString[1], bit field	1	8	1	8	3	3

Table 78: Submodule types and data lengths – Digital Output Modules

PNIO module type		Process data length [byte]/ allocation [bit]				Telegram allocation [byte]	
PNIO submodule type	Data type	Input (I-PI)		Output (O-PI)		Input	Output
8DO (+ 8 BIT I/O), DIA in I-PI	OctetString[2], bit field	2	8	2	8	4	4
8DO (+24 BIT I/O), DIA in I-PI	OctetString[4], bit field	4	8	4	8	6	6
8DO (- 8 BIT I/O), DIA in I-PI	-	0	8	0	8	1	1
8DO, DIA in I-PI, PE	OctetString[1], bit field	1	8	1	8	3	3
16DO							
16DO	OctetString[2], bit field	0	0	2	16	1	3
16DO (+16 BIT O)	OctetString[4], bit field	0	0	4	16	1	5
16DO (-16 BIT O)	-	0	0	0	16	1	1
16DO, PE	OctetString[2], bit field	0	0	2	16	1	3

14.1.3 Digital Input/Output Modules

The module/submodule types are listed for the digital input/output modules and the substitute I/O modules assigned in the tables below.

The subsequent tables for the submodule types and data lengths list the number of data bits allocated in the respective process image for the individual submodules (in bytes) and furnished with information (in bits).

The respective number of bytes of the telegrams in the send and receive direction is also specified as input IOD→IOC (provider) and output IOC→IOD (consumer).

There is one module type for the digital input / output modules.

Table 79: Module types – Digital Input/Output Modules

Module type	Description	Substitute I/O modules
8DIO	8-Channel Digital Input/Output Modules	75x-1502, 75x-1506

Digital input/output modules receive the provider status (IOPS) of the available output information as well as the consumer status (IOCS) of the received input information from the IO controller. They provide the IO controller with the consumer status (IOCS) of the received output information as well as the provider status (IOPS) of the available input information.

Table 80: Submodule types and data lengths – Digital Input/Output Modules

PNIO module type		Process data length [byte]/ allocation [bit]				Telegram allocation [byte]	
PNIO submodule type	Data type	Input (I-PI)		Output (O-PI)		Input	Output
8DIO							
8DIO	OctetString[1], bit field	1	8	1	8	3	3
8DIO (+ 8 BIT I/O)	OctetString[2], bit field	2	8	2	8	4	4
8DIO (+24 BIT I/O)	OctetString[4], bit field	4	8	4	8	6	6
8DIO (- 8 BIT I/O)	-	0	8	0	8	1	1
8DIO, PE	OctetString[1], bit field	1	8	1	8	3	3

14.1.4 Analog Input Modules

The module/submodule types are listed for the analog input modules and the substitute I/O modules assigned in the tables below.

The subsequent tables for the submodule types and data lengths list the number of data bytes provided in the respective process image for the individual submodules. The respective number of bytes of the telegrams in the send and receive direction is also specified as input IOD→IOC (provider) and output IOC→IOD (consumer).

The group of analog input modules is divided into three module types, which are divided into five submodule types.

Table 81: Module types – Analog Input Modules

Module type	Description	Substitute I/O modules
2AI	2-Channel Analog Input Modules, 16 bits input data per signal channel	75x-452, 75x-454, 75x-456, 75x-461, 75x-462, 75x-464, 75x-465, 75x-466, 75x-467, 75x-469, 75x-470, 75x-472, 75x-473, 75x-474, 75x-475, 75x-476, 75x-477, 75x-478, 75x-479, 75x-480, 75x-481, 75x-483, 75x-485, 75x-487, 75x-491, 75x-492, plus all variations
3AI	3-Channel Analog Input Modules, 16 bits input and output data plus control byte and status byte per signal channel, access to the register structure via cyclic data exchange	75x-493, plus all variations
4AI	4-Channel Analog Input Modules, 16 bits input data per signal channel	75x-450, 75x-453, 75x-455, 75x-457, 75x-459, 75x-460, 75x-464, 75x-468, plus all variations
8AI	8-Channel Analog Input Modules, 16 bits input data per signal channel	75x-451 plus all variations
3PMM	3-Phase Power Measurement Module, 16/32 bits data composition	75x-494, 75x-495 plus all variations

Analog input modules receive the consumer status (IOCS) from the I/O controller and supply it with the provider status (IOPS) of the existing input information if only the actual user data is replaced. If all existing information is available in the process image of the inputs and outputs, the process data qualifiers are also transmitted in the opposite direction.

Table 82: Submodule types and data lengths – Analog Input Modules

PNIO module type		Process data length [byte]/ allocation [bit]		Telegram allocation [byte]	
PNIO submodule type	Data type	Input (I-PI)	Output (O-PI)	Input	Output
2AI					
INT16[2] I	Integer16	4	0	5	1
{UINT8, INT16}[2] I/O	{Unsigned8, Integer16}	6	6	8	8
2AI HART (from FW 03)					
{INT16, FLOAT32}[2] I	{Integer16, Float32}	12	0	13	1
{INT16, FLOAT32[2]}[2] I	{Integer16, Float32[2]}	20	0	21	1
{INT16, FLOAT32[3]}[2] I	{Integer16, Float32[3]}	28	0	29	1
{INT16, FLOAT32[4]}[2] I	{Integer16, Float32[4]}	36	0	37	1
3AI					
{UINT8, UINT8, INT16}[8] I/O	{Unsigned8, Unsigned8, Integer16}	12	12	14	14
4AI					
INT16[4] I	Integer16	8	0	9	1
{UINT8, INT16}[4] I/O	{Unsigned8, Integer16}	12	12	14	14
8AI					
INT16[8] I	Integer16	16	0	17	1
{UINT8, INT16}[8] I/O	{Unsigned8, Integer16}	24	24	26	26
3PMM					
{UINT8, INT8[23]} I/O	{Unsigned8, Unsigned8[23] }	24	24	26	26

14.1.5 Analog Output Modules

The module/submodule types are listed for the analog output modules and the substitute I/O modules assigned in the tables below.

The subsequent tables for the submodule types and data lengths list the number of data bytes provided in the respective process image for the individual submodules. The respective number of bytes of the telegrams in the send and receive direction is also specified as input IOD→IOC (provider) and output IOC→IOD (consumer).

The group of analog output modules has two module types divided into four submodule types.

Table 83: Module types – Analog Output Modules

Module type	Description	Substitute I/O modules
2AO	2-Channel Analog Output Modules, 16 bits output data per signal channel	75x-550, 75x-552, 75x-554, 75x-556, 75x-560, 75x-562, 75x-563, 75x-585, plus all variations
4AO	4-Channel Analog Output Modules, 16 bits output data per signal channel	75x-553, 75x-555, 75x-557, 75x-559, plus all variations

Analog output modules receive the provider status (IOPS) from the I/O controller and supply it with the consumer status (IOCS) of the existing output information if only the actual user data is replaced. If all existing information is available in the process image of the inputs and outputs, the process data qualifiers are also transmitted in the opposite direction.

Table 84: Submodule types and data lengths – Analog Output Modules

PNIO module type		Process data length [byte]/ allocation [bit]		Telegram allocation [byte]	
PNIO submodule type	Data type	Input (I-PI)	Output (O-PI)	Input	Output
2AO					
INT16[2] O	Integer16	0	4	1	5
{UINT8, INT16}[2] I/O	{Unsigned8, Integer16}	6	6	8	8
4AO					
INT16[4] O	Integer16	0	8	1	9
{UINT8, INT16}[4] I/O	{Unsigned8, Integer16}	12	12	14	14

14.1.6 Specialty Modules

The module/submodule types are listed for the special-purpose modules and the substitute I/O modules assigned in the tables below.

The subsequent tables for the submodule types and data lengths list the number of data bytes provided in the respective process image for the individual submodules. The respective number of bytes of the telegrams in the send and receive direction is also specified as input IOD→IOC (provider) and output IOC→IOD (consumer).

14.1.6.1 Up/Down Counter

The group of up/down counters has two module types divided into three submodule types.

Table 85: Module types – Up/Down Counter

Module type	Description	Substitute I/O modules
1(2)CNT	1(2)-Channel Up/Down Counter, 32(16) bits input and output data plus control byte and status byte per signal channel, Access to the register structure via cyclic data exchange	75x-404, 75x-633, plus all variations
2CNT	2- Channel Up/Down Counter, 16 bits input and output data plus control byte and status byte per signal channel, Access to the register structure via cyclic data exchange	75x-638

For up/down counters, provider and consumer status (IOPS, IOCS) of the input or output information are exchanged between the IO controller and IO device in both directions.

Table 86: Submodule types and data lengths – Up/Down Counter

PNIO module type		Process data length [byte]/ allocation [bit]		Telegram allocation [byte]	
PNIO submodule type	Data type	Input (I-PI)	Output (O-PI)	Input	Output
1(2)CNT					
{UINT8, UINT8, UINT32} I/O	{Unsigned8, Unsigned8, Unsigned32}	6	6	8	8
{UINT8, UINT8, UINT16[2]} I/O	{Unsigned8, Unsigned8, Unsigned16[2]}	6	6	8	8
2CNT					
{UINT8, UINT16}[2] I/O	{Unsigned8, Unsigned16}	6	6	8	8

14.1.6.2 2-Channel Pulse Width Modules

The group of 2-channel pulse width output module has one module type divided into two submodule types.

Table 87: Module types – 2-Channel Pulse Width Output Modules

Module type	Description	Substitute I/O modules
2PWM	2-Channel Pulse Width Output Modules, 16 bits output data per signal channel	75x-511, plus all variations

Pulse width output modules receive the provider status (IOPS) from the IO controller and supply it with the consumer status (IOCS) of the received output information in case only the actual user data is exchanged. If all existing information is available in the process image of the inputs and outputs, the process data qualifiers are also transmitted in the opposite direction.

Table 88: Submodule types and data lengths – 2-Channel Pulse Width Output Module

PNIO module type		Process data length [byte]/ allocation [bit]		Telegram allocation [byte]	
PNIO submodule type	Data type	Input (I-PI)	Output (O-PI)	Input	Output
2PWM					
INT16[2] O	Integer16	0	4	1	5
{UINT8, INT16}[2] I/O	{Unsigned8, Unsigned16}	6	6	8	8

14.1.6.3 Distance and Angle Measurement Modules

The group of distance and angle measurement modules includes three module types:

Table 89: Module types – Distance and Angle Measurement Modules

Module type	Description	Substitute I/O modules
1SSI	SSI Transmitter Interface, 32 bits input data	75x-630, plus all variations
Module type	Description	Substitute I/O modules
1ENC	Incremental Encoder Interface, 32 bits input and output data plus control byte and status byte per signal channel, access to the register structure via cyclic data exchange	75x-631, 75x-634, 75x-637, plus all variations
Module type	Description	Substitute I/O modules
1DII	Digital Impulse Interface, 24 bits input and output data plus control byte and status byte per signal channel, access to the register structure via cyclic data exchange	75x-635

For the distance and angle measurement modules, the provider and consumer status (IOPS, IOCS) of the input or output information are exchanged between the IO controller and IO device in both directions. With the SSI interface 75x-630, there is also an option to transmit the input data of the transmitter only.

In this case, the IO device only receives the consumer status (IOCS) from the IO controller and supplies it with the provider status (IOPS) of the available input data.

Table 90: Submodule types and data lengths – Distance and Angle Measurement Modules

PNIO module type		Process data length [byte]/ allocation [bit]		Telegram allocation [byte]	
PNIO submodule type	Data type	Input (I-PI)	Output (O-PI)	Input	Output
1SSI					
UINT32 I	Unsigned32	4	0	5	1
{UINT8, UINT8, UINT32} I/O	{Unsigned8, Unsigned8, Unsigned32}	6	6	8	8
1ENC					
{UINT8, INT16} I/O	{Unsigned8, Integer16}	6	6	8	8
1DII					
{UINT8, UINT8[3]} I/O	{Unsigned8, Unsigned8[3]}	4	4	6	6

14.1.6.4 Serial Interfaces

The group of serial interfaces has two module types divided into seven submodule types.

Table 91: Modultypen – Serial Interfaces

Module type	Description	Substitute I/O modules
1SER	Serial Interfaces	75x-650, 75x-651, 75x-653, 75x-652, plus all variations
Module type	Description	Substitute I/O modules
DXCH	Data Exchange Modules	75x-654

For the serial interfaces, the provider and consumer status (IOPS, IOCS) of the input or output information are exchanged between the IO controller and IO device in both directions.

Table 92: Submodule types and data lengths – Serial Interfaces

PNIO module type		Process data length [byte]/ allocation [bit]		Telegram allocation [byte]	
PNIO submodule type	Data type	Input (I-PI)	Output (O-PI)	Input	Output
1SER					
{UINT8, UINT8[3]} I/O	{Unsigned8, Unsigned8[3]}	4	4	6	6
{UINT8, UINT8[5]} I/O	{Unsigned8, Unsigned8[5]}	6	6	8	8
{UINT8, UINT8, UINT8[6]} I/O	{Unsigned8, Unsigned8, Unsigned8[6]}	8	8	10	10
{UINT8, UINT8, UINT8[22]} I/O	{Unsigned8, Unsigned8, Unsigned8[22]}	24	24	26	26

Table 92: Submodule types and data lengths – Serial Interfaces

PNIO module type		Process data length [byte]/ allocation [bit]		Telegram allocation [byte]	
PNIO submodule type	Data type	Input (I-PI)	Output (O-PI)	Input	Output
{UINT8, UINT8, UINT8[46]} I/O	{Unsigned8, Unsigned8, Unsigned8[46]}	48	48	50	50
DXCH					
{UINT8, UINT8[3]} I/O	{Unsigned8, Unsigned8[3]}	4	4	6	6
{UINT8, UINT8[5]} I/O	{Unsigned8, Unsigned8[5]}	6	6	8	8

14.1.6.5 DC-Drive Controller

The group of DC drive controllers has one module and one submodule type.

Table 93: Module types – DC-Drive Controller

Module type	Description	Substitute I/O modules
DC-Drive	DC-Drive Controller	75x-636, plus all variations

For the DC drive controller, the provider and consumer status (IOPS, IOCS) of the input or output information are exchanged between the IO controller and IO device in both directions.

Table 94: Submodule types and data lengths – DC-Drive Controller

PNIO module type		Process data length [byte]/ allocation [bit]		Telegram allocation [byte]	
PNIO submodule type	Data type	Input (I-PI)	Output (O-PI)	Input	Output
DC-Drive					
{UINT8, UINT8[5]} I/O	{Unsigned8, Unsigned8[5]}	6	6	8	8

14.1.6.6 RTC Module

The group of RTC modules has one module and one submodule type.

Table 95: Module types – RTC Module

Module type	Description	Substitute I/O modules
RTC	RTC Module	75x-640

For the RTC module, the provider and consumer status (IOPS, IOCS) of the input or output information are exchanged between the IO controller and IO device in both directions.

Table 96: Submodule types and data lengths – RTC Module

PNIO module type		Process data length [byte]/ allocation [bit]		Telegram allocation [byte]	
PNIO submodule type	Data type	Input (I-PI)	Output (O-PI)	Input	Output
RTC					
{UINT8, UINT8[5]} I/O	{Unsigned8, Unsigned8[5]}	6	6	8	8

14.1.6.7 DALI/DSI Master and DALI Multi-Master Modules

The group of DALI master modules has two module and submodule types.

Table 97: Module types – DALI/DSI Master and DALI Multi-Master Modules

Module type	Description	Substitute I/O modules
DALI/DSI	DALI/DSI Master Modules	75x-641
DALI	DALI Multi-Master Modules	75x-647

For the DALI/DSI master module and the DALI multi-master module, the provider and consumer status (IOPC, IOCS) are exchanged between the IO controller and IO device in both directions.

Table 98: Submodule types and data lengths – DALI/DSI Master and DALI Multi-Master Modules

PNIO module type		Process data length [byte]/ allocation [bit]		Telegram allocation [byte]	
PNIO submodule type	Data type	Input (I-PI)	Output (O-PI)	Input	Output
DALI/DSI					
{UINT8, UINT8[5]} I/O	{Unsigned8, Unsigned8[5]}	6	6	8	8
DALI					
{UINT8, UINT8[23]} I/O	{Unsigned8, Unsigned8[23]}	24	24	26	26

14.1.6.8 AS-Interface Master Modules

The group of AS-Interface Masters has one module type divided into six submodule types.

Table 99: Module types – AS-Interface Master Modules

Module type	Description	Substitute I/O modules
ASi-Master	AS-Interface-Master	75x-655

With the AS-Interface Master, the provider and consumer status (IOPS, IOCS) of the input or output information are exchanged between the IO controller and IO device in both directions.

Table 100: Submodule types and data lengths – AS-Interface Master Modules

PNIO module type		Process data length [byte]/ allocation [bit]		Telegram allocation [byte]	
PNIO submodule type	Data type	Input (I-PI)	Output (O-PI)	Input	Output
ASi-Master					
{UINT8, UINT8, UINT8[10]} I/O	{Unsigned8, Unsigned8, Unsigned8[10] }	6	6	8	8
{UINT8, UINT8, UINT8[18]} I/O	{Unsigned8, Unsigned8, Unsigned8[18] }	20	20	22	22
{UINT8, UINT8, UINT8[22]} I/O	{Unsigned8, Unsigned8, Unsigned8[22] }	24	24	26	26
{UINT8, UINT8, UINT8[30]} I/O	{Unsigned8, Unsigned8, Unsigned8[30] }	32	32	34	34
{UINT8, UINT8, UINT8[38]} I/O	{Unsigned8, Unsigned8, Unsigned8[38] }	40	40	42	42
{UINT8, UINT8, UINT8[46]} I/O	{Unsigned8, Unsigned8, Unsigned8[46] }	48	48	50	50

14.1.6.9 RF Modules

The group of radio receiver I/O modules has two module types divided into four submodule types.

Table 101: Module types – RF Modules

Module type	Description	Substitute I/O modules
RF-RCV EnOcean	RF-Receiver EnOcean	75x-642
Module type	Description	Substitute I/O modules
Bluetooth	Bluetooth® RF-Transceiver	75x-644

For the radio modules, the provider and consumer status (IOPS, IOCS) of the input or output information are exchanged between the IO controller and IO device in both directions.

Table 102: Submodule types and data lengths – RF Modules

PNIO module type		Process data length [byte]/ allocation [bit]		Telegram allocation [byte]	
PNIO submodule type	Data type	Input (I-PI)	Output (O-PI)	Input	Output
RF-RCV EnOcean					
{UINT8, UINT8[3]} I/O	{Unsigned8, Unsigned8[3]}	4	4	6	6
Bluetooth					
{UINT8[2], UINT8[10]} I/O	{Unsigned8 [2], Unsigned8[6]}	12	12	14	14
{UINT8[2], UINT8[22]} I/O	{Unsigned8[2], Unsigned8[22]}	24	24	26	26
{UINT8[2], UINT8[46]} I/O	{Unsigned8[2], Unsigned8[46]}	48	48	50	50

14.1.6.10 MP-Bus Master Modules

The MP-bus master module has one module and one submodule type.

Table 103: Module types – MP-Bus Master Modules

Module type	Description	Substitute I/O modules
MP-Bus-Master	MP-Bus Master Modules	75x-643

For the MP-bus master modules, the provider and consumer status (IOPS, IOCS) of the input or output information are exchanged between the IO controller and IO device in both directions.

Table 104: Submodule types and data lengths – MP-Bus Master Modules

PNIO module type		Process data length [byte]/ allocation [bit]		Telegram allocation [byte]	
PNIO submodule type	Data type	Input (I-PI)	Output (O-PI)	Input	Output
MP-Bus-Master					
{UINT8[2], UINT8[6]} I/O	{Unsigned8[2], Unsigned8[6]}	8	8	10	10

14.1.6.11 Vibration Monitoring

The group for vibration monitoring has one module and one submodule type.

Table 105: Module types – Vibration Monitoring

Module type	Description	Substitute I/O modules
VIB I/O	2-Channel Vibration Velocity / Bearing Condition Monitoring VIB I/O	75x-645

For the 2-channel vibration velocity/bearing condition monitoring VIB I/Os, the provider and consumer status (IOPS, IOCS) of the input or output information are exchanged between the IO controller and IO device in both directions.

Table 106: Submodule types and data lengths – Vibration Monitoring

PNIO module type		Process data length [byte]/ allocation [bit]		Telegram allocation [byte]	
PNIO submodule type	Data type	Input (I-PI)	Output (O-PI)	Input	Output
VIB I/O					
{UINT8, UINT16 UINT8, UINT8}[2] I/O	{Unsigned8, Unsigned16 Unsigned8, Unsigned8[2]}	12	12	14	14

14.1.6.12 Safety Modules PROFIsafe V2

The group of PROFIsafe V2 safety modules has one module and one submodule type.

Table 107: Module types – Safety Modules PROFIsafe V2

Module type	Description	Substitute I/O modules
PROFIsafe V2	Safety Modules PROFIsafe V2 iPar	75x-661/000-003, 75x-662/000-003, 750-663/000-003, 75x-666/000-003, 75x-667/000-003

For the PROFIsafe V2 safety modules, the provider and consumer status (IOPS, IOCS) of the input or output information are exchanged between the IO controller and IO device in both directions.

Table 108: Submodule types and data lengths – Safety Modules PROFIsafe V2 iPAR

PNIO module type		Process data length [byte]/ allocation [bit]		Telegram allocation [byte]	
PNIO submodule type	Data type	Input (I-PI)	Output (O-PI)	Input	Output
PROFIsafe V2					
{UINT8, UINT8[4]}I/O	{Unsigned8, Unsigned8[4]}	5	5	7	7

14.1.6.13 Stepper Modules

The group of stepper controllers has one module and one submodule type.

Table 109: Module types – Stepper Modules

Module type	Description	Substitute I/O modules
Stepper, Servo	Steppercontroller, Stepperservo	75x-670, 75x-671, 750-672, 750-673

For the stepper controllers, the provider and consumer status (IOPS, IOCS) of the input or output information are exchanged between the IO controller and IO device in both directions.

Table 110: Submodule types and data lengths – Stepper Modules

PNIO module type		Process data length [byte]/ allocation [bit]		Telegram allocation [byte]	
PNIO submodule type	Data type	Input (I-PI)	Output (O-PI)	Input	Output
Stepper, Servo					
{UINT8, UINT8, UINT8[10]}I/O	{Unsigned8[2], Unsigned8[7]} Unsigned8[3]}	12	12	14	14

14.1.6.14 I/O-Link Master (from FW 03)

Starting from FW 03, the I/O-Link Master modules 75x-675 are supported.

Information



Additional information about process data of I/O module!

For a detailed description of the process data of this module, please read in the manual for this I/O module under:

www.wago.com

14.1.6.15 CAN Gateway (from FW 03)

Starting from FW 03, the CAN Gateway modules 75x-678 are supported.

Information



Additional information about process data of I/O module!

For a detailed description of the process data of this module, please read in the manual for this I/O module under:

www.wago.com

14.1.6.16 Proportional Valve Module (from FW 03)

Starting from FW 03, the Prportional Valve Modules 75x-632 are supported.

Information



Additional information about process data of I/O module!

For a detailed description of the process data of this module, please read in the manual for this I/O module under:

www.wago.com

14.1.7 System Modules

14.1.7.1 Power Supply Modules

The group of power supply modules has one module type divided into four submodule types.

Table 111: Module types – Power Supply Modules

Module type	Description	Substitute I/O modules
Supply	Power Supply Modules with 2 bits diagnostics	750-606, 750-610, 750-611

Power supply modules supply a provider status (IOPS) to the IO controller. If the diagnostic data is available in the process image of the inputs, the power supply modules receive the consumer status (IOCS) from the IO controller as process qualifiers for the diagnostic data.

Table 112: Submodule types and data lengths– Power Supply Modules

PNIO module type		Process data length [byte]/ allocation [bit]				Telegram allocation [byte]	
PNIO submodule type	Data type	Input (I-PI)		Output (O-PI)		Input	Output
Supply							
DIA	-	0	0	0	0	1	1
2DIA in I-PI (+ 6 BIT I)	OctetString[1], bit field	1	2	0	0	1	1
2DIA in I-PI (+14 BIT I)	OctetString[2], bit field	2	2	0	0	2	1
2DIA in I-PI (+30 BIT I)	OctetString[4], bit field	4	2	0	0	3	1

14.2 Parameters of the I/O Modules

The following subchapters list the individual attribute values and descriptions for parameterization of the various I/O modules. The default attribute values are highlighted in "bold".

14.2.1 Digital Input Modules (DI)

All digital input modules that do not supply any diagnostic information do not receive a parameter data set from the IO controller.

However, digital input modules with diagnostics capability receive a parameter data set in the form of a record write request to the data set number or index 0x4000 or 16384.

This data set receives the following attributes channel-by-channel.

Table 113: Parameterization – Overview of Attributes for Digital Input Modules with Diagnostics (DI, DIA)

Attributes for Digital Input Modules with Diagnostics (DI, DIA)	
-	Channel diagnosis
-	Diagnosis: External fault

Table 114: Parameterization DI, DIA – Attributes "Channel diagnosis"

Attribute Name	Attribute Value	Description
Channel diagnosis	0 (false)	Any errors that may occur on the respective signal channel do not cause transmission of a diagnostic alarm nor entry in the diagnostics database of the station proxy.
	1 (true)	Any errors that may occur on the respective signal channel and the error type explicitly released entail transmission of a diagnostic alarm. The respective error leads to an entry in the diagnostics database of the station proxy.

Table 115: Parameterization DI, DIA – Attributes "Diagnosis: External fault"

Attribute Name	Attribute Value	Description
Diagnosis: External fault	0 (false)	An external error on the respective signal channel does not cause transmission of a diagnostic alarm nor entry in the diagnostics database of the station proxy.
	1 (true)	Provided that the channel diagnostics of the respective signal channel has been activated, an external error leads to transmission of a diagnostic alarm and entry in the diagnostics database of the station proxy.

14.2.2 Digital Output Modules (DO)

All digital output modules receive a parameter data set from the IO controller in the form of a record write request.

For standard modules, the parameter data set is sent to the data set number or index 0x4000 or 16384.

This data set receives the following attributes.

Table 116: Parameterization – Overview of Attributes for Digital Output Modules (DO)

Attributes for Digital Output Modules (DO)	
-	Substitute value behavior
-	Substitute value (1 Byte)

Table 117: Parameterization DO – Attributes "Substitute value behavior"

Attribute Name	Attribute Value	Description
Substitute value behavior	according to device settings	If an established AR is disconnected to which the submodule is assigned or when the status of the "Provider State Flag" changes in the APDU status of the consumer telegram from "RUN" to "STOP", the parameterized substitute value behavior of the station proxy is applied for the duration of missing output data. The parameterized substitute value of the respective output channel has no meaning in this context.
	keep last valid value	If an established AR is disconnected to which the submodule is assigned or when the status of the "Provider State Flag" changes in the APDU status of the consumer telegram from "RUN" to "STOP", the last valid status of the respective output channel is retained for the duration of the missing output data. The parameterized substitute value of the respective output channel has no meaning in this context.
	set substitute value	If an established AR is disconnected to which the submodule is assigned or when the status of the "Provider State Flag" changes in the APDU status of the consumer telegram from "RUN" to "STOP", the parameterized substitute value of the respective output channel is output for the duration of the missing output data.

Table 118: Parameterization DO – Attribute "Substitute value (1 Byte)"

Attribute Name	Attribute Value	Description
Substitute value (1 Byte)	0 (false)	In the state of missing output data, status '0' is output on the respective output channel with the set substitute value behavior "Output substitute value".
	1 (true)	In the state of missing output data, status '1' is output on the respective output channel with the set substitute value behavior "Output substitute value".

14.2.3 Digital Output Modules with Diagnostics (DO, DIA)

If the digital output module provides diagnostic data, the following attributes can also be set channel-by-channel during parameterization.

Table 119: Parameterization – Overview of Additional Attributes for Digital Output Modules with Diagnostics (DO, DIA)

Additional Attributes for Digital Output Modules with Diagnostics (DO, DIA)	
-	Channel diagnosis (additionally)
-	Diagnosis: External fault (additionally)
-	Diagnosis: Short circuit" (additionally)
-	Diagnosis: Line break (additionally)

Table 120: Parameterization DO, DIA – Attribute "Channel diagnosis"

Attribute Name	Attribute Value	Description
Channel diagnosis	0 (false)	Any errors that may occur on the respective signal channel do not cause transmission of a diagnostic alarm nor entry in the diagnostics database of the station proxy.
	1 (true)	Any errors that may occur on the respective signal channel and the error type explicitly released entail transmission of a diagnostic alarm. The respective error leads to an entry in the diagnostics database of the station proxy.

Table 121: Parameterization DO, DIA – Attribute "Diagnosis: External fault"

Attribute Name	Attribute Value	Description
Diagnosis: External fault	0 (false)	An external error on the respective signal channel does not cause transmission of a diagnostic alarm nor entry in the diagnostics database of the station proxy.
	1 (true)	Provided that the channel diagnostics of the respective signal channel has been activated, an external error leads to transmission of a diagnostic alarm and entry in the diagnostics database of the station proxy.

Table 122: Parameterization DO, DIA – Attribute "Diagnosis: Short circuit"

Attribute Name	Attribute Value	Description
Diagnosis: Short circuit	0 (false)	A short circuit on the respective signal channel does not lead to transmission of a diagnostic alarm nor to entry in the diagnostics database of the station proxy.
	1 (true)	Provided that the channel diagnostics of the respective signal channel has been activated, a short circuit leads to transmission of a diagnostic alarm and entry in the diagnostics database of the station proxy.

Table 123: Parameterization DO, DIA – Attribute "Diagnosis: Line break"

Attribute Name	Attribute Value	Description
Diagnosis: Line break	0 (false)	A line break on the respective signal channel does not lead to transmission of a diagnostic alarm nor to entry in the diagnostics database of the station proxy.
	1 (true)	Provided that the channel diagnostics of the respective signal channel has been activated, a line break leads to transmission of a diagnostic alarm and entry in the diagnostics database of the station proxy.

14.2.4 PROFIenergy Submodules (DO, PE)

When configuring PROFIenergy submodules, an additional parameter data set is sent to the data set number or index 0x5000 or 20480.

Regarding the PROFIenergy properties, the following attributes can also be specified during parameterization.

Table 124: Parameterization – Overview of Additional Attributes for PROFIenergy Submodules (DO, PE)

Additional Attributes for PROFIenergy Submodules (DO, PE)	
-	Minimal pause time (additionally)
-	Pause output state (additionally)

Table 125: Parameterization DO, PE – Attribute "Minimal pause time"

Attribute Name	Attribute Value	Description
Minimal pause time	10 s	Pauses requested by the PROFIenergy profile are only introduced during pause times greater than or equal to the setting made. If a PROFIenergy submodule has been configured from the station proxy, the setting made here for the respective output module has no meaning.
	1 min	
	10 min	
	1 h	
	10 h	
	1 d	
	infinite	

Table 126: Parameterization DO, PE – Attribute "Pause output state"

Attribute Name	Attribute Value	Description
Pause output state	0 (false)	If the requested pause time of the PROFIenergy "Start_Pause" command is greater than or equal to the parameterized "Minimum pause time", the respective output channel outputs status '0'.
	1 (true)	If the requested pause time of the PROFIenergy "Start_Pause" command is greater than or equal to the parameterized "Minimum pause time", the respective output channel outputs status '1'.

14.2.5 Analog Input Modules

All analog output modules receive a parameter data set in the form of a record write request to the data set number or index 0x4000 or 16384.

This data set receives the following attributes that can be set during parameterization depending on the I/O module type (item number).

Table 127: Parameterization – Overview of Attributes for Analog Input Modules (AI)

Attributes for Analog Input Modules (AI)	
-	Channel diagnosis
-	Diagnosis: External fault
-	Diagnosis: Measuring range overflow
-	Diagnosis: Measuring range underflow
-	Diagnosis: Short circuit
-	Diagnosis: Line break
-	Diagnosis: Lower user limit value exceeded
-	Diagnosis: Upper user limit value exceeded
-	Lower user limit value
-	Upper user limit value

Table 128: Parameterization AI – Attribute "Channel diagnosis"

Attribute Name	Attribute Value	Description
Channel diagnosis	0 (false)	An error on the respective signal channel does not lead to transmission of a diagnostic alarm nor entry in the diagnostics database of the station proxy.
	1 (true)	An error on the respective signal channel leads to transmission of a diagnostic alarm. The respective error leads to an entry in the diagnostics database of the station proxy.

Table 129: Parameterization AI – Attribute "Diagnosis: External fault"

Attribute Name	Attribute Value	Description
Diagnosis: External fault	0 (false)	An external error on the respective signal channel does not cause transmission of a diagnostic alarm nor entry in the diagnostics database of the station proxy.
	1 (true)	Provided that the channel diagnostics of the respective signal channel has been activated, an external error leads to transmission of a diagnostic alarm and entry in the diagnostics database of the station proxy.

Table 130: Parameterization AI – Attribute "Diagnosis: Measuring range overflow"

Attribute Name	Attribute Value	Description
Diagnosis: Measuring range overflow	0 (false)	An overrange on the respective signal channel does not lead to transmission of a diagnostic alarm nor entry in the diagnostics database of the station proxy.
	1 (true)	Provided that the channel diagnostics of the respective signal channel has been activated, an overrange leads to transmission of a diagnostic alarm and entry in the diagnostics database of the station proxy.

Table 131: Parameterization AI – Attribute "Diagnosis: Measuring range underflow"

Attribute Name	Attribute Value	Description
Diagnosis: Measuring range underflow	0 (false)	An overrange on the respective signal channel does not lead to transmission of a diagnostic alarm nor entry in the diagnostics database of the station proxy.
	1 (true)	Provided that the channel diagnostics of the respective signal channel has been activated, an undershoot leads to transmission of a diagnostic alarm and entry in the diagnostics database of the station proxy.

Table 132: Parameterization AI – Attribute "Diagnosis: Line break"

Attribute Name	Attribute Value	Description
Diagnosis: Line break	0 (false)	A line break on the respective signal channel does not lead to transmission of a diagnostic alarm nor to entry in the diagnostics database of the station proxy.
	1 (true)	Provided that the channel diagnostics of the respective signal channel has been activated, a line break leads to transmission of a diagnostic alarm and entry in the diagnostics database of the station proxy.

Table 133: Parameterization AI – Attribute "Diagnosis: Short circuit"

Attribute Name	Attribute Value	Description
Diagnosis: Short circuit	0 (false)	A short circuit on the respective signal channel does not lead to transmission of a diagnostic alarm nor to entry in the diagnostics database of the station proxy.
	1 (true)	Provided that the channel diagnostics of the respective signal channel has been activated, a short circuit leads to transmission of a diagnostic alarm and entry in the diagnostics database of the station proxy.

Table 134: Parameterization AI – Attribute "Diagnosis: Lower limit value exceeded"

Attribute Name	Attribute Value	Description
Diagnosis: Lower user limit value exceeded	0 (false)	Falling below the lower user limit on the respective signal channel does not lead to transmission of a process alarm. The lower user limit is set in another attribute.
	1 (true)	Provided that the channel diagnostics of the respective signal channel has been activated, falling below the lower user limit leads to transmission of a process alarm. No entry in the diagnostics database of the station proxy is not made. The lower user limit is set in another attribute.

Table 135: Parameterization AI – Attribute "Diagnosis: Upper limit value exceeded"

Attribute Name	Attribute Value	Description
Diagnosis: Upper user limit value exceeded	0 (false)	Exceeding the upper use limit on the respective signal channel does not lead to transmission of a process alarm. The upper user limit is set in another attribute.
	1 (true)	Provided that the channel diagnostics of the respective signal channel has been activated, exceeding the upper user limit leads to transmission of a process alarm. No entry in the diagnostics database of the station proxy is not made. The upper user limit is set in another attribute.

Table 136: Parameterization AI – Attribute "Lower user limit"

Attribute Name	Attribute Value	Description
Lower user limit value	0 ... 32767 -32767 ... 32767 0 ... 65535	Based on the value range of the input signal, a lower limit value of the input signal can be specified that can lead to the abovementioned event of a process alarm.

Table 137: Parameterization AI – Attribute "Upper user limit"

Attribute Name	Attribute Value	Description
Upper user limit value	0 ... 32767 -32767 ... 32767 0 ... 65535	Based on the value range of the input signal, an upper limit value of the input signal can be specified that can lead to the abovementioned event of a process alarm.

14.2.6 Special AI Module Types (AI, RTD, TC)

In addition the the attributes described above, there are other attributes for the standard modules with no item number extension and for the variants with item number extension "/003-000" depending on the I/O module type.

Table 138: Parameterization – Overview of Additional Attributes for Special AI Module Types (2/4 AI, RTD, TC)

Additional Attributes for Special AI Module Types (2/4 AI, RTD, TC)	
-	User scaling (depends on module type)
-	User offset (depends on module type)
-	User gain (depends on module type)
-	Vendor scaling (depends on module type)
-	Watchdog timer (depends on module type)
-	Vendor scaling (depends on module type)
-	Status flags (depends on module type)
-	Filter (depends on module type)
-	Filter constant (depends on module type)
-	Sensor type (depends on module type)
-	Overrange protection (depends on module type)
-	Connection type (depends on module type)
-	Wire break detection (depends on module type)
-	Check lower measurement range limit (depends on module type)
-	Cold junction compensation (depends on module type)

Table 139: Parameterization 2AI, RTD, TC – Attribute "User scaling"

Attribute Name	Attribute Value	Description
User scaling	disabled	See manual for I/O module 75x-461, 75x-481, 75x-469 www.wago.com
	enabled	

Table 140: Parameterization 2AI, RTD, TC – Attribute "User offset"

Attribute Name	Attribute Value	Description
User offset	-32767 ... 0 ...32767	See manual for I/O module 75x-461, 75x-481, 75x-469 www.wago.com

Table 141: Parameterization 2AI, RTD, TC – Attribute "User gain"

Attribute Name	Attribute Value	Description
User gain	-32767 ... 256 ...32767	See manual for I/O module 75x-461, 75x-481, 75x-469 www.wago.com

Table 142: Parameterization 2AI, RTD, TC – Attribute "Vendor scaling"

Attribute Name	Attribute Value	Description
Vendor scaling	disabled	See manual for I/O module 75x-461, 75x-481, 75x-469 www.wago.com
	enabled	

Table 143: Parameterization 2AI, RTD, TC – Attribute "Watchdog timer"

Attribute Name	Attribute Value	Description
Watchdog timer	disabled	See manual for I/O module 75x-461, 75x-481, 75x-469 www.wago.com
	enabled	

Table 144: Parameterization 2AI, RTD, TC – Attribute "Vendor scaling"

Attribute Name	Attribute Value	Description
Vendor scaling	Twos complement	See manual for I/O module 75x-461, 75x-481, 75x-469 www.wago.com
	Signed amount	

Table 145: Parameterization 2AI, RTD, TC – Attribute "Status flags"

Attribute Name	Attribute Value	Description
Status flags	disabled	See manual for I/O module 75x-461, 75x-481, 75x-469 www.wago.com
	enabled	

Table 146: Parameterization 2AI, RTD, TC – Attribute "Filter"

Attribute Name	Attribute Value	Description
Filter	disabled	See manual for I/O module 75x-461, 75x-481, 75x-469 www.wago.com
	enabled	

Table 147: Parameterization AI, RTD 461– Attribute "Filter constant"

Attribute Name	Attribute Value	Description
Filter constant	400 Hz, 15 ms	See manual for I/O module 75x-461 www.wago.com
	200 Hz, 32 ms	
	100 Hz, 65 ms	
	60 Hz, 110 ms	
	50 Hz, 125 ms	
	25 Hz, 250 ms	
	12,5 Hz, 500 ms	

Table 148: Parameterization AI, RTD 481– Attribute "Filter constant"

Attribute Name	Attribute Value	Description
Filter constant	1000 Hz, 16 ms	See manual for I/O module 75x-481 www.wago.com
	400 Hz, 40 ms	
	200 Hz, 80 ms	
	100 Hz, 160 ms	
	60 Hz, 270 ms	
	50 Hz, 320 ms	
	25 Hz, 640 ms	

Table 149: Parameterization AI, TC – Attribute "Filter constant"

Attribute Name	Attribute Value	Description
Filter constant"	200 Hz, 80 ms	See manual for I/O module 75x-469 www.wago.com
	100 Hz, 160 ms	
	50 Hz, 320 ms	
	25 Hz, 640 ms	

Table 150: Parameterization 2AI, RTD 461, 481 – Attribute "Sensor type"

Attribute Name	Attribute Value	Description
Sensor type	Thermal resistor PT 100	See manual for I/O module 75x-461, 75x-481 www.wago.com
	Thermal resistor NI 100	
	Thermal resistor PT 1000	
	Thermal resistor PT 500	
	Thermal resistor PT 200	
	Thermal resistor NI 1000	
	Thermal resistor NI 120	
	Potentiometer 1k	
	Potentiometer 5k	
	Resistor 5k	
	Resistor 1k	

Table 151: Parameterization 2AI, RTD – Attribute "Overrange protection"

Attribute Name	Attribute Value	Description
Overrange protection	disabled	See manual for I/O module 75x-461, 75x-481 www.wago.com
	enabled	

Table 152: Parameterization 2AI, RTD 463 – Attribute "Sensor type"

Attribute Name	Attribute Value	Description
Sensor type	PT 1000 (IEC 751)	See manual for I/O module 75x-463 www.wago.com
	NI 1000 (DIN 43760)	
	NI 1000 (TK 5000)	
	KTY 81 110	
	KTY 81 210	

Table 153: Parameterization 4AI, RTD 464 – Attribute "Sensor type"

Attribute Name	Attribute Value	Description
Sensor type	PT 100 (IEC 751)	See manual for I/O module 75x-464 www.wago.com
	NI 100 (DIN 43760)	
	PT 1000 (IEC 751)	
	PT 500 (IEC 751)	
	PT 200 (IEC 751)	
	NI 1000 (DIN 43760)	
	NI 120 (Minco)	
	NI 1000 (TK 5000)	
	Potentiometer	
	Resistor 10R ... 5k (linear)	
	Resistor 10R ... 1.2k (linear)	

Table 154: Parameterization 4AI, RTD 464/020-000 – Attribute "Sensor type"

Attribute Name	Attribute Value	Description
Sensor type	NTC 10k	See manual for I/O module 75x-464 www.wago.com
	NTC 20k	
	NTC-Thermokon 10k	

Table 155: Parameterization 2AI, RTD 464 – Attribute "Connection type"

Attribute Name	Attribute Value	Description
Connection type	2-wire connection	See manual for I/O module 75x-464 www.wago.com
	3-wire connection	

Table 156: Parameterization AI, PM 494 – Attribute "DC measurement"

Attribute Name	Attribute Value	Description
DC measurement	disabled	See manual for I/O module 75x-494 www.wago.com
	enabled	

Table 157: Parameterization 2AI, RTD 461, 481 – Attribute "Connection type"

Attribute Name	Attribute Value	Description
Connection type	2-wire connection	See manual for I/O module 75x-461, 75x-481 www.wago.com
	3-wire connection	

Table 158: Parameterization 2AI, TC – Attribute "Sensor type"

Attribute Name	Attribute Value	Description
Sensor type	Thermocouple type L	By selection of the used sensor type, the corresponding curve for the TC signal channel for the AI, TC is set.
	Thermocouple type K	
	Thermocouple type J	
	Thermocouple type E	
	Thermocouple type T	
	Thermocouple type N	
	Thermocouple type U	
	Thermocouple type B	
	Thermocouple type R	
	Thermocouple type S	
	Voltage +/-30 mV	
	Voltage +/-60 mV	
	Voltage +/-120 mV	

The 2-channel / 4-channel analog input modules for resistance sensors 750-464, the 4-channel analog input modules for resistance sensors 750-463 and the 3-phase power measurement modules 750-494 and 750-495 still receive a parameter set in the form of a record write request to the data set number or index 0x2000 or 8192.

This data set receives the following attributes that can be set during parameterization depending on the I/O module type (item number).

Table 159: Parameterization AI, TC – Attribute "Wire break detection"

Attribute Name	Attribute Value	Description
Wire break detection	enabled	If a line break on the respective signal input is detected, a corresponding diagnostic alarm is transmitted and an entry made in the diagnostics database of the station proxy.
	disabled	If a line break on the respective signal input is detected, no corresponding diagnostic alarm is transmitted and no entry is made in the diagnostics database of the station proxy.

Table 160: Parameterization AI, TC – Attribute "Check lower measurement range limit"

Attribute Name	Attribute Value	Description
Check lower measurement range limit	enabled	If the lower limit of the respective measuring range is reached, a corresponding diagnostic alarm is transmitted and an entry is made in the diagnostics database of the station proxy.
	disabled	If the lower limit of the respective measuring range is reached, no corresponding diagnostic alarm is transmitted and no entry is made in the diagnostics database of the station proxy.

Table 161: Parameterization AI, TC – Attribute "Cold junction compensation"

Attribute Name	Attribute Value	Description
Cold junction compensation	enabled	The cold junction compensation of the respective signal channel is activated.
	disabled	The cold junction compensation of the respective signal channel is deactivated.

Table 162: Parameterization AI, 3 PM – Attribute "Watchdog"

Attribute Name	Attribute Value	Description
Watchdog	disabled	See manual for I/O module 75x-494, 75x-495 www.wago.com
	enabled	

Table 163: Parameterization AI, 3 PM – Attribute "Nom. frequency power supply"

Attribute Name	Attribute Value	Description
Nom. frequency power supply	50 Hz	See manual for I/O module 75x-494, 75x-495 www.wago.com
	60 Hz	

Table 164: Parameterization AI, 3 PM 495 – Attribute "Identifier Rogowski coils"

Attribute Name	Attribute Value	Description
Identifier Rogowski coils	RT500	See manual for I/O module 75x-495 www.wago.com
	RT2000	

Table 165: Parameterization AI, 3 PM – Attribute "Peak value phase"

Attribute Name	Attribute Value	Description
Peak value phase	L1	See manual for I/O module 75x-494, 75x-495 www.wago.com
	L2	
	L3	

Table 166: Parameterization AI, 3 PM – Attribute "Autoreset min./max. value"

Attribute Name	Attribute Value	Description
Autoreset min./max. value	disabled	See manual for I/O module 75x-494, 75x-495 unter: www.wago.com
	enabled	

Table 167: Parameterization AI, 3 PM – Attribute "User scaling"

Attribute Name	Attribute Value	Description
User scaling	disabled	See manual for I/O module 75x-494, 75x-495 www.wago.com
	enabled	

Table 168: Parameterization AI, 3 PM – Attribute "Scaling energy consumption"

Attribute Name	Attribute Value	Description
Scaling energy consumption	1 mWh	See manual for I/O module 75x-494, 75x-495 www.wago.com
	0.01 Wh	
	0.1 Wh	
	1 Wh	
	0.01 kWh	
	0.1 kWh	
	1 kWh	

Table 169: Parameterization AI, 3 PM – Attribute "Scaling energy consumption"

Attribute Name	Attribute Value	Description
Scaling energy consumption	5 mWh	See manual for I/O module 75x-494, 75x-495 unter: www.wago.com
	0.05 Wh	
	0.5 Wh	
	5 Wh	
	0.05 kWh	
	0.5 kWh	
	5 kWh	

Table 170: Parameterization AI, 3 PM – Attribute "Storage interval energy [s]"

Attribute Name	Attribute Value	Description
Storage interval energy [s]	60 ... 255	See manual for I/O module Busklemme 75x-494, 75x-495 www.wago.com

Table 171: Parameterization AI, 3 PM – Attribute "Current transformer ratio"

Attribute Name	Attribute Value	Description
Current transformer ratio, LB	0, 1 ... 255	See manual for I/O module 75x-494, 75x-495 www.wago.com
Current transformer ratio, HB	0 ... 255	

Table 172: Parameterization AI, 3 PM – Attribute "Peak value meas. interval [HW]"

Attribute Name	Attribute Value	Description
Peak value meas. interval [HW]	6 ... 10 ... 254	See manual for I/O module 75x-494, 75x-495 www.wago.com

Table 173: Parameterization AI, 3 PM – Attribute "Min./Max. reset interval [200ms]"

Attribute Name	Attribute Value	Description
Min./Max. reset interval [200ms]	0 ... 10 ... 254	See manual for I/O module 75x-494, 75x-495 www.wago.com

14.2.7 Analog Output Module (AO)

All analog output modules receive a parameter data set from the IO controller in the form of a record write request.

For standard modules, the parameter data set is intended for the data set number or index 0x4000 or 16384.

This data set receives the following attributes.

Table 174: Parameterization – Overview of Attributes for Analog Output Modules (AO)

Attributes for Analog Output Modules (AO)	
-	Substitute value behavior
-	Substitute value (2 Byte)

Table 175: Parameterization AO – Attribute "Substitute value behavior"

Attribute Name	Attribute Value	Description
Substitute value behavior	according to device settings	If an established AR is disconnected to which the submodule is assigned or when the status of the "Provider State Flag" changes in the APDU status of the consumer telegram from "RUN" to "STOP", the parameterized substitute value behavior of the station proxy is applied for the duration of missing output data. The parameterized substitute value of the respective output channel has no meaning in this context.
	keep last valid value	If an established AR is disconnected to which the submodule is assigned or when the status of the "Provider State Flag" changes in the APDU status of the consumer telegram from "RUN" to "STOP", the last valid status of the respective output channel is retained for the duration of the missing output data. The parameterized substitute value of the respective output channel has no meaning in this context.
	set substitute value	If an established AR is disconnected to which the submodule is assigned or when the status of the "Provider State Flag" changes in the APDU status of the consumer telegram from "RUN" to "STOP", the parameterized substitute value of the respective output channel is output for the duration of the missing output data.

Table 176: Parameterization AO – Attribute "Substitute value (2 Byte)"

Attribute Name	Attribute Value	Description
Substitute value (2 Byte)	-32767 ... 0 ... 32767	In the state of missing output data, the set substitute value is output on the respective output channel with the set substitute value behavior "Output substitute value".

14.2.8 Analog Output Module with Diagnostics (AO, DIA)

If the analog output module provides diagnostic data, the following attributes can also be set channel-by-channel during parameterization.

Table 177: Parameterization – Overview of additional Attributes for Analog Output Modules with Diagnostics (AO, DIA)

Additional Attributes for Analog Output Modules with Diagnostics (AO, DIA)	
-	Channel diagnosis (additionally)
-	Diagnosis: Short circuit (additionally)
-	Diagnosis: Undervoltage (additionally)
-	Diagnosis: Overtemperature (additionally)
-	Diagnosis: Error (additionally)
-	Diagnosis: External fault (additionally)

Table 178: Parameterization AO, DIA – Attribute "Channel diagnosis"

Attribute Name	Attribute Value	Description
Channel diagnosis	0 (false)	If the analog output module provides diagnostic data, the following attributes can also be set channel-by-channel during parameterization.
	1 (true)	If the analog output module provides diagnostic data, the following attributes can also be set channel-by-channel during parameterization.

Table 179: Parameterization AO, DIA – Attribute "Diagnosis: Short circuit"

Attribute Name	Attribute Value	Description
Diagnosis: Short circuit	0 (false)	A short circuit on the respective signal channel does not lead to transmission of a diagnostic alarm nor to entry in the diagnostics database of the station proxy.
	1 (true)	A short circuit on the respective signal channel leads to transmission of a diagnostic alarm. The respective error leads to an entry in the diagnostics database of the station proxy.

Table 180: Parameterization AO, DIA – Attribute "Diagnosis: Undervoltage"

Attribute Name	Attribute Value	Description
Diagnosis: Undervoltage	0 (false)	A low voltage on the respective signal channel does not lead to transmission of a diagnostic alarm nor entry in the diagnostics database of the station proxy.
	1 (true)	A low voltage on the respective signal channel leads to transmission of a diagnostic alarm. The respective error leads to an entry in the diagnostics database of the station proxy.

Table 181: Parameterization AO, DIA – Attribute "Diagnosis: Overtemperature"

Attribute Name	Attribute Value	Description
Diagnosis: Overtemperature	0 (false)	An overtemperature in the output driver of the respective signal channel does not lead to transmission of a diagnostic alarm nor entry in the diagnostics database of the station proxy.
	1 (true)	An overtemperature in the output driver of the respective signal channel leads to transmission of a diagnostic alarm. The respective error leads to an entry in the diagnostics database of the station proxy.

Table 182: Parameterization AO, DIA – Attribute "Diagnosis: Error"

Attribute Name	Attribute Value	Description
Diagnosis: Error	0 (false)	An external or internal error on the respective signal channel does not cause transmission of a diagnostic alarm nor entry in the diagnostics database of the station proxy.
	1 (true)	An error on the respective signal channel leads to transmission of a diagnostic alarm. The respective error leads to an entry in the diagnostics database of the station proxy.

Table 183: Parameterization AO, DIA – Attribute "Diagnosis: External fault"

Attribute Name	Attribute Value	Description
Diagnosis: External fault	0 (false)	An external fault on the respective signal channel does not cause transmission of a diagnostic alarm nor entry in the diagnostics database of the station proxy.
	1 (true)	An external fault on the respective signal channel leads to transmission of a diagnostic alarm. The respective error leads to an entry in the diagnostics database of the station proxy.

14.2.9 Special AO Module Types with Parameter Channel (AO, 562, 563)

For standard modules equipped with a parameter channel, another parameter data set is sent to the data set number or index 0x2000 or 8192.

Depending on the I/O module type (item number), the following additional attributes can then be set during parameterization.

Table 184: Parameterization – Overview of Additional Attributes for Special AO Module Types with Parameter Channel(AO, 562, 563)

Additional Attributes for Special AO Module Types with Parameter Channel (AO, 562, 563)	
-	User scaling (depends on module type)
-	Calibration (depends on module type)
-	Number representation (depends on module type)
-	Operating mode (depends on module type)
-	On exceeding user limits (depends on module type)
-	Output (depends on module type)
-	Behavior on K-Bus timeout (depends on module type)
-	Switch-on delay [s] (depends on module type)

Table 185: Parameterization AO, 562, 563 – Attribute "User scaling"

Attribute Name	Attribute Value	Description
User scaling	enabled	The entries in the "User Offset" and "User Gain" attributes are used to calculate the value range.
	disabled	The entries in the "User Offset" and "User Gain" attributes are not used to calculate the value range.

Table 186: Parameterization AO, 562, 563 – Attribute "Calibration"

Attribute Name	Attribute Value	Description
Calibration	User	See corresponding manual for I/O modules
	Factory	75x-562, 750-563 www.wago.com

Table 187: Parameterization AO, 562, 563 – Attribute "Number representation"

Attribute Name	Attribute Value	Description
Number representation	Twos complement	See corresponding manual for I/O modules 75x-562, 750-563
	Value plus sign	www.wago.com.

Table 188: Parameterization AO, 562, 563 – Attribute "Operating mode"

Attribute Name	Attribute Value	Description
Operating mode	0-10 V	See manual for I/O module 75x-562 www.wago.com.
	+/-10 V	
	0-20 mA	See manual for I/O module 750-563 www.wago.com.
	4-20 mA	
	6-18 V	

Table 189: Parameterization AO, 562, 563 – Attribute "On exceeding user limits"

Attribute Name	Attribute Value	Description
On exceeding user limits	No limitation of output value	See corresponding manual for I/O modules 75x-562,
	Limitation of output value	750-563 www.wago.com.

Table 190: Parameterization AO, 562, 563 – Attribute "Output"

Attribute Name	Attribute Value	Description
Output	in parameterized operating mode	See corresponding manual for I/O modules 75x-562, 750-563 www.wago.com.
	high-impedance	

Table 191: Parameterization AO, 562, 563 – Attribute "Behavior on K-Bus timeout"

Attribute Name	Attribute Value	Description
Behavior on K-Bus timeout	output 0 V	See corresponding manual for I/O modules 75x-562, 750-563 www.wago.com.
	hold last output value	
	output factory substitute value	
	output user substitute value	

Table 192: Parameterization AO, 562, 563 – Attribute "Switch-on delay [s]"

Attribute Name	Attribute Value	Description
Switch-on delay [s]	0	See corresponding manual for I/O modules 75x-562, 750-563 www.wago.com.
	0.10	
	0.20	
	0.30	
	0.50	
	0.75	
	1.00	
	2.00	

14.2.10 PROFIenergy Submodules (AO, PE)

When configuring PROFIenergy submodules, an additional parameter data set is sent to the data set number or index 0x5000 or 20480.

Regarding the PROFIenergy properties, the following attributes can also be specified during parameterization.

Table 193: Parameterization – Overview of Additional Attributes for PROFIenergy Submodules (AO, PE)

Additional Attributes for PROFIenergy Submodules (AO, PE)	
-	Minimal pause time (additionally)
-	Pause output value (additionally)

Table 194: Parameterization AO, PE – Attribute "Minimal pause time"

Attribute Name	Attribute Value	Description
Minimal pause time	10 s	Pauses requested by the PROFIenergy profile are only introduced during pause times greater than or equal to the setting made. If a PROFIenergy submodule has been configured from the station proxy, the setting made here for the respective output module has no meaning.
	1 min	
	10 min	
	1 h	
	10 h	
	1 d	
	infinite	

Table 195: Parameterization DO, PE – Attribute "Pause output value"

Attribute Name	Attribute Value	Description
Pause output value	0 ... 32767 -32767 ... 0 ... 32767 0 ... 65535	If the requested pause time of the PROFIenergy "Start_Pause" command is greater than or equal to the parameterized "Minimum pause time", the respective output channel outputs the specified pause output value.

14.2.11 Specialty Modules

Nearly all special-purpose modules receive a parameter data set in the form of a record write request to the data set number or index 0x4000 or 16384.

This data set receives the following attributes.

Table 196: Parameterization SF, DIA – Attribute "Channel diagnosis"

Attribute Name	Attribute Value	Description
Channel diagnosis	0 (false)	An error on the respective signal channel does not lead to transmission of a diagnostic alarm nor entry in the diagnostics database of the station proxy.
	1 (true)	An error on the respective signal channel leads to transmission of a diagnostic alarm. The respective error leads to an entry in the diagnostics database of the station proxy.

Table 197: Parameterization SF, DIA – Attribute "Diagnosis: External fault"

Attribute Name	Attribute Value	Description
Diagnosis: External fault	0 (false)	An external fault on the respective signal channel does not cause transmission of a diagnostic alarm nor entry in the diagnostics database of the station proxy.
	1 (true)	Provided that the channel diagnostics of the respective signal channel has been activated, an external fault leads to transmission of a diagnostic alarm and entry in the diagnostics database of the station proxy.

Table 198: Parameterization SF, DIA – Attribute "Diagnosis: Error"

Attribute Name	Attribute Value	Description
Diagnosis: Error	0 (false)	An internal or external error on the respective signal channel does not cause transmission of a diagnostic alarm nor entry in the diagnostics database of the station proxy.
	1 (true)	Provided that the channel diagnostics of the respective signal channel has been activated, an internal or external error leads to transmission of a diagnostic alarm and entry in the diagnostics database of the station proxy.

Table 199: Parameterization SF, DIA – Attribute "Diagnosis: Undervoltage"

Attribute Name	Attribute Value	Description
Diagnosis: Undervoltage	0 (false)	A low voltage on the respective signal channel does not lead to transmission of a diagnostic alarm nor entry in the diagnostics database of the station proxy.
	1 (true)	A low voltage on the respective signal channel leads to transmission of a diagnostic alarm and entry in the diagnostics database of the station proxy.

Table 200: Parameterization SF, SSI 630 – Attribute "Diagnosis: Sampling error"

Attribute Name	Attribute Value	Description
Diagnosis: Sampling error	0 (false)	A sampling error does not lead to transmission of a diagnostic alarm nor entry in the diagnostics database of the station proxy.
	1 (true)	Provided that the channel diagnostics has been activated, a sampling error leads to transmission of a diagnostic alarm and entry in the diagnostics database of the station proxy.

Table 201: Parameterization SF, ENC – Attribute "Diagnosis: Upper limit value exceeded"

Attribute Name	Attribute Value	Description
Diagnosis: Upper limit value exceeded	0 (false)	An overflow of the receiver buffer does not lead to transmission of a diagnostic alarm nor entry in the diagnostics database of the station proxy.
	1 (true)	Provided that the channel diagnostics has been activated, an overflow of the receive butter leads to transmission of a diagnostic alarm and entry in the diagnostics database of the station proxy.

Table 202: Parameterization SF, ENC – Attribute "Sensor or load voltage missing"

Attribute Name	Attribute Value	Description
Sensor or load voltage missing	0 (false)	Absence of the power supply does not lead to transmission of a diagnostic alarm nor entry in the diagnostics database of the station proxy.
	1 (true)	Provided that the module diagnostics has been activated, absence of the power supply leads to transmission of a diagnostic alarm and entry in the diagnostics database of the station proxy.

Table 203: Parameterization SF, ASi – Attribute "Diagnosis: Bus fault"

Attribute Name	Attribute Value	Description
Diagnosis: Bus fault	0 (false)	A bus fault does not lead to transmission of a diagnostic alarm nor entry in the diagnostics database of the station proxy.
	1 (true)	Provided that the channel diagnostics has been activated, a bus fault leads to transmission of a diagnostic alarm and entry in the diagnostics database of the station proxy.

Table 204: Parameterization SF, SSI 630 – Attribute "Baud rate [kHz]"

Attribute Name	Attribute Value	Description
Baud rate [kHz]	1000.0	See manual for I/O module 75x-630 www.wago.com
	250.0	
	125.0	
	100.0	
	83.0	
	71.0	
	62.5	

Table 205: Parameterization SF, SSI 630 – Attribute "SSI frame"

Attribute Name	Attribute Value	Description
SSI frame	32 Bit	See manual for I/O module 75x-630 www.wago.com
	acc. to SSI clocks (125 kHz only)	

Table 206: Parameterization SF, SSI 630 – Attribute "SSI clocks"

Attribute Name	Attribute Value	Description
SSI clocks	1 ... 32	See manual for I/O module 75x-630 www.wago.com

Table 207: Parameterization SF, SSI 630 – Attribute "Relevant data length [bit]"

Attribute Name	Attribute Value	Description
Relevant data length [bit]	0 ... 24 ... 32	See manual for I/O module 75x-630 www.wago.com

Table 208: Parameterization SF, SSI 630 – Attribute Synchronous operation

Attribute Name	Attribute Value	Description
Synchronous operation	0 (false)	See manual for I/O module 75x-630 www.wago.com
	1 (true)	

Table 209: Parameterization SF, SSI 630 – Attribute "Gray-Dual code conversion"

Attribute Name	Attribute Value	Description
Gray-Dual code conversion	0 (false)	See manual for I/O module 75x-630 www.wago.com
	1 (true)	

Table 210: Parameterization SF, SSI 630 – Attribute "Single-turn evaluation"

Attribute Name	Attribute Value	Description
Single-turn evaluation	0 (false)	See manual for I/O module 75x-630 www.wago.com
	1 (true)	

Table 211: Parameterization SF, SSI 630 – Attribute "Disable frame error detection"

Attribute Name	Attribute Value	Description
Disable frame error detection	0 (false)	See manual for I/O module 75x-630 www.wago.com
	1 (true)	

Table 212: Parameterization SF, SER – Attribute "Transmission rate area [baud]"

Attribute Name	Attribute Value	Description
Transmission rate area [baud]	1200 to 19200	See manual for I/O module 75x-650, 75x-653 www.wago.com
	38400 or 57600	

Table 213: Parameterization SF, SER – Attribute "Transmission rate [baud]"

Attribute Name	Attribute Value	Description
Transmission rate [baud]	1200	See manual for I/O module 75x-650, 75x-653 www.wago.com
	2400	
	4800	
	9600/38400	
	19200	
	57600	

Table 214: Parameterization SF, SER – Attribute "Data frame"

Attribute Name	Attribute Value	Description
Data frame	7E1	See manual for I/O module 75x-650, 75x-653 www.wago.com
	7O1	
	8N1	
	8E1	
	8O1	
	7E2	
	7O2	
	8N2	
	8E2	
	8O2	

The RS-232/RS-485 75x652 serial interface receives an additional parameter data set from the IO controller in the form of a record write request to the data set number or index 0x2000 or 8192.

The PROFINET IO parameters of this I/O module are documented in the 75x-652 I/O module manual at www.wago.com.

The *Bluetooth*[®] RF Transceiver (750-644) and AS-Interface Master (75x-655) receives an additional parameter data set from the IO controller in the form of a record write request to the data set number or index 0x2000 or 8192.

This data set receives the following attributes.

Table 215: Parameterization SF, ASi 655, BT 644 – Attribute "Mailbox length"

Attribute Name	Attribute Value	Description
Mailbox length	No mailbox	See manual for I/O module 75x-655 www.wago.com
	6 Byte	See manual for I/O module 750-644, 75x-655 www.wago.com
	10 Byte	See manual for I/O module 75x-655 www.wago.com
	12 Byte	See manual for I/O module 750-644, 75x-655 www.wago.com
	18 Byte	www.wago.com

Table 216: Parameterization SF, ASi 655, BT 644 – Attribute "Cross-fading of mailbox"

Attribute Name	Attribute Value	Description
Cross-fading of mailbox	disabled	See manual for I/O module 750-644, 75x-655 www.wago.com
	enabled	

Table 217: Parameterization SF, ASi 655 – Attribute "Use of free PI areas"

Attribute Name	Attribute Value	Description
Use of free PI areas	none (with ASi V2.1)	See manual for I/O module 75x-655 www.wago.com
	Analog values (starting ASi 3.0)	

14.2.12 System Modules

All system modules with diagnostics capability receive a parameter set in the form of a record write request to the data set number or index 0x4000 or 16384.

Depending on the I/O module type (item number), the following attributes can be set during parameterization.

Table 218: Parameterization – Overview of Attributes for System Modules with Diagnostics (PS, DIA)

Attributes for System Modules with Diagnostics (PS, DIA)	
-	Module diagnosis
-	Sensor or load voltage missing
-	Diagnosis: Fuse blown/open
-	Diagnosis: Undervoltage
-	Diagnosis: External fault

Table 219: Parameterization PS, DIA – Attribute "Module diagnosis"

Attribute Name	Attribute Value	Description
Module diagnosis	0 (false)	An error does not lead to transmission of a diagnostic alarm nor entry in the diagnostics database of the station proxy.
	1 (true)	The respective error leads to an entry in the diagnostics database of the station proxy if module diagnostics is enabled. An error leads to transmission of a diagnostic alarm. The respective error leads to an entry in the diagnostics database of the station proxy.

Table 220: Parameterization PS, DIA – Attribute "Sensor or load voltage missing"

Attribute Name	Attribute Value	Description
Sensor or load voltage missing	0 (false)	Absence of the power supply does not lead to transmission of a diagnostic alarm nor entry in the diagnostics database of the station proxy.
	1 (true)	Absence of the power supply leads to transmission of a diagnostic alarm. The respective error leads to an entry in the diagnostics database of the station proxy if module diagnostics is enabled.

Table 221: Parameterization PS, 750-610, 750-611 – Attribute "Diagnosis: Fuse blown/open"

Attribute Name	Attribute Value	Description
Diagnosis: Fuse blown/open	0 (false)	A defective fuse does not lead to transmission of a diagnostic alarm nor entry in the diagnostics database of the station proxy.
	1 (true)	A defective fuse leads to transmission of a diagnostic alarm. The respective error leads to an entry in the diagnostics database of the station proxy if module diagnostics is enabled.

Table 222: Parameterization PS, 750-606 – Attribute "Diagnosis: Undervoltage"

Attribute Name	Attribute Value	Description
Diagnosis: Undervoltage	0 (false)	An undervoltage does not lead to transmission of a diagnostic alarm nor entry in the diagnostics database of the station proxy.
	1 (true)	An undervoltage leads to transmission of a diagnostic alarm. The respective error leads to an entry in the diagnostics database of the station proxy if module diagnostics is enabled. An undervoltage leads to transmission of a diagnostic alarm. The respective error leads to an entry in the diagnostics database if module diagnostics is enabled.

Table 223: Parameterization PS, 750-606 – Attribute "Diagnosis: External fault"

Attribute Name	Attribute Value	Description
Diagnosis: External fault	0 (false)	An external fault does not lead to transmission of a diagnostic alarm nor entry in the diagnostics database of the station proxy.
	1 (true)	An external fault leads to transmission of a diagnostic alarm. The respective error leads to an entry in the diagnostics database of the station proxy if module diagnostics is enabled.

14.3 Record Data Sets

For acyclic access, the fieldbus coupler has so-called record data sets listed in the following table.

The table contains the index, description, access rights and addressing level of the respective data set.

For indices 0x0000 - 0x7FFF, the PROFINET IO specification involves manufacturer indices only used for manufacturer-specific parameterization of the IO device.

Information



More information on record data sets!

You can read more about special record data sets in the context of diagnostics.

The structure of standardized diagnostic data sets and channel-specific diagnostics are explained in the chapter "Channel-Specific Diagnostics".

Table 224: Record data sets

Index [hex]	Data set	Access	Level
2000	Parameter data, administrated by I/O module	r/w	Submodule
4000	Parameter data, administrated by fieldbus coupler	w ^{*)}	
5000	PROFIenergy parameter data, administrated by fieldbus coupler	w	
8000	ExpectedIdentificationData for one sub-slot	r	Submodule
8001	RealIdentificationData for one sub-slot	r	
800A	Diagnosis in channel coding	r	
800B	Diagnosis in all codings	r	
800C	Diagnosis, Maintenance, Qualified and Status	r	
8010	Maintenance required in channel coding	r	
8011	Maintenance demanded in channel coding	r	
8012	Maintenance required in all codings	r	
8013	Maintenance demanded in all codings	r	
8028	RecordInputDataObjectElement	r	
8029	RecordOutputDataObjectElement	r	
802A	PDPortDataReal	r	
802B	PDPortDataCheck	r/w	
802C	PDIRData for one subslot	r/w	

802D	Expected PDSyncData with SyncID value 0	r/w	
802F	PDPortDataAdjust	r/w	
8050	PDInterfaceMrpDataReal	r	
8051	PDInterfaceMrpDataCheck	r/w	
8052	PDInterfaceMrpDataAdjust	r/w	
8053	PDPortMrpDataAdjust	r/w	
8054	PDPortMrpDataReal	r	
8071	PDInterfaceAdjust	r/w	
8072	PDPortStatistic	r	
8080	PDInterfaceDataReal	r	
AFF0	I&M0	r	
AFF1	I&M1	r/w	
AFF2	I&M2	r/w	
AFF3	I&M3	r/w	
AFF4	I&M4	r/w	
C000	ExpectedIdentificationData for one slot	r	Module
C001	RealIdentificationData for one slot	r	
C00A	Diagnosis in channel coding	r	
C00B	Diagnosis in all codings	r	
C00C	Diagnosis, Maintenance, Qualified and Status	r	
C010	Maintenance required in channel coding	r	
C011	Maintenance demanded in channel coding	r	
C012	Maintenance required in all codings	r	
C013	Maintenance demanded in all codings	r	
E000	ExpectedIdentificationData for one AR	r	AR
E001	RealIdentificationData for one AR	r	
E00A	Diagnosis in channel coding	r	
E00B	Diagnosis in all codings	r	
E00C	Diagnosis, Maintenance, Qualified and Status	r	
E010	Maintenance required in channel coding	r	
E011	Maintenance demanded in channel coding	r	
E012	Maintenance required in all codings	r	
E013	Maintenance demanded in all codings	r	
E040	MultipleWrite	w	
F000	RealIdentificationData for one API	r	API
F00A	Diagnosis in channel coding	r	
F00B	Diagnosis in all codings	r	
F00C	Diagnosis, Maintenance, Qualified and Status	r	
F010	Maintenance required in channel coding	r	
F011	Maintenance demanded in channel coding	r	
F012	Maintenance required in all codings	r	
F013	Maintenance demanded in all codings	r	

F020	ARData for one API	r	Device
F80C	Diagnosis, Maintenance, Qualified and Status for one device	r	
F820	ARData	r	
F821	APIData	r	
F830	LogBookData	r	
F831	PdevData	r	
F840	I&M0FilterData	r	
F841	PDRealData	r	
F842	PDExpectedData	r	
FBFF	Trigger index for the RPC connection monitoring	r	

*) writable once for each connection

14.4 Detailed structures I&M 0-4

The following tables describe the I&M data sets 0-4 in detail.

Table 225: Data set I&M 0

N	Octet N	Octet N+1	Meaning generally	Meaning for the fieldbus coupler
0	0x00	0x20	Block type	Block type
2	0x00	0x38	Block length (without header)	Block length = 56 bytes
4	0x01	0x00	Block version	Block version 1.0
6	0x01	0x1D	Manufacturer ID	Manufacturer ID WAGO
8	0x37	0x35	Manufacturer specific item number (visible string, length 20 bytes)	Item number WAGO filled out with blanks "750-375 ..." or "750-377 ..."
10	0x30	0x2D		
12	0x33	0x37		
14	0x35	0x20		
16	0x20	0x20		
...		
26	0x20	0x20	Manufacturer specific production number (visible string, length 16 bytes)	MAC-ID WAGO filled out with blanks "0030DEKLMNOP ..."
28	0x30	0x30		
30	0x33	0x30		
32	0x44	0x45		
34	0xKK	0xLL		
36	0xMM	0xNN		
38	0xOO	0xPP		
40	0x20	0x20		
42	0x20	0x20		
44	0x00	0x01	IM hardware version	Hardware 01
46	0x56	0x01	IM software version	'V' 1.1.x (FW 01/02)
48	0x01	0xNN		'V' 2.1.x (FW 03)
50	0x00	0x01	IM version counter	
52	0x00	0x00	IM profile ID	IO device without profile implementation
54	0x00	0x05	IM profile specific type	Interface module
56	0x01	0x01	IM version 01.01	
58	0x00	0x1E	IM support	IM1 ... IM4 are supported

Table 226: Data set I&M 1

N	Octet N	Octet N+1	Meaning generally	Meaning for the fieldbus coupler
0	0x00	0x21	Block type	Block type
2	0x00	0x38	Block length (without header)	Block length = 56 Byte
4	0x01	0x00	Block version	Block version 1.0
6	?	?	I&M function (visible string, length 32 bytes)	User-specific function description filled out with blanks.
...		
36	?	?		
38	?	?	I&M location (visible string, length 22 bytes)	User-specific location for installation filled out with blanks.
...		
58	?	?		

Table 227: Data set I&M 2

N	Octet N	Octet N+1	Meaning generally	Meaning for the fieldbus coupler
0	0x00	0x22	Block type	Block type
2	0x00	0x12	Block length (without header)	Block length = 18 Byte
4	0x01	0x00	Block version	Block version 1.0
6	?	?	I&M function (visible string, length 16 bytes)	User-specific installation date filled out with blanks. The date ist formatted as follows: “YYYY-MM-DD HH:MM”
...		
20	?	?		

Table 228: Data set I&M 3

N	Octet N	Octet N+1	Meaning generally	Meaning for the fieldbus coupler
0	0x00	0x23	Block type	Block type
2	0x00	0x38	Block length (without header)	Block length = 56 Byte
4	0x01	0x00	Block version	Block version 1.0
6	?	?	I&M description (visible string, length 54 bytes)	User-specific description filled out with blanks.
...		
58	?	?		

Table 229: Data set I&M 4

N	Octet N	Octet N+1	Meaning generally	Meaning for the fieldbus coupler
0	0x00	0x24	Block type	Block type
2	0x00	0x38	Block length (without header)	Block length = 56 Byte
4	0x01	0x00	Block version	Block version 1.0
6	?	?	I&M signature (visible string, length 54 bytes)	User-specific security code filled out with blanks.
...		
58	?	?		

14.5 Structure of the Standardized Diagnosis Data Sets

The diagnosis data sets consist of several structures.

The first element in the data set is the head of the structure. It describes the version and the length of the following data. The "BlockType" specifies the structure and content of the data set. The following "BlockTypes" are used by the fieldbus coupler.

Table 230: "BlockTypes"

BlockType	Description
0x0010	Diagnostic data
0x8104	Real/expected configuration mismatch

The head of the structure has a length of 6 bytes and is structured as follows:

Table 231: Head of the structure

Byte offset	Data type		Description
0 / 1	WORD		Content of the "BlockType" data set
			0x0010 Diagnostic data set
			0x8104 Configuration data set specified/actual deviation
2 / 3	WORD		Length of the data set in bytes (BlockLength)
			Including length of the version in bytes
4/5	BYTE	0x01	BlockVersion (major) = 1
	BYTE		0x01 BlockVersion (minor) = 1

The version of the data set is 1.1. As a consequence the existing Application process identifier (API) is always set to zero (default API) and has a data length of 4 bytes.

14.5.1 Extended Channel Diagnostics

The "BlockType" in the head structure corresponds to the value for a diagnostic data set (0x0010). The length of the data set results from the following diagnostic objects for fault submodules or channels.

The diagnostic entries are initiated by a "ExtChannelDiagnosis" structure. The respective "ExtChannelDiagnosisData" diagnostic objects then follow for the respective submodules or channels. The "ExtChannelDiagnosis" structure has a size of 14 bytes and is structured as follows.

Table 232: „ExtChannelDiagnosis“ structure

Byte offset	Data type			Description
0 / 1 2 / 3	DWORD	0x00 0x00	0x00 0x00	API (Application Process Identifier) = 0
4 / 5	WORD			Slot-faulted module (SlotNumber) Value range 0 ... 250
6 / 7	WORD	0x00	0x01	Slot-faulted submodule (SubslotNumber)= 1
8 / 9	WORD	0x80	0x00	Diagnosis on submodule level (0x8000)
10 / 11	BYTE	0x08		Specification = Error pending (0x08)
	BYTE		0x00	Constant (0x00)
12 / 13	WORD			Diagnostic structure (UserStructureIdentifier) 0x8002 Extended channel diagnostics

The "UserstructureIdentifier" diagnostic structure carries the identifier for extended channel diagnostics (0x8002).

Each instance of the existing "ExtChannelDiagnosisData" diagnostic objects have a size of 12 bytes and is structured as follows.

Table 233: "ExtChannelDiagnosisData" instance structure

Byte offset	Data type			Description																																						
0 / 1	WORD			Diagnostic instance (ChannelNumber)																																						
				0x0000 ... 0x0007 Channel 0 ... 7 0x8000 Submodule																																						
2 / 3	WORD			Channel-/Submodule properties (ChannelProperties)																																						
				<table border="1"> <tr> <td>$2^7 \dots 2^0$</td> <td>Type</td> </tr> <tr> <td>0x00</td> <td>Instance = Submodule</td> </tr> <tr> <td>0x01</td> <td>1 bit</td> </tr> <tr> <td>0x02</td> <td>2 bit</td> </tr> <tr> <td>0x03</td> <td>4 bit</td> </tr> <tr> <td>0x04</td> <td>8 bit</td> </tr> <tr> <td>0x05</td> <td>16 bit</td> </tr> <tr> <td>0x06</td> <td>32 bit</td> </tr> <tr> <td>0x07</td> <td>64 bit</td> </tr> <tr> <td>0x08 ... 0xFF</td> <td>Reserved</td> </tr> <tr> <td>2^8</td> <td>No collective channel error = '0'</td> </tr> <tr> <td>$2^{10}, 2^9$</td> <td>Maintenance request = '00'</td> </tr> <tr> <td>$2^{12}, 2^{11}$</td> <td>Pending diagnosis = '01'</td> </tr> <tr> <td>$2^{15} \dots 2^{13}$</td> <td>Channel Properties, Direction</td> </tr> <tr> <td>'000'</td> <td>Manufacturer specific</td> </tr> <tr> <td>'001'</td> <td>Input</td> </tr> <tr> <td>'010'</td> <td>Output</td> </tr> <tr> <td>'011'</td> <td>Input/Output</td> </tr> <tr> <td>'100' ... '111'</td> <td>Reserved</td> </tr> </table>	$2^7 \dots 2^0$	Type	0x00	Instance = Submodule	0x01	1 bit	0x02	2 bit	0x03	4 bit	0x04	8 bit	0x05	16 bit	0x06	32 bit	0x07	64 bit	0x08 ... 0xFF	Reserved	2^8	No collective channel error = '0'	$2^{10}, 2^9$	Maintenance request = '00'	$2^{12}, 2^{11}$	Pending diagnosis = '01'	$2^{15} \dots 2^{13}$	Channel Properties, Direction	'000'	Manufacturer specific	'001'	Input	'010'	Output	'011'	Input/Output	'100' ... '111'	Reserved
$2^7 \dots 2^0$	Type																																									
0x00	Instance = Submodule																																									
0x01	1 bit																																									
0x02	2 bit																																									
0x03	4 bit																																									
0x04	8 bit																																									
0x05	16 bit																																									
0x06	32 bit																																									
0x07	64 bit																																									
0x08 ... 0xFF	Reserved																																									
2^8	No collective channel error = '0'																																									
$2^{10}, 2^9$	Maintenance request = '00'																																									
$2^{12}, 2^{11}$	Pending diagnosis = '01'																																									
$2^{15} \dots 2^{13}$	Channel Properties, Direction																																									
'000'	Manufacturer specific																																									
'001'	Input																																									
'010'	Output																																									
'011'	Input/Output																																									
'100' ... '111'	Reserved																																									
4 / 5	WORD			Channel Error Type																																						
				<table border="1"> <tr> <td>0x0000</td> <td>Reserved</td> </tr> <tr> <td>0x0001</td> <td>Short circuit</td> </tr> <tr> <td>0x0002</td> <td>Undervoltage</td> </tr> <tr> <td>0x0003</td> <td>Overvoltage</td> </tr> <tr> <td>0x0004</td> <td>Overload</td> </tr> <tr> <td>0x0005</td> <td>Overtemperature</td> </tr> <tr> <td>0x0006</td> <td>Line break</td> </tr> <tr> <td>0x0007</td> <td>Upper limit value exceeded</td> </tr> <tr> <td>0x0008</td> <td>Lower limit value undershot</td> </tr> <tr> <td>0x0009</td> <td>Error</td> </tr> <tr> <td>0x000A ... 0x000F</td> <td>Reserved</td> </tr> <tr> <td>0x0010</td> <td>Parameterization fault</td> </tr> </table>	0x0000	Reserved	0x0001	Short circuit	0x0002	Undervoltage	0x0003	Overvoltage	0x0004	Overload	0x0005	Overtemperature	0x0006	Line break	0x0007	Upper limit value exceeded	0x0008	Lower limit value undershot	0x0009	Error	0x000A ... 0x000F	Reserved	0x0010	Parameterization fault														
0x0000	Reserved																																									
0x0001	Short circuit																																									
0x0002	Undervoltage																																									
0x0003	Overvoltage																																									
0x0004	Overload																																									
0x0005	Overtemperature																																									
0x0006	Line break																																									
0x0007	Upper limit value exceeded																																									
0x0008	Lower limit value undershot																																									
0x0009	Error																																									
0x000A ... 0x000F	Reserved																																									
0x0010	Parameterization fault																																									

Table 233: "ExtChannelDiagnosisData" instance structure

Byte offset	Data type		Description
		0x0011	Power supply fault
		0x0012	Fuse blown/open
		0x0013	Communication fault
		0x0014	Upper user limit value exceed
		0x0015	Lower user limit value undershot
		0x0016	Sampling error
		0x0017	Threshold exceeded or fallen below
		0x0018	Output disabled
		0x0019	Safety event
		0x001A	External fault
		0x001B	Frame error
		0x001C	Cycle time error
		0x001D	Manufacturer specific
		...	
		0x001F	
		0x0020	Reserved for common profiles, e.g. PROFIsafe, see manuals of PROFIsafe V2 I/O modules
		...	
		0x004F	
		0x0050	Reserved for common profiles, e.g. PROFIsafe
		...	
		0x00FF	
		0x0100	Internal bus fault
		0x0101	Manufacturer specific
		...	
		0x01FF	
		0x0200	See manuals of PROFIsafe V2 I/O modules
		...	
		0x0220	
		0x0221	Manufacturer specific
		...	
		0x02FF	
		0x0300	See manual of 4-Channel IO-Link Master 75x-657
		...	
		0x031F	
		0x0320	See manuals of Analog Input Modules 75x-450 and 75x-451
		...	
		0x033F	
		0x0340	Manufacturer specific
		...	
		0x03EF	
		0x03F0	See manual of CAN Gateway 75x-658
		...	
		0x03FF	
		0x0400	See manual of Proportional Valve Module 750-632
		...	
		0x041F	
		0x0420	Manufacturer specific
		...	
		0x5080	
		0x5081	See manual of 4-Channel IO-Link Master 75x-657
		...	
		0x5801	

Table 233: "ExtChannelDiagnosisData" instance structure

Byte offset	Data type			Description
				0x5802 Manufacturer specific ... 0x7FFF
				0x8000 Data transmission impossible
				0x8001 Remote mismatch
				0x8002 Media redundancy mismatch
				0x8003 Sync mismatch
				0x8004 Isochronous Mode mismatch
				0x8005 Multicast CR mismatch
				0x8006 Reserved
				0x8007 Fiber optic mismatch
				0x8008 Network component function
				0x8009 Time mismatch
				0x800A Reserved ... 0xFFFF
6 / 7	WORD			Extended Channel Error Type
				0x0000 Extended error description, dependent on Error Type ... 0xFFFF
8 / 9 10 / 11	DWORD			Extended Channel Additional value
				0x00000000 Additional description to the error ... 0xFFFFFFFF

Errors in the internal data bus system are reported on the basis of manufacturer-specific error type 0x0100. Additional error information is available in the following table.

Table 234: Additional error information for Error Type "Internal bus fault"

Error Type "Internal bus fault (0x0100)"		
Extended Channel Error Type	Extended Channel Additional value	Description
0x0001	0x00000106	The module configuration that has been determined on the internal bus after AUTORESET differs from the configuration performed before the internal bus fault occurred.
0x0003	0x01100300	Internal bus protocol error due to internal bus RESET fault.
0x0003	0x01110300	Internal bus protocol error due to command fault.
0x0003	0x01120300	Internal bus protocol error due to faulty input data.
0x0003	0x01140300	Internal bus protocol error due to faulty output data.
0x0003	0x01180300	Internal bus protocol error caused by timeout.
0x0004	0x011204xx	Internal bus interruption after module slot xx (xx = 0 ... 250).
0x0005	0x011005xx	Internal bus initializing error because of an abortive register communication with the module on slot xx (xx = 1 ... 250).

All other errors are supplied with extended error type 0x0001 and additional value 0x00000000.

14.5.1.1 1.3.1.1 Fault Cases of I/O Modules with Diagnostics Capability

The following lists contain the respective error types and their meaning for I/O modules with diagnostics capability sorted by digital input/output modules, analog input/output modules and complex I/O modules.

14.5.1.1.1 Digital Input Modules

Table 235: Fault cases of digital input modules with diagnostics capability

Item number	Data format	Error type		Explanation
75x-418, 75x-419, 75x-421	BIT	0x001A / 26	External fault	Short circuit of the transmitter power supply
75x-425 75x-439	BIT	0x001A / 26	External fault	Signal line to transmitter interrupted or short circuit

14.5.1.1.2 Digital Output Modules

Table 236: Fault cases of digital output modules with diagnostics capability

Item number	Data format	Error type		Explanation
75x-506	BIT	0x0001 / 1	Short circuit	Signal output short circuit
		0x0002 / 2	Overvoltage	Field voltage to the signal output inadequate,
		0x0006 / 6	Line break	signal line to the actuator interrupted or not connected
75x-507, 75x-532, 75x-537	BIT	0x001A / 26	External fault	Short circuit of the signal output against +24V or GND, signal line to the actuator is interrupted or not connected or excess temperature through overloading.
75x-522, 750-523	BIT	0x001A / 26	External fault	External fault (broken wire, overload or short circuit, manual operation)

14.5.1.1.3 Analog Input Modules

Table 237: Fault cases of analog output modules with diagnostics capability

Item number	Data format	Error type		Explanation
75x-460, 75x-461, 75x-481 75x-469 75x-487	WORD	0x0006 / 6	Line break	Signal line to transmitter interrupted
		0x0008 / 8	Lower limit value undershot	Measurement range undershoot or signal line to the transmitter has a short circuit
		0x0009 / 9	Error	Internal error (e.g. hardware error)
75x-464	WORD	0x0001 / 1	Short circuit	Signal line to transmitter short circuit
		0x0006 / 6	Line break	Signal line to transmitter interrupted
		0x0007 / 7	Upper limit value exceeded	Upper measurement range end value exceeded
		0x0008 / 8	Lower limit value undershot	Lower measurement range end value undershot
		0x0009 / 9	Error	Internal error (e.g. hardware error)
		0x0014 / 20	Upper user limit value exceeded	Upper user limit value exceeded
		0x0015 / 21	Lower user limit value undershot	Lower user limit value undershot
75x-452, 75x-465, 75x-467, 75x-468, 75x-470 75x-472, 75x-475, 75x-477	WORD	0x0007 / 7	Upper limit value exceeded	Upper measurement range end value exceeded
		0x0009 / 9	Error	Internal error (e.g. hardware error)
75x-453, 75x-454, 75x-455, 75x-456, 75x-457, 75x-459, 75x-466, 75x-474, 75x-476, 75x-478, 75x-479, 75x-480, 75x-483, 75x-485, 75x-492	WORD	0x0007 / 7	Upper limit value exceeded	Upper measurement range end value exceeded
		0x0008 / 8	Lower limit value undershot	Lower measurement range end value undershot
		0x0009 / 9	Error	Internal error (e.g. hardware error)
75x-491	WORD	0x0003 / 3	Overvoltage	Maximum permissible bridge power supply
		0x0007 / 7	Upper limit value exceeded	Ovrange bridge voltage
		0x0009 / 9	Error	Internal error (e.g. hardware error)
75x-493	WORD	0x0002 / 2	Undervoltage	Low voltage threshold between L and N undershot
75x-494, 75x-495	OTHER	0x0009 / 9	Error	Error on at least one phase or I/O module faulty.

14.5.1.1.4 Analog Output Modules

Table 238: Fault cases of analog output modules with diagnostics capability

Item number	Data format	Error type		Explanation
75x-553, 75x-555, 75x-557, 75x-559, 75x-560	WORD	0x0009 / 9	Error	Output short circuit Internal error (e.g. hardware error)
75x-562, 75x-563	WORD	0x0001 / 1 0x0002 / 2 0x0005 / 5 0x0007 / 7 0x0008 / 8 0x0011 / 17	Short circuit Undervoltage Overtemperature Upper limit value exceeded Lower limit value undershot Sensor or load voltage missing	Output short circuit 24V field power below 20V Permissible temperature of output driver exceeded Configured limit value exceeded Configured limit value undershot Field voltage too low

14.5.1.1.5 Complex I/O Modules

Table 239: Fault cases of complex I/O modules with diagnostics capability

Item number	Data format	Error type		Explanation
750-606	BIT	0x0002 / 2 0x0011 / 17 0x001A / 26	Sensor or load voltage missing External fault	Output voltage too low Field voltage not present or too low Output voltage short circuit
750-610, 750-611	BIT	0x0011 / 17 0x0012 / 18	Sensor or load voltage missing Fuse defective	Field voltage too low or not present Fuse defective or not present
75x-630	DWORD	0x0016 / 22 0x001A / 26	Sampling error External fault	An incorrect data frame exists, i.e. the data frame is not terminated with zero (possible wire break of clock lines). SSI has no power supply or data line break, or D+ and D- have been inverted.
75x-635	OTHER	0x0009 / 9	Error	Wave speed not set or inadequate stop pulses or the maximum wave speed exceeded or timeout, no measurement values exist, measurement value invalid or error when setting the wave speed or zero point has occurred or invalid transmitter selection, the selected transmitter address is invalid because of the missing initialization
75x-636	OTHER	0x0009 / 9	Error	Status/error message.
75x-637	OTHER	0x00011 / 17	Sensor or load voltage missing	Loss of field power
75x-641	OTHER	0x0009 / 9 0x001A / 26	Error External fault	General module error, e.g. POST of the internal flash memory, DALI bus error (continuous short circuit or open circuit), but no faulty electronic ballasts.
75x-642, 75x-650, 75x-651, 75x-652 75x-653	OTHER	0x0007 / 7	Upper limit value exceeded	The receiver buffer is completely full, there is a danger of loss of data
75x-643	OTHER	0x0009 / 9	Error	Internal error (e.g. hardware error)
75x-644	OTHER	0x0009 / 9	Error	Non-existent or invalid process data
75x-645	OTHER	0x0009 / 9 0x001A / 26	Error External fault	Internal error, e.g. hardware defect External error (line break or short circuit)
75x-655	OTHER	0x00011 / 172 0x0009 / 9 0x001D / 29	Sensor or load voltage missing Error Bus communication faulty	Field power and/or AS-I supply faulty Field power and/or AS-I supply faulty and AS interface master inactive AS interface master inactive
75x-670 75x-671 75x-672 75x-673	OTHER	0x0009 / 9	Error	Error present.

14.5.1.1.6 PROFIsafe V2 iPar I/O Modules

Item number:

75x-661/000-003,
75x-662/000-003,
75x-663/000-003,
75x-666/000-003,
75x-667/000-003

The fault cases of the PROFIsafe V2 iPar I/O modules are described in detail in the manuals for the respective I/O modules.

Information



More information on the PROFIsafe V2 iPar I/O modules!

Detailed information on the PROFIsafe V2 iPar I/O modules and their fault case descriptions is available in the I/O module manuals. They are available to download from the WAGO website at: www.wago.com.

14.5.2 Difference between Real and Expected Configuration

The fieldbus coupler provides diagnostic information in the event of module differences in the form of a "ModuleDiffBlock" when there are deviations between the module/submodule configuration of the IO controller and the IO modules actually connected.

The "BlockType" in the head structure of the data set corresponds to the value for module differences (0x8104). The length gives information on the differences between the configured and connected modules/submodules.

The "ModuleDiffBlock" is initiated with the following head structure.

Table 240: Initial structure "ModuleDiffBlock"

Byte offset	Data type			Description
0 / 1	WORD	0x00	0x01	Number of available APIs = 1
2 / 3 4 / 5	DWORD	0x00 0x00	0x00 0x00	API (Application Process Instance) = 0
6 / 7	WORD			Number of slots with differences between real and expected configuration
				Depends on the amount of following entries

The entries for the incorrectly configured modules/submodules then follow. The number of existing entries is stored in the preliminary structure of the "ModuleDiffBlock".

Table 241: Structure of the odd modules within the configuration

Byte offset	Data type			Description
0 / 1	WORD			Slot with odd module
				Range 1 ... 255
2 / 3 4 / 5	DWORD			Identification of the physically plugged module ("ModuleIndentNumber")
6 / 7	WORD			Module state
				0x0000 Module not plugged
				0x0001 ModuleIndentNumber wrong
				0x0002 Module is okay, but at least one submodule is locked, wrong or missing
				0x0003 Module is not the same as requested – but the IO device was able to adapt by its own knowledge
				0x0004 ... 0xFFFF Reserved
8 / 9	WORD			Number of submodule slots with odd submodules, otherwise 0

The entries for the incorrectly configured submodules follow a module entry.

Table 242: Structure of the erroneously configured submodules

Byte offset	Data type			Description
0 / 1	WORD	0x00	0x01	Subslot with odd submodule
2 / 3 4 / 5	DWORD	0x00 0x00	0x00 0x00	Identification of the plugged submodule (SubmoduleIdentNumber)
6 / 7	WORD			Submodule state (Submodulstate.b15 = 0)
				0x0000 No submodule present
				0x0001 Wrong submodule
				0x0002 Submodule locked by IO controller
				0x0003 Reserved
				0x0004 Application ready pending
				0x0005 Reserved
				0x0006 Reserved
				0x0007 Submodule substituted
				0x0008 ... Reserved
				0x7FFF
8 / 9	WORD			Submodule state (Submodule state.b15 = 1)
				b0 '000' ---
				'001' The submodule is not available for takeover by IOSAR.
				... '010' ... Reserved
				b2 ... '111'
				b3 0 No channel of the submodule contains "QualifiedChannelDiagnosis".
				1 At least one channel of the submodule contains "QualifiedChannelDiagnosis".
				b4 0 No channel of the submodule requires maintenance.
				1 At least one channel of the submodule demands maintenance.
				b5 0 No channel of the submodule demands maintenance.
				1 At least one submodule channel demands maintenance.
				b6 0 There is no diagnosis data available/stored for this submodule.
				1 There is diagnosis data available for this submodule: It can be read with the corresponding records.

			b7	'0000'	This AR is owner of the submodule.
			...	'0001'	This AR is owner of the submodule but it is blocked, e.g. parameter checking is pending.
			b10	'0010'	This AR is not owner of the submodule. It is blocked by superordinated means.
			...	'0011'	This AR is not owner of the submodule. It is owned by another IOCAR.
			b11	'0100'	This AR is not owner of the submodule. It is owned by another IOCAR.
			...	'0101'	Reserved
			b14	'1111'	Reserved
			b11	'0000'	Submodule OK
			...	'0001'	Submodule substituted
			b14	'0010'	Wrong submodule
			...	'0011'	No submodule present
			b14	'0100'	Reserved
			...	'1111'	Reserved
			b15	1	Format indicator
					Reserved

The submodule entries follow directly one after the other. The number stored in the module entry. The next module entry only follows after the submodule data sets.

List of Figures

Figure 1: Fieldbus node (example).....	19
Figure 2: Labeling on the side of a component.....	20
Figure 3: Example of a manufacturing number.....	20
Figure 4: Isolation for fieldbus couplers/controllers (example).....	23
Figure 5: System supply for standard fieldbus coupler/controller and extended ECO couplers	24
Figure 6: System voltage for standard couplers/controllers and extended ECO couplers	25
Figure 7: Field supply for standard couplers/controllers and extended ECO couplers	28
Figure 8: Supply module with fuse carrier (Example 750-610).....	30
Figure 9: Removing the fuse carrier.....	31
Figure 10: Opening the fuse carrier.....	31
Figure 11: Change fuse.....	31
Figure 12: Fuse modules for automotive fuses, series 282	32
Figure 13: Fuse modules for automotive fuses, series 2006	32
Figure 14: Fuse modules with pivotable fuse carrier, series 281	32
Figure 15: Fuse modules with pivotable fuse carrier, series 2002	32
Figure 16: Power supply concept	33
Figure 17: Supply example for standard couplers/controllers and extended ECO couplers	34
Figure 18: Carrier rail contact (example).....	38
Figure 19: Example of the WAGO shield connecting system	40
Figure 20: Application of the WAGO shield connecting system.....	40
Figure 21: View Fieldbus coupler PROFINET IO advanced	45
Figure 22: Device Supply	47
Figure 23: RJ-45 Connector	48
Figure 24: Display Elements	49
Figure 25: Display Elements Fieldbus Connection RJ-45	50
Figure 26: Service Interface (closed and opened flap).....	51
Figure 27: DIP Switch (for example setting “0“).....	52
Figure 28: Spacing.....	63
Figure 29: Unlocking lug standard fieldbus coupler/controller (example)	66
Figure 30: Unlocking lug of extended ECO fieldbus coupler (example).....	66
Figure 31: Unlocking lug ECO coupler	67
Figure 32: Insert I/O module (sample).....	68
Figure 33: Snap the I/O module into place (sample).....	68
Figure 34: Removing the I/O module (sample).....	69
Figure 35: Data contacts.....	70
Figure 36: Example for the arrangement of power contacts	71
Figure 37: Connecting a conductor to a CAGE CLAMP®	72
Figure 38: Fieldbus coupler operating system	74
Figure 39: Allocation of the Input and Output Data	77
Figure 40: Output process data in the frame IOC → IOD	83
Figure 41: Input process data in the frame IOD → IOC	83
Figure 42: Exemplary maximum configuration	85
Figure 43: Exemplary usage of physical option modules	85
Figure 44: Exemplary usage of virtual option modules	86

Figure 45: Usage of option module without physical slot reservation.....	86
Figure 46: Usage of option module with physical slot reservation.....	87
Figure 47: iPar Server.....	91
Figure 48: Structure of WBM pages, example: WBM page "Information"	107
Figure 49: WBM pages – Status area.....	108
Figure 50: WBM page „Information“	109
Figure 51: WBM page "Ethernet"	110
Figure 52: WBM page „TCP/IP“	111
Figure 53: WBM page "Diagnostics"	112
Figure 54: WBM page "Administration"	112
Figure 55: Display Elements	114
Figure 56: Display Elements Fieldbus Connection RJ-45	114
Figure 57: Node status - I/O LED signaling.....	118
Figure 58: Error message coding.....	118
Figure 59: PROFINET principle	133
Figure 60: Side marking example for approved I/O modules according to ATEX and IECEEx	139
Figure 61: Text detail – Marking example for approved I/O modules according to ATEX and IECEEx.	139
Figure 62: Side marking example for approved Ex i I/O modules according to ATEX and IECEEx.	141
Figure 63: Text detail – Marking example for approved Ex i I/O modules according to ATEX and IECEEx.	141
Figure 64: Side marking example for I/O modules according to NEC 500	144
Figure 65: Text detail – Marking example for approved I/O modules according to NEC 500.....	144

List of Tables

Tabelle 1: Variations	9
Table 2: Number notation.....	12
Table 3: Font conventions	12
Table 4: Abbreviations and terms used in this manual	13
Table 5: Alignment.....	25
Table 6: Caption for “ Field supply (sensor/actuator) for standard couplers/controllers and extended ECO couplers”	28
Table 7: Power supply modules	30
Table 8: Filter modules for 24 V supply	33
Table 9: Caption for figure “Supply example for fieldbus coupler/controller”	35
Table 10: WAGO Power Supply Unit (Selection)	36
Table 11: WAGO ground wire terminals	37
Table 12: PROFINET IO properties and specifications.....	43
Table 13: Legend to the View PROFINET IO advanced Fieldbus Coupler	46
Table 14: RJ-45 Connector and RJ-45 Connector Configuration	48
Table 15: Display Elements Fieldbus Status	49
Table 16: Display Elements Node Status	49
Table 17: Display Elements Supply Voltage	49
Table 18: Display Elements Fieldbus Connection RJ-45.....	50
Table 19: Legend for figure “Service Interface (closed and opened flap)	51
Table 20: DIP switch - Explanation of the 8 slide switches.....	53
Table 21: Example DIP switch setting	54
Table 22: Technical data – Device data	55
Table 23: Technical data – System data	56
Table 24: Technical data – Supply	56
Table 25: Technical Data – Accessories	56
Table 26: Technical Data – Field Wiring.....	56
Table 27: Technical Data – Power Jumper Contacts	56
Table 28: Technical Data – Internal Bus.....	57
Table 29: Technical Data – Climatic environmental conditions.....	57
Table 30: WAGO DIN Rail.....	63
Table 31: Identification and Maintenance Data Sets (I&M).....	75
Table 32: Example 1 for process data qualifiers for 2-channel digital input modules without diagnostics and with 1-bit diagnostics and diagnostic acknowledgement.	78
Table 33: Example 2 for process data qualifiers for 2-channel digital output modules with diagnostics	79
Table 34: Example 3 for process data qualifiers for 2-channel analog input and output modules.....	79
Table 35: Example 4 for process data qualifiers for special-purpose modules, SSI sensor interface	79
Table 36: Example for a station with the following selected submodules.....	83
Tabelle 37: Real identification of option module slots	88
Table 38: Legend for the iPar server figure	91
Table 39: Parameterization – Overview of attributes for the station proxy (DAP)	100
Table 40: Parameterization DAP – Attribute Restart on K-Bus failure	100

Table 41: Parameterization DAP – Attribute Diagnostics of external module/channel errors.....	100
Table 42: Parameterization DAP – Attribute Internal data bus extension	100
Table 43: Parameterization DAP – Attribute Response to PROFINET IO failure	101
Table 44: Parameterization DAP – Attribute Response to K-Bus failure	101
Table 45: Parameterization DAP – Attribute Webserver	101
Table 46: Parameterization DAP – Attribute WAGO-Service (TCP Port 6626)	101
Table 47: Parameterization DAP – Attribute Minimal pause time (PROFIenergy)	102
Table 48: Send cycle time as a function of RT class, transmit clocking and scaling factor	105
Table 49: Legend for the indicators in the status area.....	108
Table 50: Parameter description of WBM page "Information"	109
Table 51: Description of the parameters of the WBM page "Ethernet"	110
Table 52: Description of the parameters of the WBM page "TCP/IP"	111
Table 53: Parameter description of the WBM page "Administration"	112
Table 54: LED assignment for diagnostics	114
Table 55: Fieldbus diagnostics – solution in event of error	115
Table 56: Diagnostics of the fieldbus status on the fieldbus connection – solution in event of error.....	116
Table 57: Node status diagnostics – Solution in event of error.....	117
Table 58: Blink code- table for the I/O LED signaling, error code 1.....	119
Table 59: Blink code table for the I/O LED signaling, error code 2.....	120
Table 60: Blink code table for the I/O LED signaling, error code 3.....	121
Table 61: Blink code table for the I/O LED signaling, error code 4.....	122
Table 62: Blink code table for the I/O LED signaling, error code 5.....	122
Table 63: Blink code table for the 'I/O' LED signaling, error code 6	123
Table 64: Blink code table for the 'I/O' LED signaling, error code 7...8	123
Table 65: Blink code table for the I/O LED signaling, error code 9.....	123
Table 66: Blink code table for I/O LED signaling, error code 10...11	123
Table 67: Blink code table for I/O LED signaling, error code 12.....	123
Table 68: Power supply status diagnostics – solution in event of error	124
Table 69: Diagnosis of fieldbus failure	125
Table 70: Retrievable record data sets for diagnostics.....	126
Table 71: Structure head for the diagnostic data.....	127
Table 72: Description of marking example for approved I/O modules according to ATEX and IECEx	140
Table 73: Description of marking example for approved Ex i I/O modules according to ATEX and IECEx	142
Table 74: Description of marking example for approved I/O modules according to NEC 500.....	144
Table 75: Module types – Digital Input Modules	151
Table 76: Submodule types and data lengths – Digital Input Modules.....	153
Table 77: Module types – Digital Output Modules.....	155
Table 78: Submodule types and data lengths – Digital Output Modules.....	157
Table 79: Module types – Digital Input/Output Modules	159
Table 80: Submodule types and data lengths – Digital Input/Output Modules ..	160
Table 81: Module types – Analog Input Modules.....	160
Table 82: Submodule types and data lengths – Analog Input Modules.....	161

Table 83: Module types – Analog Output Modules	162
Table 84: Submodule types and data lengths – Analog Output Modules	162
Table 85: Module types – Up/Down Counter	163
Table 86: Submodule types and data lengths – Up/Down Counter	163
Table 87: Module types – 2-Channel Pulse Width Output Modules	164
Table 88: Submodule types and data lengths – 2-Channel Pulse Width Output Module	164
Table 89: Module types – Distance and Angle Measurement Modules.....	164
Table 90: Submodule types and data lengths – Distance and Angle Measurement Modules.....	165
Table 91: Modultypen – Serial Interfaces	165
Table 92: Submodule types and data lengths – Serial Interfaces	165
Table 93: Module types – DC-Drive Controller	166
Table 94: Submodule types and data lengths – DC-Drive Controller.....	166
Table 95: Module types – RTC Module.....	166
Table 96: Submodule types and data lengths – RTC Module.....	167
Table 97: Module types – DALI/DSI Master and DALI Multi-Master Modules	167
Table 98: Submodule types and data lengths – DALI/DSI Master and DALI Multi-Master Modules	167
Table 99: Module types – AS-Interface Master Modules	167
Table 100: Submodule types and data lengths – AS-Interface Master Modules	168
Table 101: Module types – RF Modules	168
Table 102: Submodule types and data lengths – RF Modules	169
Table 103: Module types – MP-Bus Master Modules	169
Table 104: Submodule types and data lengths – MP-Bus Master Modules.....	169
Table 105: Module types – Vibration Monitoring	169
Table 106: Submodule types and data lengths – Vibration Monitoring.....	170
Table 107: Module types – Safety Modules PROFIsafe V2	170
Table 108: Submodule types and data lengths – Safety Modules PROFIsafe V2 iPAR.....	170
Table 109: Module types – Stepper Modules.....	170
Table 110: Submodule types and data lengths – Stepper Modules.....	171
Table 111: Module types – Power Supply Modules	172
Table 112: Submodule types and data lengths– Power Supply Modules.....	172
Table 113: Parameterization – Overview of Attributes for Digital Input Modules with Diagnostics (DI, DIA).....	173
Table 114: Parameterization DI, DIA – Attributes "Channel diagnosis"	173
Table 115: Parameterization DI, DIA – Attributes "Diagnosis: External fault" .	173
Table 116: Parameterization – Overview of Attributes for Digital Output Modules (DO)	174
Table 117: Parameterization DO – Attributes "Substitute value behavior"	174
Table 118: Parameterization DO – Attribute "Substitute value (1 Byte)"	174
Table 119: Parameterization – Overview of Additional Attributes for Digital Output Modules with Diagnostics (DO, DIA).....	175
Table 120: Parameterization DO, DIA – Attribute "Channel diagnosis"	175
Table 121: Parameterization DO, DIA – Attribute "Diagnosis: External fault" .	175
Table 122: Parameterization DO, DIA – Attribute "Diagnosis: Short circuit" ...	175
Table 123: Parameterization DO, DIA – Attribute "Diagnosis: Line break"	176
Table 124: Parameterization – Overview of Additional Attributes for PROFIenergy Submodules (DO, PE)	176

Table 125: Parameterization DO, PE – Attribute "Minimal pause time"	176
Table 126: Parameterization DO, PE – Attribute "Pause output state"	176
Table 127: Parameterization – Overview of Attributes for Analog Input Modules (AI).....	177
Table 128: Parameterization AI – Attribute "Channel diagnosis"	177
Table 129: Parameterization AI – Attribute "Diagnosis: External fault"	177
Table 130: Parameterization AI – Attribute "Diagnosis: Measuring range overflow"	178
Table 131: Parameterization AI – Attribute "Diagnosis: Measuring range underflow"	178
Table 132: Parameterization AI – Attribute "Diagnosis: Line break"	178
Table 133: Parameterization AI – Attribute "Diagnosis: Short circuit"	178
Table 134: Parameterization AI – Attribute "Diagnosis: Lower limit value exceeded"	179
Table 135: Parameterization AI – Attribute "Diagnosis: Upper limit value exceeded"	179
Table 136: Parameterization AI – Attribute "Lower user limit"	179
Table 137: Parameterization AI – Attribute "Upper user limit"	179
Table 138: Parameterization – Overview of Additional Attributes for Special AI Module Types (2/4 AI, RTD, TC)	180
Table 139: Parameterization 2AI, RTD, TC – Attribute "User scaling"	180
Table 140: Parameterization 2AI, RTD, TC – Attribute "User offset"	180
Table 141: Parameterization 2AI, RTD, TC – Attribute "User gain"	180
Table 142: Parameterization 2AI, RTD, TC – Attribute "Vendor scaling"	180
Table 143: Parameterization 2AI, RTD, TC – Attribute "Watchdog timer"	180
Table 144: Parameterization 2AI, RTD, TC – Attribute "Vendor scaling"	181
Table 145: Parameterization 2AI, RTD, TC – Attribute "Status flags"	181
Table 146: Parameterization 2AI, RTD, TC – Attribute "Filter"	181
Table 147: Parameterization AI, RTD 461– Attribute "Filter constant"	181
Table 148: Parameterization AI, RTD 481– Attribute "Filter constant"	181
Table 149: Parameterization AI, TC – Attribute "Filter constant"	181
Table 150: Parameterization 2AI, RTD 461, 481 – Attribute "Sensor type"	182
Table 151: Parameterization 2AI, RTD – Attribute "Overrange protection"	182
Table 152: Parameterization 2AI, RTD 463 – Attribute "Sensor type"	183
Table 153: Parameterization 4AI, RTD 464 – Attribute "Sensor type"	183
Table 154: Parameterization 4AI, RTD 464/020-000 – Attribute "Sensor type"	183
Table 155: Parameterization 2AI, RTD 464 – Attribute "Connection type"	183
Table 156: Parameterization AI, PM 494 – Attribute "DC measurement"	183
Table 157: Parameterization 2AI, RTD 461, 481 – Attribute "Connection type"	183
Table 158: Parameterization 2AI, TC – Attribute "Sensor type"	184
Table 159: Parameterization AI, TC – Attribute "Wire break detection"	184
Table 160: Parameterization AI, TC – Attribute "Check lower measurement range limit"	185
Table 161: Parameterization AI, TC – Attribute "Cold junction compensation"	185
Table 162: Parameterization AI, 3 PM – Attribute "Watchdog"	185
Table 163: Parameterization AI, 3 PM – Attribute "Nom. frequency power supply"	185
Table 164: Parameterization AI, 3 PM 495 – Attribute "Identifier Rogowski coils"	185

Table 165: Parameterization AI, 3 PM – Attribute "Peak value phase"	185
Table 166: Parameterization AI, 3 PM – Attribute "Autoreset min./max. value"	185
Table 167: Parameterization AI, 3 PM – Attribute "User scaling"	186
Table 168: Parameterization AI, 3 PM – Attribute "Scaling energy consumption"	186
Table 169: Parameterization AI, 3 PM – Attribute "Scaling energy consumption"	186
Table 170: Parameterization AI, 3 PM – Attribute "Storage interval energy [s]"	186
Table 171: Parameterization AI, 3 PM – Attribute "Current transformer ratio".	186
Table 172: Parameterization AI, 3 PM – Attribute "Peak value meas. interval [HW]".....	186
Table 173: Parameterization AI, 3 PM – Attribute "Min./Max. reset interval [200ms]".....	187
Table 174: Parameterization – Overview of Attributes for Analog Output Modules (AO).....	187
Table 175: Parameterization AO – Attribute "Substitute value behavior".....	187
Table 176: Parameterization AO – Attribute "Substitute value (2 Byte)"	188
Table 177: Parameterization – Overview of additional Attributes for Analog Output Modules with Diagnostics (AO, DIA).....	188
Table 178: Parameterization AO, DIA – Attribute "Channel diagnosis".....	188
Table 179: Parameterization AO, DIA – Attribute "Diagnosis: Short circuit" ...	188
Table 180: Parameterization AO, DIA – Attribute "Diagnosis: Undervoltage" .	188
Table 181: Parameterization AO, DIA – Attribute "Diagnosis: Overtemperature"	189
Table 182: Parameterization AO, DIA – Attribute "Diagnosis: Error".....	189
Table 183: Parameterization AO, DIA – Attribute "Diagnosis: External fault" .	189
Table 184: Parameterization – Overview of Additional Attributes for Special AO Module Types with Parameter Channel(AO, 562, 563)	190
Table 185: Parameterization AO, 562, 563 – Attribute "User scaling"	190
Table 186: Parameterization AO, 562, 563 – Attribute "Calibration"	190
Table 187: Parameterization AO, 562, 563 – Attribute "Number representation"	190
Table 188: Parameterization AO, 562, 563 – Attribute "Operating mode"	190
Table 189: Parameterization AO, 562, 563 – Attribute "On exceeding user limits"	190
Table 190: Parameterization AO, 562, 563 – Attribute "Output"	191
Table 191: Parameterization AO, 562, 563 – Attribute "Behavior on K-Bus timeout".....	191
Table 192: Parameterization AO, 562, 563 – Attribute "Switch-on delay [s]" ...	191
Table 193: Parameterization – Overview of Additional Attributes for PROFInergy Submodules (AO, PE)	191
Table 194: Parameterization AO, PE – Attribute "Minimal pause time".....	192
Table 195: Parameterization DO, PE – Attribute "Pause output value"	192
Table 196: Parameterization SF, DIA – Attribute "Channel diagnosis"	192
Table 197: Parameterization SF, DIA – Attribute "Diagnosis: External fault" ..	192
Table 198: Parameterization SF, DIA – Attribute "Diagnosis: Error"	193
Table 199: Parameterization SF, DIA – Attribute "Diagnosis: Undervoltage" ...	193

Table 200: Parameterization SF, SSI 630 – Attribute "Diagnosis: Sampling error"	193
Table 201: Parameterization SF, ENC – Attribute "Diagnosis: Upper limit value exceeded"	193
Table 202: Parameterization SF, ENC – Attribute "Sensor or load voltage missing"	193
Table 203: Parameterization SF, ASi – Attribute "Diagnosis: Bus fault"	194
Table 204: Parameterization SF, SSI 630 – Attribute "Baud rate [kHz]"	194
Table 205: Parameterization SF, SSI 630 – Attribute "SSI frame"	194
Table 206: Parameterization SF, SSI 630 – Attribute "SSI clocks"	194
Table 207: Parameterization SF, SSI 630 – Attribute "Relevant data length [bit]"	194
Table 208: Parameterization SF, SSI 630 – Attribute Synchronous operation ...	194
Table 209: Parameterization SF, SSI 630 – Attribute "Gray-Dual code conversion"	194
Table 210: Parameterization SF, SSI 630 – Attribute "Single-turn evaluation"	195
Table 211: Parameterization SF, SSI 630 – Attribute "Disable frame error detection"	195
Table 212: Parameterization SF, SER – Attribute "Transmission rate area [baud]"	195
Table 213: Parameterization SF, SER – Attribute "Transmission rate [baud]" ..	195
Table 214: Parameterization SF, SER – Attribute "Data frame"	195
Table 215: Parameterization SF, ASi 655, BT 644 – Attribute "Mailbox length"	196
Table 216: Parameterization SF, ASi 655, BT 644 – Attribute "Cross-fading of mailbox"	196
Table 217: Parameterization SF, ASi 655 – Attribute "Use of free PI areas"	196
Table 218: Parameterization – Overview of Attributes for System Modules with Diagnostics (PS, DIA)	196
Table 219: Parameterization PS, DIA – Attribute "Module diagnosis"	197
Table 220: Parameterization PS, DIA – Attribute "Sensor or load voltage missing"	197
Table 221: Parameterization PS, 750-610, 750-611 – Attribute "Diagnosis: Fuse blown/open"	197
Table 222: Parameterization PS, 750-606 – Attribute "Diagnosis: Undervoltage"	197
Table 223: Parameterization PS, 750-606 – Attribute "Diagnosis: External fault"	198
Table 224: Record data sets	198
Table 225: Data set I&M 0	200
Table 226: Data set I&M 1	201
Table 227: Data set I&M 2	201
Table 228: Data set I&M 3	201
Table 229: Data set I&M 4	201
Table 230: "BlockTypes"	202
Table 231: Head of the structure	202
Table 232: „ExtChannelDiagnosis“ structure	203
Table 233: "ExtChannelDiagnosisData" instance structure	204
Table 234: Additional error information for Error Type "Internal bus fault"	206
Table 235: Fault cases of digital input modules with diagnostics capability	207

Table 236: Fault cases of digital output modules with diagnostics capability	207
Table 237: Fault cases of analog output modules with diagnostics capability ...	208
Table 238: Fault cases of analog output modules with diagnostics capability ...	209
Table 239: Fault cases of complex I/O modules with diagnostics capability	210
Table 240: Initial structure "ModuleDiffBlock"	211
Table 241: Structure of the odd modules within the configuration.....	212
Table 242: Structure of the erroneously configured submodules.....	213

WAGO Kontakttechnik GmbH & Co. KG
Postfach 2880 • D-32385 Minden
Hansastraße 27 • D-32423 Minden
Phone: +49/5 71/8 87 – 0
Fax: +49/5 71/8 87 – 1 69
E-Mail: info@wago.com
Internet: <http://www.wago.com>

