



CY8CKIT-029 PSoC[®] LCD Segment Drive Expansion Board Kit Guide

Doc. # 001-55415 Rev. *B

Cypress Semiconductor
198 Champion Court
San Jose, CA 95134-1709
Phone (USA): 800.858.1810
Phone (Intl): 408.943.2600
<http://www.cypress.com>

Copyrights

© Cypress Semiconductor Corporation, 2009. The information contained herein is subject to change without notice. Cypress Semiconductor Corporation assumes no responsibility for the use of any circuitry other than circuitry embodied in a Cypress product. Nor does it convey or imply any license under patent or other rights. Cypress products are not warranted nor intended to be used for medical, life support, life saving, critical control or safety applications, unless pursuant to an express written agreement with Cypress. Furthermore, Cypress does not authorize its products for use as critical components in life-support systems where a malfunction or failure may reasonably be expected to result in significant injury to the user. The inclusion of Cypress products in life-support systems application implies that the manufacturer assumes all risk of such use and in doing so indemnifies Cypress against all charges.

Any Source Code (software and/or firmware) is owned by Cypress Semiconductor Corporation (Cypress) and is protected by and subject to worldwide patent protection (United States and foreign), United States copyright laws and international treaty provisions. Cypress hereby grants to licensee a personal, non-exclusive, non-transferable license to copy, use, modify, create derivative works of, and compile the Cypress Source Code and derivative works for the sole purpose of creating custom software and or firmware in support of licensee product to be used only in conjunction with a Cypress integrated circuit as specified in the applicable agreement. Any reproduction, modification, translation, compilation, or representation of this Source Code except as specified above is prohibited without the express written permission of Cypress.

Disclaimer: CYPRESS MAKES NO WARRANTY OF ANY KIND, EXPRESS OR IMPLIED, WITH REGARD TO THIS MATERIAL, INCLUDING, BUT NOT LIMITED TO, THE IMPLIED WARRANTIES OF MERCHANTABILITY AND FITNESS FOR A PARTICULAR PURPOSE. Cypress reserves the right to make changes without further notice to the materials described herein. Cypress does not assume any liability arising out of the application or use of any product or circuit described herein. Cypress does not authorize its products for use as critical components in life-support systems where a malfunction or failure may reasonably be expected to result in significant injury to the user. The inclusion of Cypress' product in a life-support systems application implies that the manufacturer assumes all risk of such use and in doing so indemnifies Cypress against all charges.

Use may be limited by and subject to the applicable Cypress software license agreement.

PSoC[®] Creator[™] is a trademark and PSoC[®] is a registered trademark of Cypress Semiconductor Corp. All other trademarks or registered trademarks referenced herein are property of the respective corporations.

Flash Code Protection

Cypress products meet the specifications contained in their particular Cypress PSoC Data Sheets. Cypress believes that its family of PSoC products is one of the most secure families of its kind on the market today, regardless of how they are used. There may be methods, unknown to Cypress, that can breach the code protection features. Any of these methods, to our knowledge, would be dishonest and possibly illegal. Neither Cypress nor any other semiconductor manufacturer can guarantee the security of their code. Code protection does not mean that we are guaranteeing the product as "unbreakable."

Cypress is willing to work with the customer who is concerned about the integrity of their code. Code protection is constantly evolving. We at Cypress are committed to continuously improving the code protection features of our products.

Contents



1. Introduction	5
1.1 Kit Contents	5
1.2 PSoC Creator	5
1.3 Getting Started.....	6
1.4 Additional Learning Resources.....	6
1.5 Document History	6
1.6 Document Conventions	6
2. Installation	7
2.1 CD Installation	7
2.2 Install Hardware.....	8
2.3 Install Software	8
3. Kit Operation	9
3.1 Introduction	9
3.2 Programming PSoC 3 Device.....	9
3.3 Hardware Connections	12
3.4 Verify the Output.....	13
4. Hardware	15
4.1 System Block Diagram	15
4.2 Functional Description	16
4.2.1 LCD Glass Details.....	16
4.2.1.1 Pixel Mapping Table	16
4.2.1.2 Glass Specification	17
4.3 Port Options with CY8CKIT-001 DVK.....	17
4.4 Power Supply.....	19
5. Example Projects	21
5.1 Example Project 1: LCD_Seg_Example1_Battery_Meter	21
5.1.1 Project Description	21
5.1.2 Running the Example Project.....	21
5.1.3 Hardware Connections.....	21
5.1.4 Verifying Output.....	21
5.1.5 PSoC Creator Project Details.....	22
5.1.5.1 LCD_Seg	22
5.1.5.2 ADC_DeISig.....	26
5.1.5.3 VR.....	26
5.2 Example Project 2: LCD_Seg_Example2_StopWatch	27
5.2.1 Project Description	27
5.2.2 Running the Example Project.....	28
5.2.3 Hardware Connections.....	28

5.2.4	Verifying the Output	29
5.2.5	PSoC Creator Project Details	30
5.2.5.1	LCD_Seg	31
5.2.5.2	Real Time Clock (RTC)	34
5.2.5.3	Status Register	34
5.2.5.4	Sw_Sample_Clock	35
5.2.5.5	Clock_SW	36
A. Appendix		39
A.1	Schematic	39
A.2	Board Layout	40
A.2.1	PDCR-09571 Top View	40
A.2.2	PDCR-09571 Bottom View	40
A.3	BOM	41

1. Introduction



The CY8CKIT-029 PSoC[®] LCD Segment Drive Expansion Board Kit (EBK) is an expansion board that is used in conjunction with CY8CKIT-001. It allows you to evaluate PSoC's LCD drive capability by designing your own projects with easy-to-use LCD segment component in Cypress's PSoC Creator[™], or altering sample projects provided with this kit.

The CY8CKIT-029 PSoC LCD Segment Drive EBK is based on the PSoC family of devices. PSoC is a programmable system-on-chip platform for 8, 16, and 32-bit applications. It combines precision analog and digital logic with a high performance 8051 single cycle per instruction pipelined processor, achieving 10 times the performance of previous 8051 processors. With PSoC, you can create the exact combination of peripherals and integrated proprietary IP to meet the needs of your applications. You are no longer constrained by a catalog.

1.1 Kit Contents

This kit contains:

- PSoC LCD Segment Drive Expansion Board
- Quick Start Guide
- Kit CD

Inspect the contents of the kit; if you do not find any part, contact your nearest Cypress sales office for help.

1.2 PSoC Creator

Cypress's PSoC Creator software is a state-of-the-art, easy-to-use software development Integrated Development Environment (IDE). It introduces a game-changing, hardware and software co-design environment based on classical schematic entry and revolutionary embedded design methodology.

With PSoC Creator, you can:

- Create and share user defined, custom peripherals using hierarchical schematic design.
- Automatically place and route select components and integrate simple glue logic normally residing in discrete muxes.
- Trade-off hardware and software design considerations allowing you to focus on what matters and get to market faster.

PSoC Creator also enables you to tap into an entire tools ecosystem with integrated compiler tool chains, RTOS solutions, and production programmers to support both PSoC 3 and PSoC 5.

1.3 Getting Started

To get started, refer to Chapter 3 for a description of the kit operation and how to program the PSoC 3 device. An example project is used to explain how to use the PSoC LCD segment drive expansion board with the CY8CKIT-001 DVK. Chapter 4 provides details of the hardware. Chapter 5 guides you to create simple example projects. The Appendix section provides the schematics and BOM associated with the expansion board.

1.4 Additional Learning Resources

Visit www.cypress.com for additional learning resources in the form of data sheets, technical reference manual, and application notes.

1.5 Document History

Release Date	Guide Version	Description of Change
09/02/2009	**	Initial version of the guide
10/13/2009	*A	CDT Updates
11/02/2009	*B	Updated Schematic in Appendix

1.6 Document Conventions

Convention	Usage
Courier New	Displays file locations, user entered text, and source code: C:\ ...cd\licc\
Italics	Displays file names and reference documentation: Read about the <i>sourcefile.hex</i> file in the <i>PSoC Designer User Guide</i> .
[Bracketed, Bold]	Displays keyboard commands in procedures: [Enter] or [Ctrl] [C]
File > Open	Represents menu paths: File > Open > New Project
Bold	Displays commands, menu paths, and icon names in procedures: Click the File icon and then click Open .
Times New Roman	Displays an equation: $2 + 2 = 4$
Text in gray boxes	Describes Cautions or unique functionality of the product.

2. Installation



2.1 CD Installation

Follow these steps to install the CY8CKIT-029 PSoC LCD Segment Drive EBK software:

1. Insert the kit CD into the CD drive of your computer. The CD is designed to auto-run and the PSoC LCD Segment Drive EBK menu appears.

Figure 2-1. CY8CKIT-029 Kit Menu



Note If auto-run does not execute, double click **cyautorun.exe** in the root directory of the CD.

2. Use Windows Explorer to browse documents inside the PSoC LCD Segment Drive EBK folder.

Figure 2-2. Kit CD Folder



Note After the installation is complete, the kit contents are found at the following location:

C:\Program Files\Cypress\PSoC LCD Segment Drive EBK\

2.2 Install Hardware

No hardware installation is required for this kit.

2.3 Install Software

When installing the PSoC LCD segment drive EBK, the installer checks if the prerequisite software is installed in your system. These include PSoC Creator, PSoC Programmer, Windows Installer, .NET, Acrobat Reader, and KEIL Compiler. If these applications are not installed, the installer prompts you to download and install them.

The following software are provided in the CD:

1. PSoC Creator
2. PSoC Programmer 3.10
 - Note** When installing PSoC Programmer, select **Typical** on the Installation Type page.
3. Example Projects (provided in the Firmware folder)

3. Kit Operation



3.1 Introduction

The CY8CKIT-029 PSoC LCD Segment Drive EBK example projects are designed to provide various examples of displays using a display with many segments (8 common lines by 16 segment lines giving 128 addressable segments).

■ Example Project 1: LCD_Seg_Example1_Battery_Meter

This project demonstrates the battery charge indicator along with the 14-segment display of the LCD glass by implementing a battery meter.

■ Example Project 2: LCD_Seg_Example2_StopWatch

This project implements a stopwatch using the RTC component in PSoC Creator. The hours, minutes, and seconds (HH:MM:SS) are displayed on the 14-segment LCD display.

Refer to [Example Projects on page 21](#) for more information.

3.2 Programming PSoC 3 Device

The example projects are provided in the documentation section of the kit CD. This section provides details on programming the PSoC 3 device.

To program the 'Battery Meter' project to the PSoC 3 silicon, follow these steps:

1. Place the PSoC 3 processor module on the CY8CKIT-001 DVK.
2. Power the DVK using either battery connections or a wall power unit.
3. Connect the Minipro3 JTAG cable to the JTAG connector, both on MiniProg3 and the PSoC 3 processor module. Connect the MiniProg3 to a host PC USB high speed port using a USB cable.

The connections for steps 1 to 3 are shown in [Figure 3-1](#).

Figure 3-1. PSoC 3 Processor Module, Power, and Minipro3 Connection with CY8CKIT-001 DVK

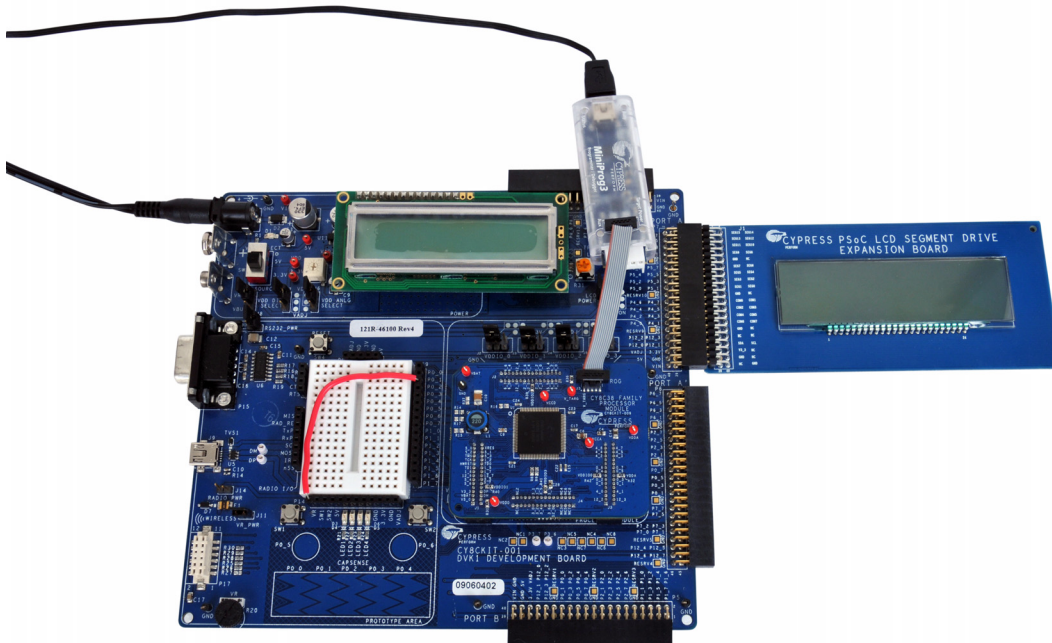

Note Refer to *PSoC Development Kit Board Guide* for details on connecting and programming PSoC devices.

4. Click on the example project, *LCD_Seg_Example1_Battery_Meter* located in **Kits and Solutions** on the startup page of PSoC Creator.

Figure 3-2. Startup Page

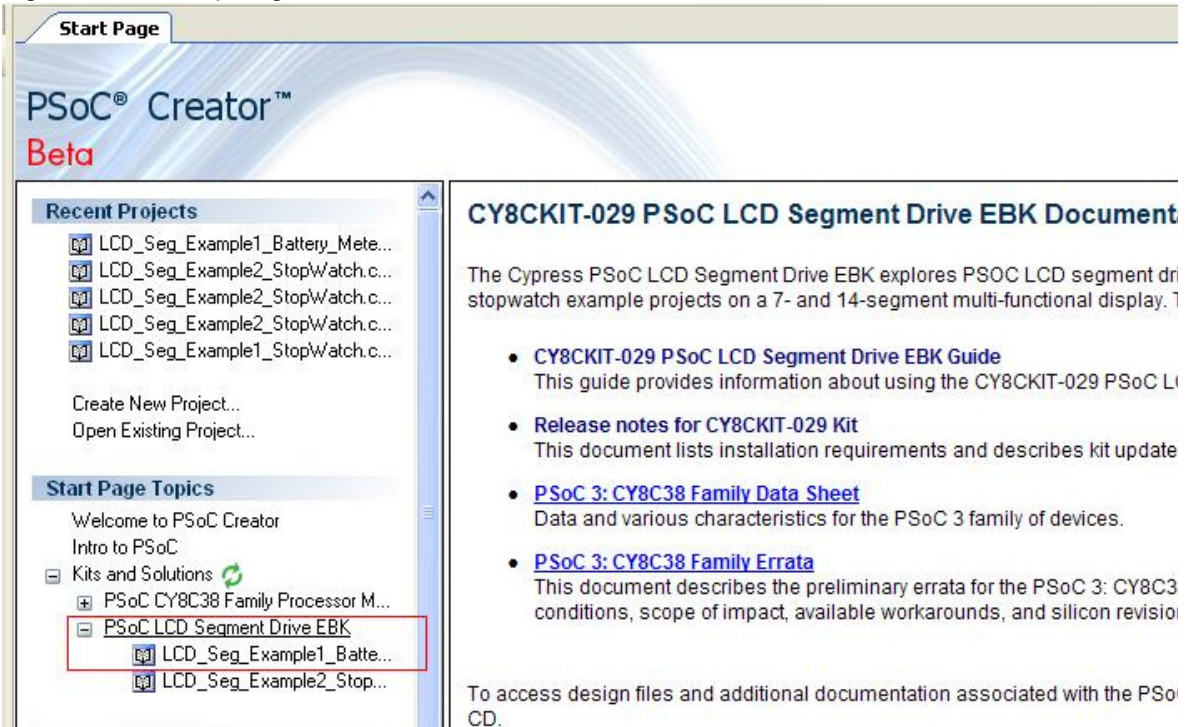

5. Create a folder in the desired location and click **OK**. The project opens in PSoC Creator and is saved in that folder.
6. Build the project by selecting the **Build** option.

Figure 3-3. Build Project

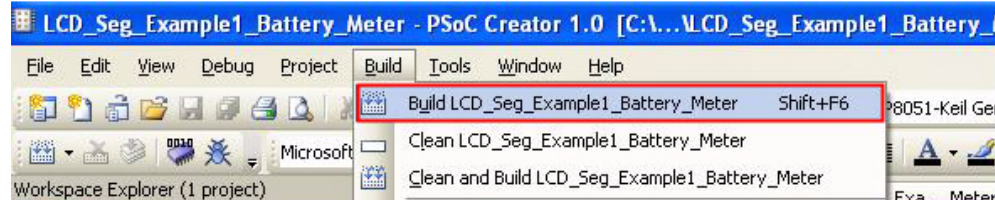

7. Click the **Program** icon.

Figure 3-4. Program Option

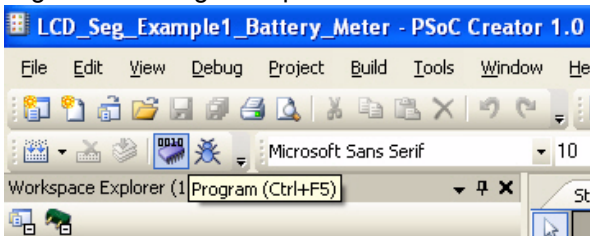

8. The project is programmed successfully as shown in Figure 3-5.

Figure 3-5. Programming Successful

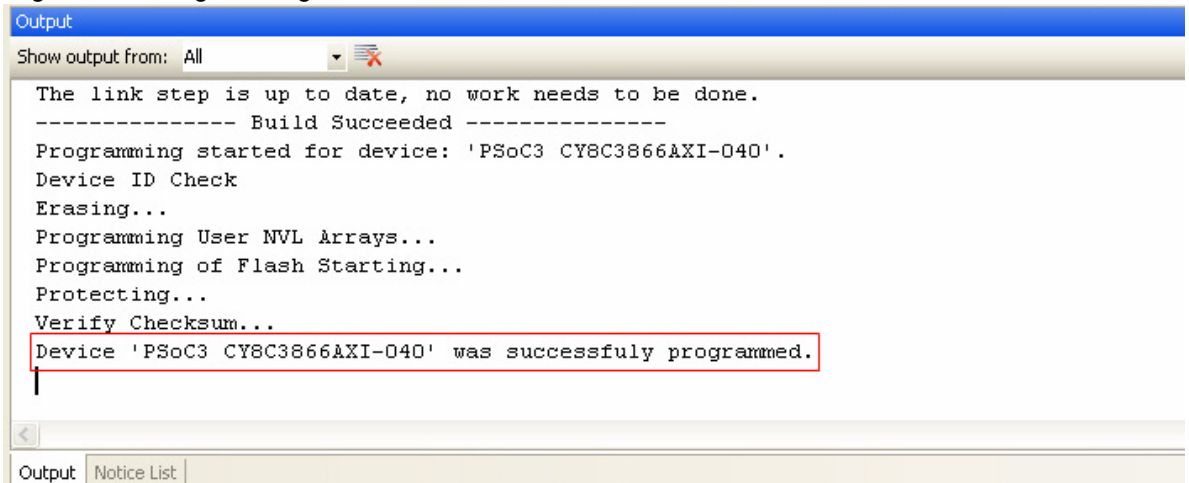

9. Reset the device by pressing the switch SW4 on the DVK. Refer to the following figure.

Figure 3-6. Reset

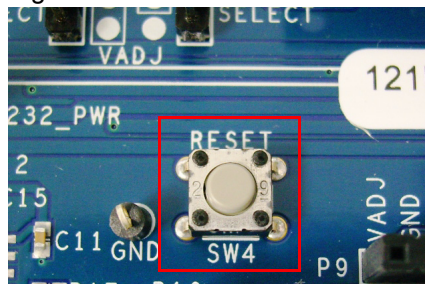

3.3 Hardware Connections

Connect the PSoC LCD segment drive board to port A of CY8CKIT-001 DVK, as shown in [Figure 3-7](#).

Figure 3-7. Board Connected to Port A

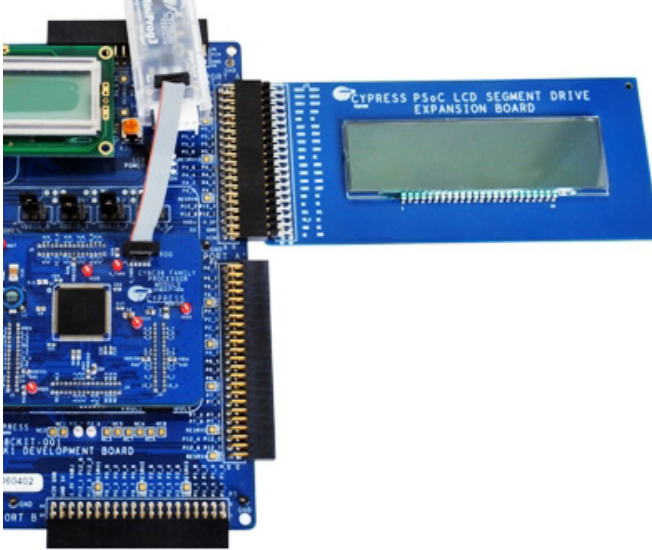

Connect the analog input from the potentiometer (VR slot in CY8CKIT-001 DVK) to the P0_2 on the DVK, as shown in [Figure 3-8](#).

Figure 3-8. VR Connected to P0_2 on CY8CKIT-001 DVK

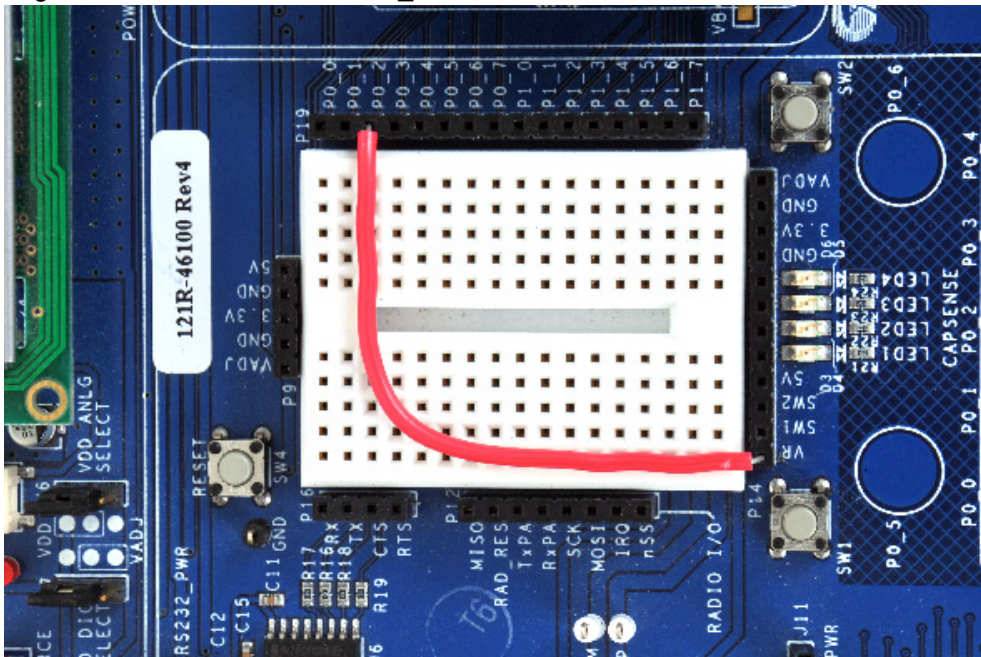

Power the VR by setting the Jumper J11 to ON position.

Figure 3-9. Jumper J11 to ON position on CY8CKIT-001 DVK

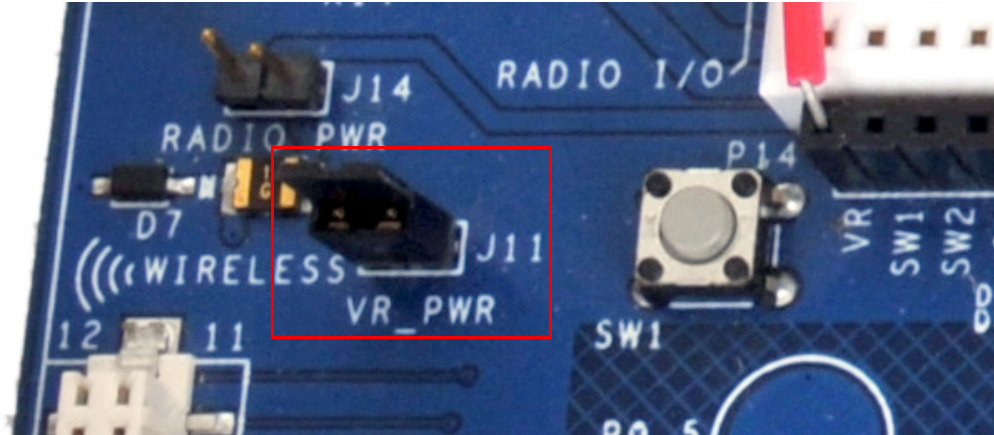

The remaining jumper settings on the DVK are in the default state. Refer to the *PSoC Development Kit Board Guide* for the default setting of jumpers.

3.4 Verify the Output

Vary the VR (Potentiometer) and note the change in status displayed on the LCD.

Figure 3-10. Verifying Output of Battery Meter Project

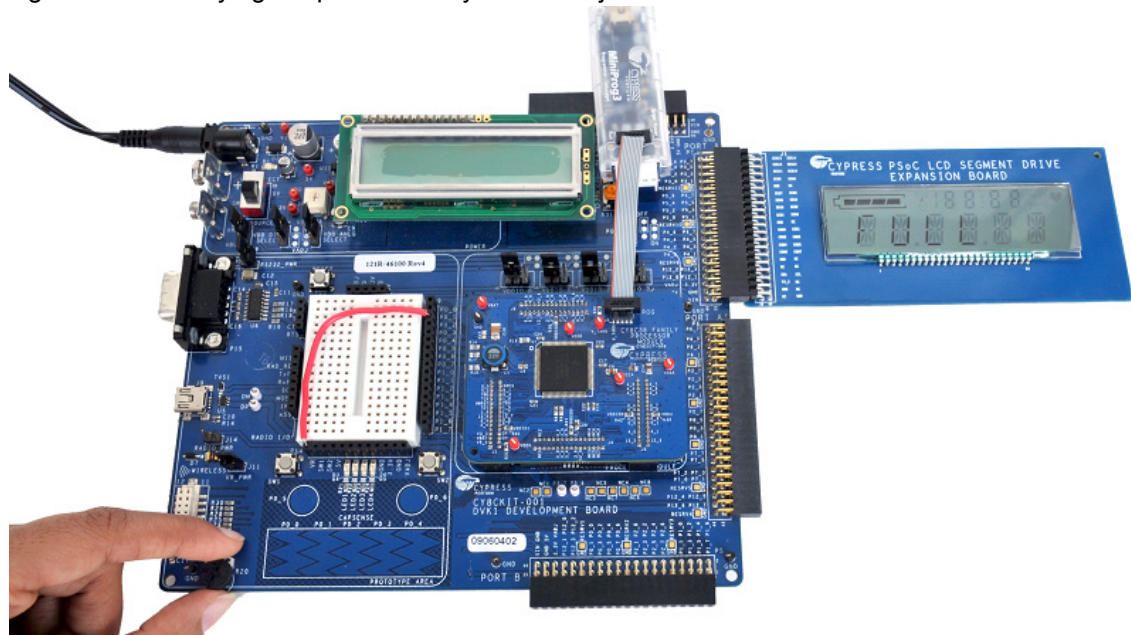

Note The best viewing angle is from 6'O Clock, as per the LCD glass characteristics.

4. Hardware



4.1 System Block Diagram

The PSoC LCD Segment Drive EBK consists of only three blocks.

- LCD Glass (Golden View Display LCD, GV13956A-TPP)
- I2C EEPROM (ST, M24C02-W)
- 40-Pin (20x2) Connector (Sullins Connector Solutions, S2111E-20-ND)

Figure 4-1. System Block Diagram

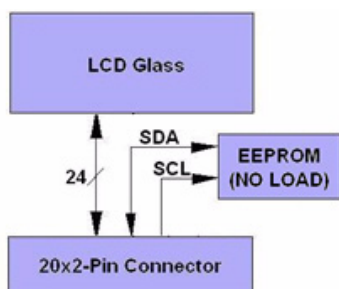

This board incorporates a custom LCD glass with maximum 128 segments. The glass has 24 pins (8 commons and 16 segments lines) that are routed to the 20x2-pin connector and connected to the configured I/O pins of PSoC 3.

I2C EEPROM is a 'No Load' component on the board. It is used to store information about the EBK board number, so PSoC can recognize the board. ST M24C02-W is 2 Kbit EEPROM with operating voltage in the range 2.5V to 5.5V.

40-pin (20x2) connector helps to connect the configured PSoC 3 I/O pins to the LCD glass pins. From the 40 pins available, only 24 are used by the kit. All unused pins are left floating.

4.2 Functional Description

4.2.1 LCD Glass Details

Figure 4-2 shows the image of the LCD glass and Table 4-1 lists the segments details. The LCD glass provides visual feedback.

Figure 4-2. LCD Glass

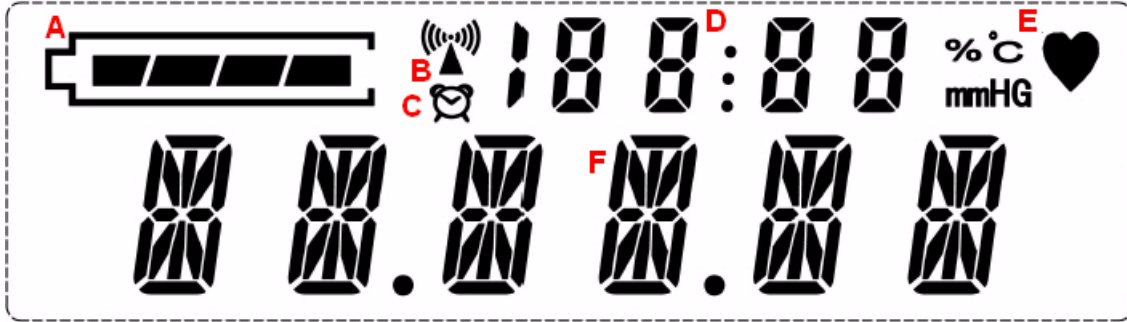

Table 4-1. LCD Glass Segment Details

Label	Description
A	Battery charge indicator bars
B	Wireless symbol
C	Alarm display
D	7 segment numeric section
E	Medical symbol
F	14 segment alpha numeric section

4.2.1.1 Pixel Mapping Table

PIN	1	2	3	4	5	6	7	8	9	10	11	12	13	14	15	16	17	18	19	20	21	22	23	24
COM8	COM8								T7	S1	S2	COL1	S3	S4	S5	COL2	T1	T4	T2	T3	COL3	COL4	T5	T6
COM7		COM7							1A	1J	2A	2J	3A	3J	4A	4J	5A	5J	6A	6J	10D	9D	8D	7D
COM6			COM6						1P	1K	2P	2K	3P	3K	4P	4K	5P	5K	6P	6K	10C	9C	8C	7C
COM5				COM5					1F	1B	2F	2B	3F	3B	4F	4B	5F	5B	6F	6B	10E	9E	8E	7E
COM4					COM4				1G	1L	2G	2L	3G	3L	4G	4L	5G	5L	6G	6L	10G	9G	8G	7G
COM3						COM3			1E	1C	2E	2C	3E	3C	4E	4C	5E	5C	6E	6C	10B	9B	8B	7B
COM2							COM2		1M	1R	2M	2R	3M	3R	4M	4R	5M	5R	6M	6R	10F	9F	8F	7F
COM1								COM1	1N	1D	2N	2D	3N	3D	4N	4D	5N	5D	6N	6D	10A	9A	8A	7A

The following figure shows the segment lettering information for all LCD segments.

Figure 4-3. Segment Lettering Information

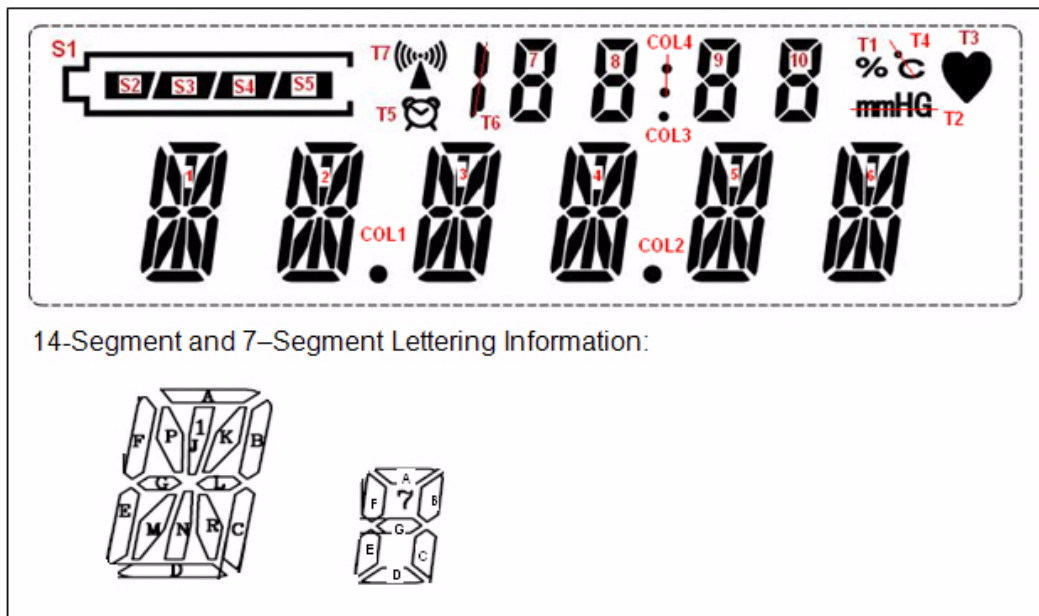

Note Pixel mapping table is also available on the back of the CY8CKIT-029 PSoC LCD Segment Drive EBK.

4.2.1.2 Glass Specification

- Display Type: TN
- Viewing Direction: 6 o'clock
- Drive Method: 1/8 Duty, 1/4 BIAS
- Operating Voltage: 3.0V
- Polarizer Mode: Reflective/Positive
- Operating Temperature: 0°C ~ +50°C.
- Storage Temperature: -10°C ~ +60°C.

4.3 Port Options with CY8CKIT-001 DVK

The LCD segment drive board connects to the CY8CKIT-001 PSoC DVK through the 20x2-pin connector. It hooks up to the DVK through one of the following ports: Port A, Port A Prime, or Port B. [Table 4-2](#) shows the pin assignment for all three ports along with the segment LCD pins (commons and segments lines) assignment. [Figure 3-7](#) shows the connection of LCD segment board with port A of the DVK.

Table 4-2. Port Pin Connections

Pin	Port A	Port A'	Port B	PSoC EBK
1	P3_7	P6_7	P1_7	SEG15
2	P3_6	P6_6	P1_6	SEG14
3	P3_5	P6_5	P1_5	SEG13
4	P3_4	P6_4	P1_4	SEG12
5	P3_3	P6_3	P1_3	SEG11
6	P3_2	P6_2	P1_2	SEG10
7	P3_1	P6_1	P1_1	SEG9
8	P3_0	P6_0	P1_0	SEG8
9	GND	GND	GND	GND
10	RESRV 11	RESRV 8	RESRV 3	NC
11	P5_7	P2_7	P2_7	SEG7
12	P5_6	P2_6	P2_6	SEG6
13	P5_5	P2_5	P2_5	SEG5
14	P5_4	P2_4	P2_4	SEG4
15	P5_3	P2_3	P2_3	SEG3
16	P5_2	P2_2	P2_2	SEG2
17	P5_1	P2_1	P2_1	SEG1
18	P5_0	P2_0	P2_0	SEG0
19	GND	GND	GND	GND
20	RESRV 10	RESRV 7	RESRV 2	NC
21	P4_7	P0_7	P0_7	COM0
22	P4_6	P0_6	P0_6	COM1
23	P4_5	P0_5	P0_5	COM2
24	P4_4	P0_4	P0_4	COM3
25	P4_3	P0_3	P0_3	COM4
26	P4_2	P0_2	P0_2	COM5
27	P4_1	P0_1	P0_1	COM6
28	P4_0	P0_0	P0_0	COM7
29	GND	GND	GND	GND
30	RESRV 9	RESRV 6	RESRV 1	NC
31	P12_3	P7_7	P12_3	NC
32	P12_2	P7_6	P12_2	NC
33	P12_1	P7_5	P12_1	SDA
34	P12_0	P7_4	P12_0	SCL
35	V3_3	P7_3	V3_3	V3_3
36	VADJ	P7_2	VADJ	NC
37	GND	P7_1	GND	GND
38	V5_0	P7_0	V5_0	NC
39	VIN	GND	VIN	NC
40	GND	RESRV 5	GND	GND

Jumper Settings of CY8CKIT-001 DVK for Using Port A' and Port B:

Both port A' and port B uses the Port 2 pins for segment lines. Therefore, switch the jumper J12 to 'Off' position; this switches off the power for the character LCD which is connected to Port 2 of CY8CKIT-001 DVK.

Figure 4-4. J12 Jumper to Off Position

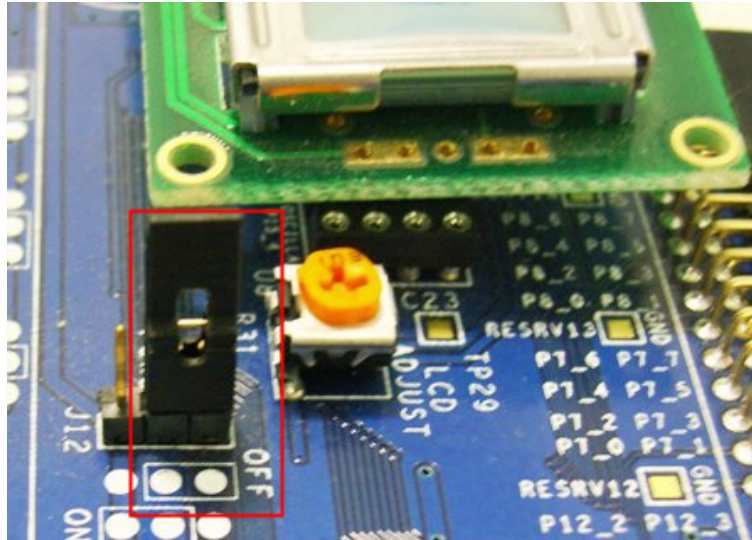

PSoC 3 provides serial wire debugging (SWD) with SWD on GPIO pins option. The port pins used for SWD are P1_0 (SWDIO) and P1_1 (SWDCK). Port B uses the P1_0 and P1_1 for Seg9 and Seg8 signals, respectively. Therefore, debugging option is not available when using Port B. PSoC Creator allows routing P1_1 and P1_0 to be used as GPIO pins when debugging is disabled. To disable debugging, follow these steps:

1. Open the design wide resource file (with extension '.cydwr').
2. Click **System** tab.
3. In the Debugging option, clear the **Enable** check box; select **Debug ports disabled** in the Debug Port Select (DPS) option. Refer to [Figure 4-5](#) for these settings.

Figure 4-5. Disable Debugging

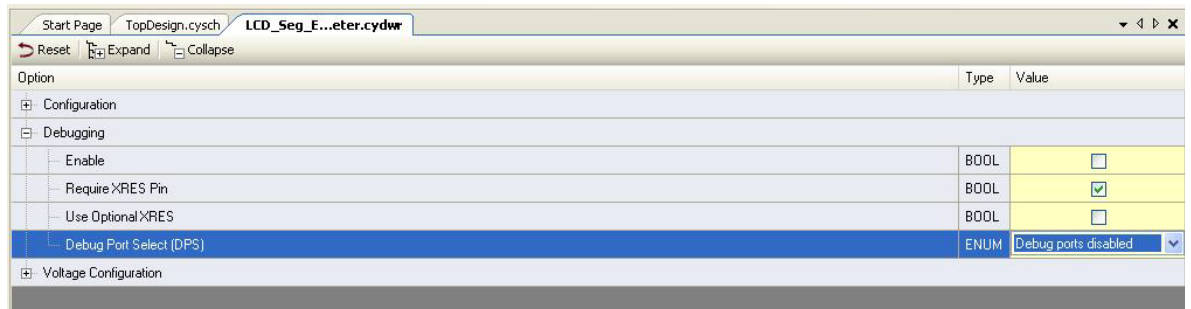

4.4 Power Supply

The kit gets the power from the CY8CKIT-001 DVK through the 40-pin (2X20)connector.

5. Example Projects



5.1 Example Project 1: LCD_Seg_Example1_Battery_Meter

This example project demonstrates the battery charge indicator along with the 14-segment display of the LCD glass by implementing a battery meter. The battery meter is used to graphically display the battery charge level; the 14-segment display is used to relay messages related to the battery charge (full, medium, and low).

5.1.1 Project Description

The potentiometer on the DVK is used to increase and decrease the battery meter on segment LCD. The four segments (S2, S3, S4, S5, refer [Figure 4-3](#)) have four voltage levels (1.25, 2.50, 3.75 and 5V) to define the switching on/off of the battery meter. This is accomplished by the Delta-Sigma ADC count values of PSoC Creator. Based on the battery meter, 'Full', 'Medium', and 'Low' are displayed on the 14-segment LCD display.

Figure 5-1. Battery Meter Firmware Flowchart

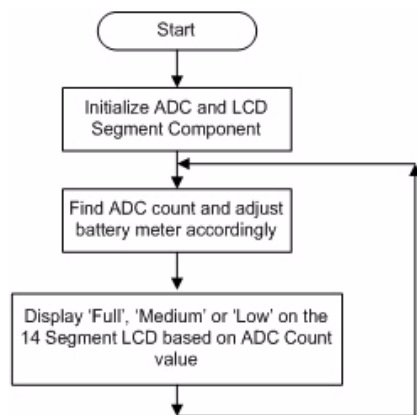

5.1.2 Running the Example Project

Follow the steps described in [Programming PSoC 3 Device on page 9](#) to program the PSoC 3 device with the Batter Meter example project

5.1.3 Hardware Connections

Refer [Hardware Connections on page 12](#) for details on hardware connections.

5.1.4 Verifying Output

Vary the VR (potentiometer) and note the status changes displayed on the LCD.

Figure 5-2. Verification of Battery Meter Project

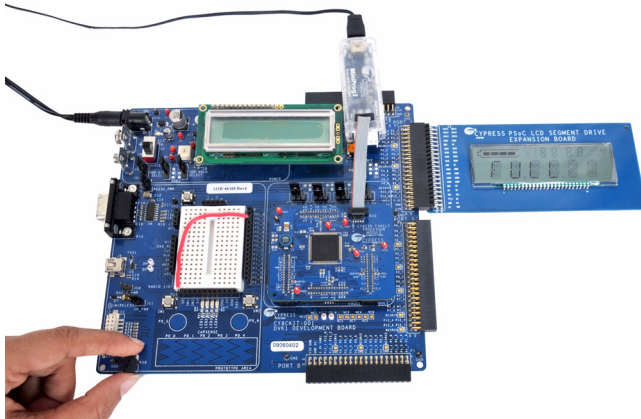

5.1.5 PSoC Creator Project Details

PSoC Creator offers a flexible software tool to create and configure the programmable peripherals.

Figure 5-3. PSoC Creator Top Level Design For Battery Meter Project

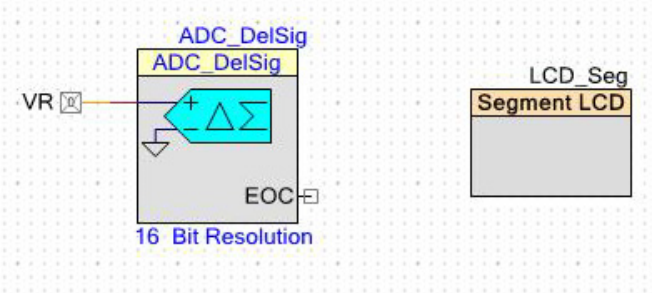

5.1.5.1 LCD_Seg

The LCD_Seg is the core component in this example project. There is a single segment LCD component selected to handle all displays on the LCD glass panel. This component defines all segment assignments for the glass. The component presents a grid containing an entry for each addressable element in the glass. An element can be a pixel in the matrix characters, a segment of one of the segment displays, or a specific icon (symbol) built into the display. Each element is considered a pixel and is individually addressed at its mapped location and turned on or off using the component pixel handling API calls.

There are also helper functions that can be defined. Each helper is specifically designed to allow handling of the different types of characters in the display. Thus, segments of a segment character are grouped and addressed collectively by a single helper. Each helper has a set of component API calls that are placed in the code to write digits or characters to the target display areas.

Each icon is turned on or off using a write pixel API call. The matrix display characters are set using a write string API call. The segment displays are written one character at a time using a write character or write digit API call.

In the basic configuration, the bias voltage is selected to set the contrast level. The contrast level can also be adjusted dynamically, by using the API call provided by the segment LCD component. The higher the bias level set in the call to the API the higher the contrast. The API allows a selection between 0 and 127 with 127 corresponding to the maximum contrast level. The frame rate is selected to be the maximum rate before the characters in the display begin to reduce in contrast.

The segment LCD component in this example project is used to control the switching on/off of the segments of battery charge indicator (S1, S2, S3, S4 and S5) and also 14-segment display message. The component provides all analog and digital signals necessary to drive 128 segments liquid crystal display using eight common lines and sixteen segment drive lines.

Figure 5-4. Segment LCD Configuration: Basic Tab

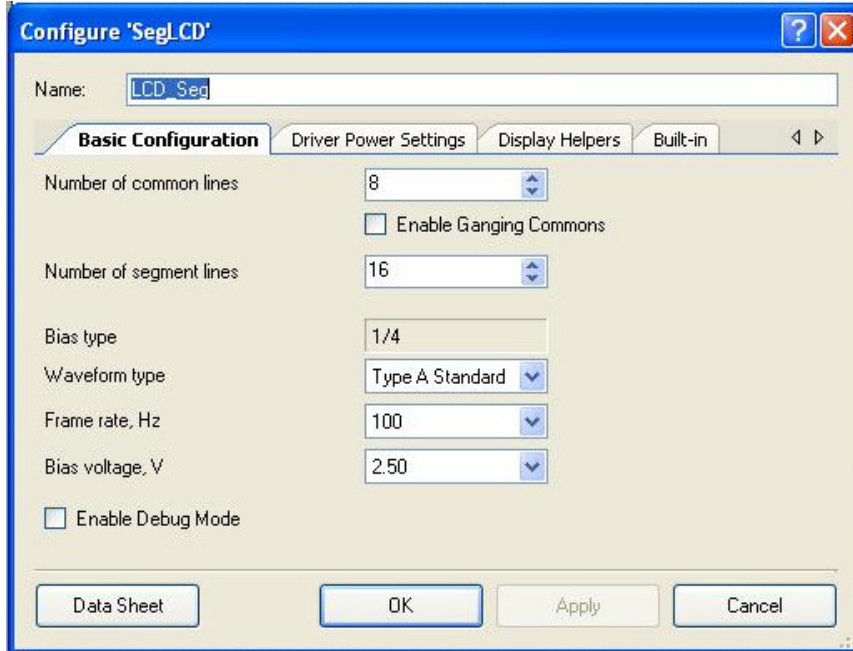

Figure 5-5. Segment LCD Configuration: Driver Power Settings

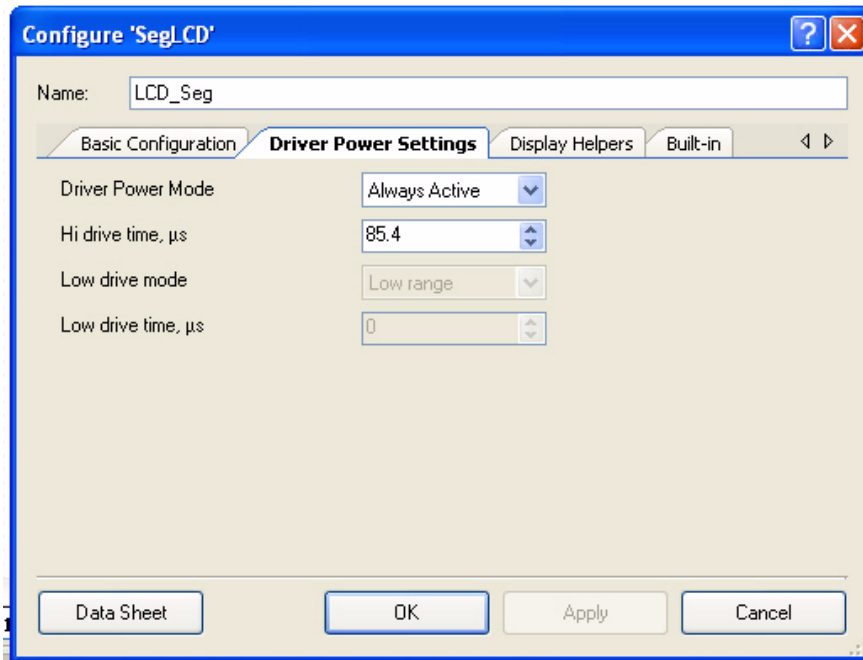

Figure 5-6. Six Character Helper for 16-Segment Display

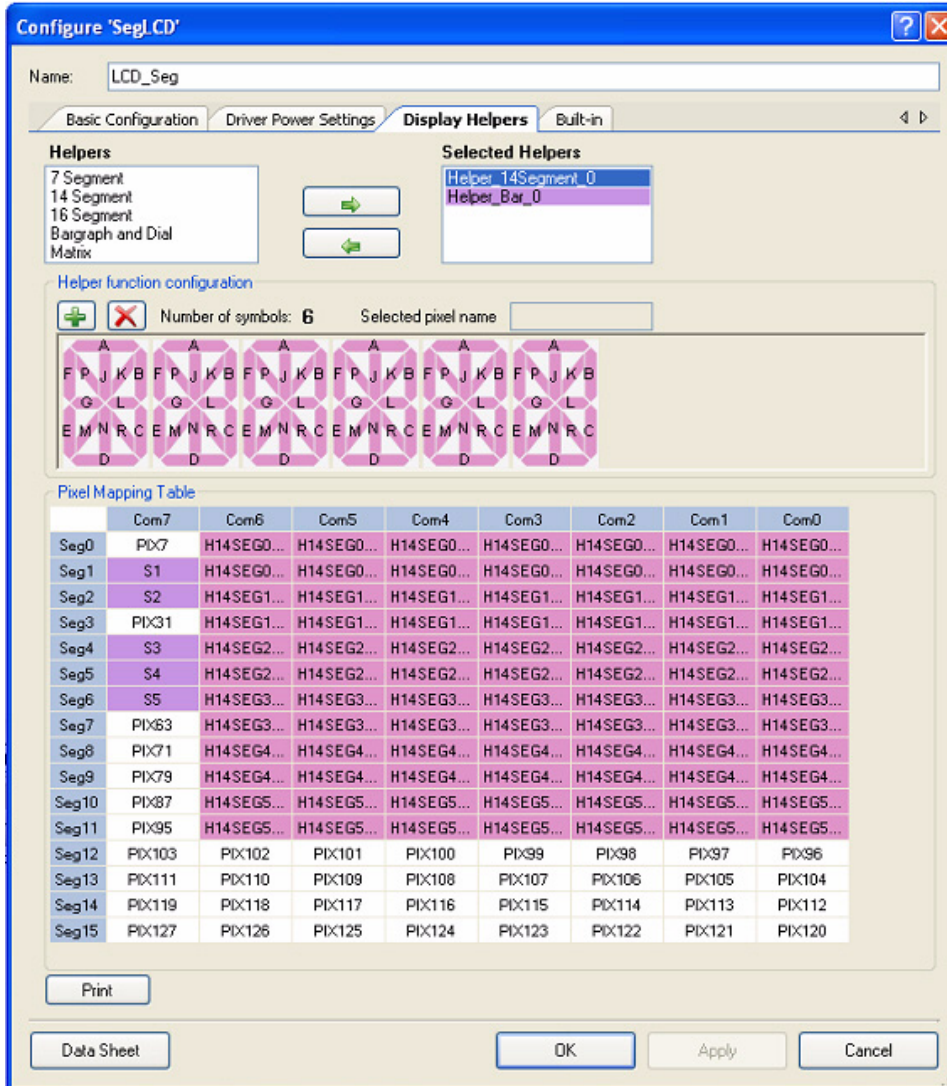
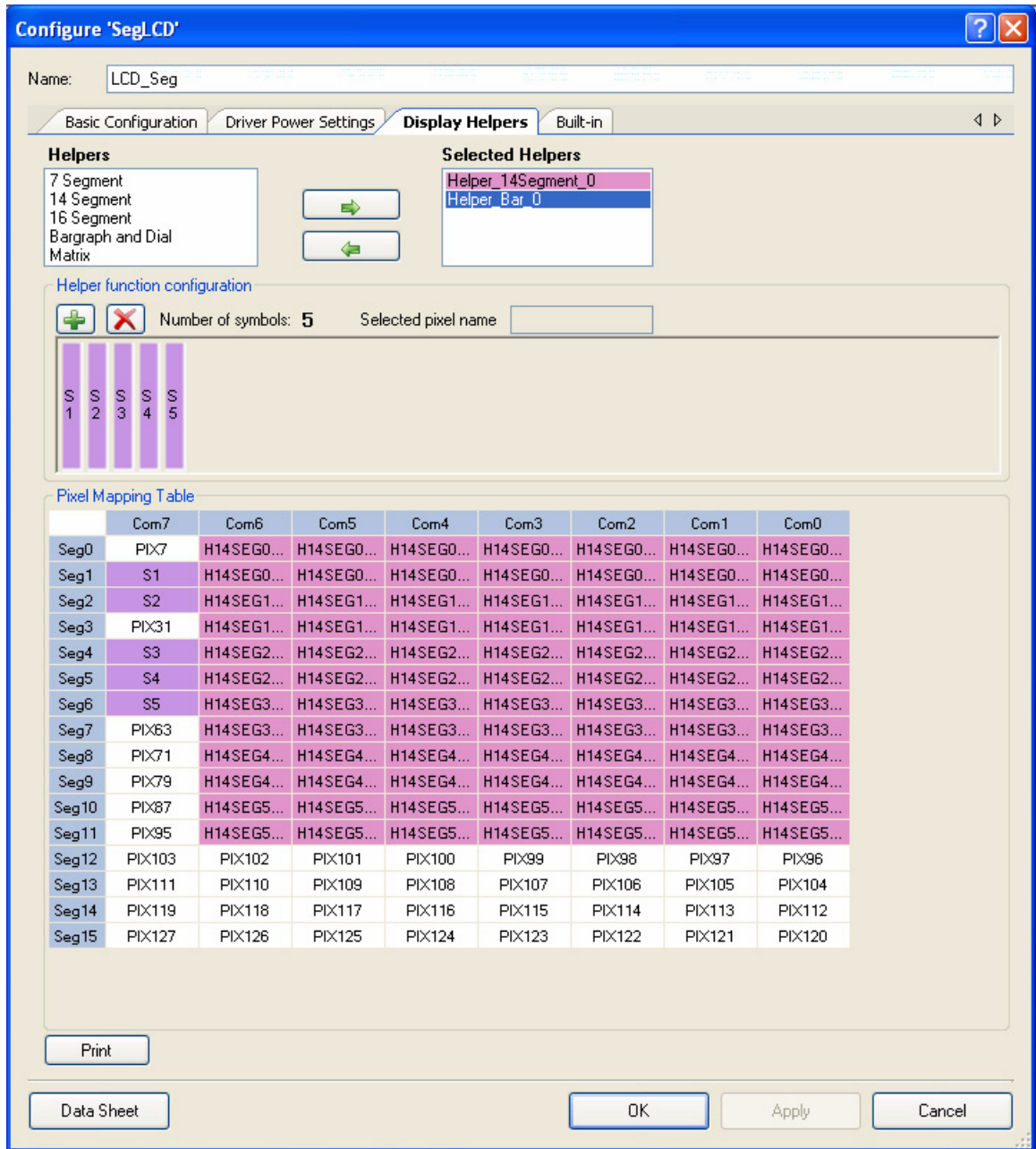

Figure 5-7. Bar Graph Helper for 5 Battery Indicator Segments



Notes

- For details of parameters refer the component data sheets
- The figure only shows the tabs within the component that need to be changed, other tabs such as the Built In tab, have the default setting. This is valid for all components of both example projects.

5.1.5.2 ADC_DeISig

The ADC is used to sample an input voltage, take the voltage from the potentiometer, and control the battery charge indication on the LCD segments.

Figure 5-8. ADC_DeISig Component Configuration: Configure Tab

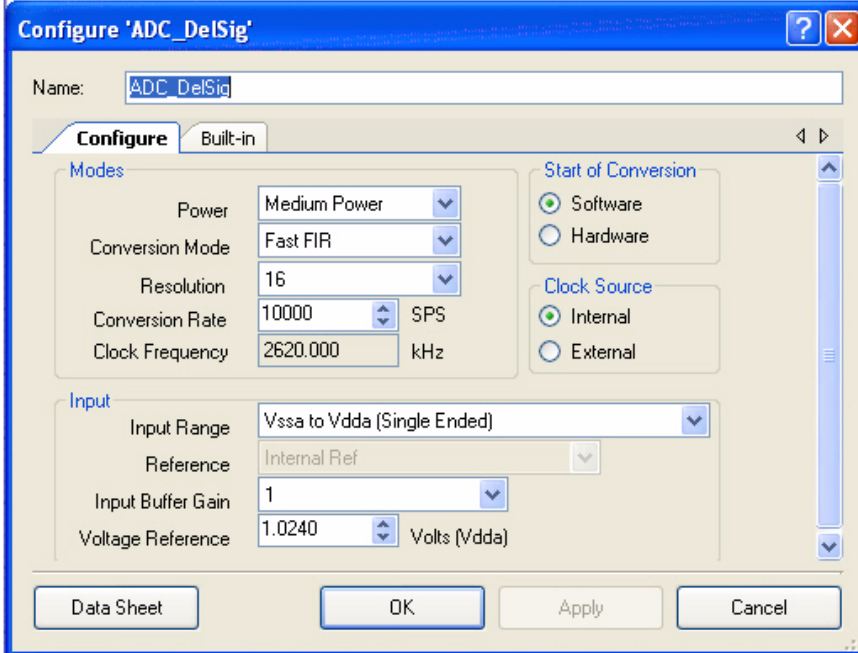

5.1.5.3 VR

The VR pin is used to read the analog value from the potentiometer. The Pin Drive mode is configured as High-Z, which is the default value. Figure 5-9 and Figure 5-10 shows the port pin setting.

Figure 5-9. VR Configuration: Type Tab

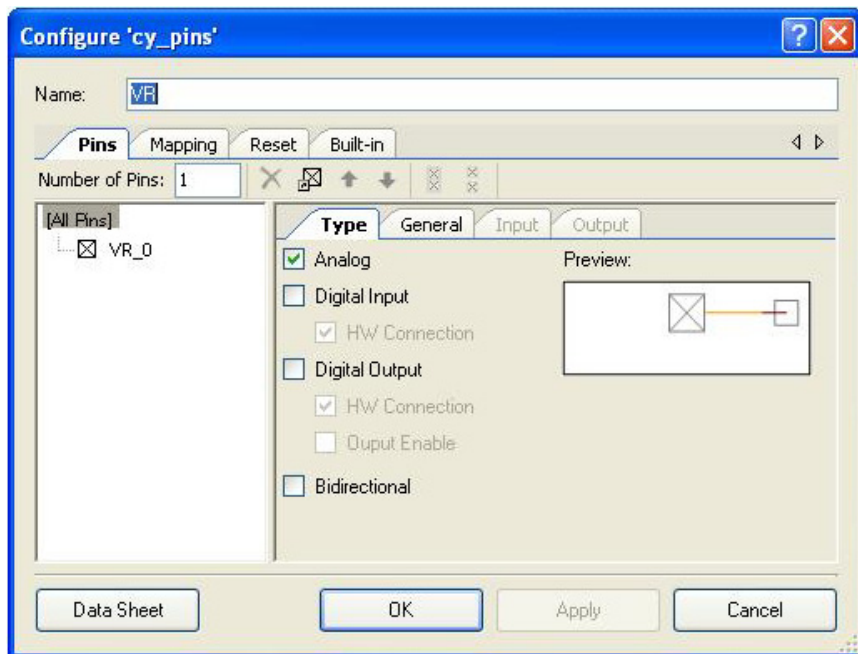
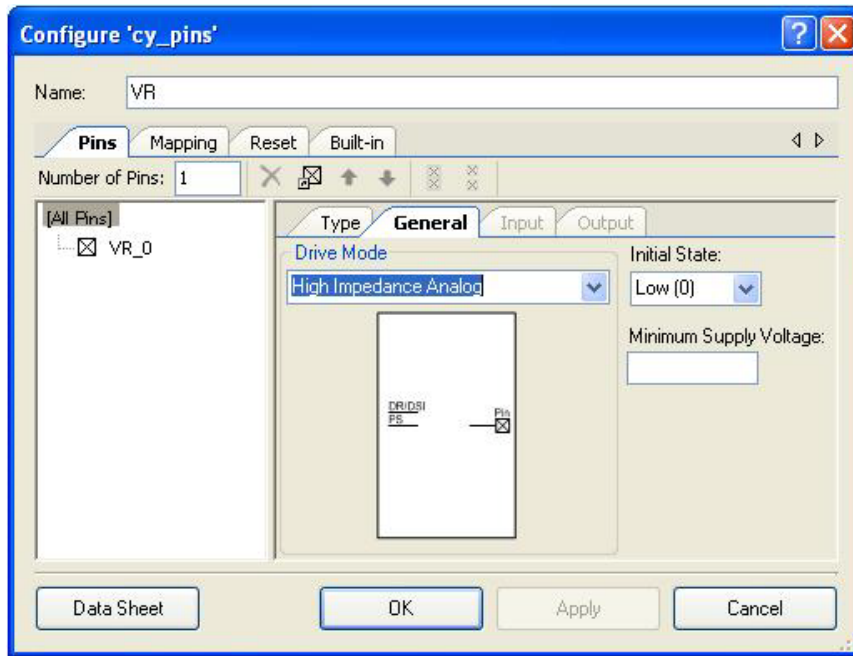

Figure 5-10. VR Configuration: General Tab



5.2 Example Project 2: LCD_Seg_Example2_StopWatch

5.2.1 Project Description

This example project implements a stopwatch using RTC component in PSoC Creator. The values hours, minutes, and seconds (HH:MM:SS) are displayed on the 14 segment display of the LCD.

Figure 5-11. StopWatch Project Flowchart

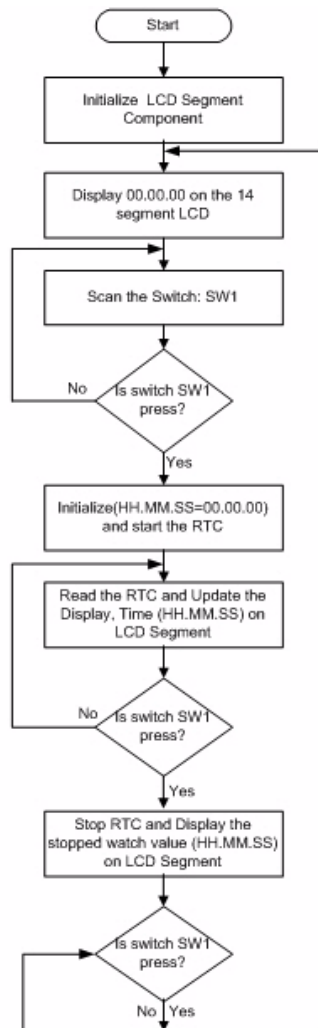

5.2.2 Running the Example Project

To program the PSoC 3 device with the StopWatch example project,

1. Follow steps 1 to 3 described in [Programming PSoC 3 Device on page 9](#).
2. Click the example project, *LCD_Seg_Example2_StopWatch* from Kits and Solutions in the start-up page of PSoC Creator.
3. Follow the steps 5-10 described in [Programming PSoC 3 Device on page 9](#) to complete programming.

5.2.3 Hardware Connections

- Connect the LCD segment drive board to port A of the DVK as shown in [Figure 3-7](#).
- Connect the input from the mechanical switch SW1 of DVK to port pin P0_2 on the DVK as shown in [Figure 5-12](#).

Figure 5-12. Connect Switch SW1 to P0_2 on CY8CKIT-001 DVK

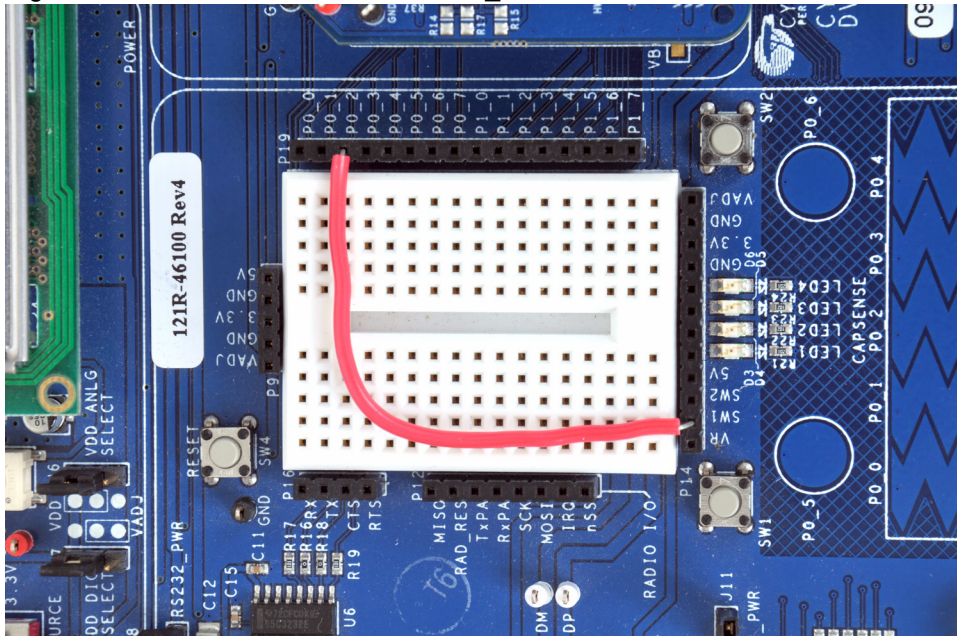

- The remaining jumper settings on the DVK have the default state. Refer to the *PSoC Development Kit Board Guide* for default setting of the jumpers.

5.2.4 Verifying the Output

- On power up, the LCD segment displays HH.MM.SS as 00.00.00 on the 14 segment display of the LCD.

Figure 5-13. LCD Display

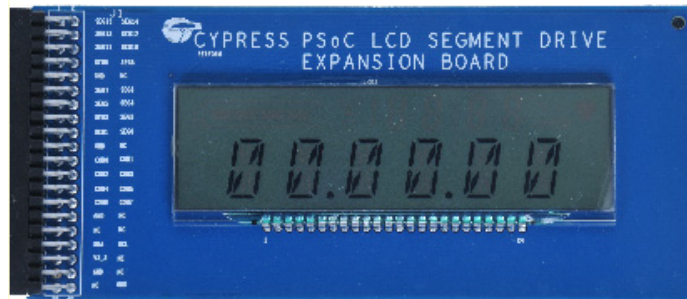

- The mechanical switch SW1 on the DVK is used to start, stop, and reset the stopwatch. The switch sequence is shown [Figure 5-14](#).

Figure 5-14. Switch SW1 Starts RTC

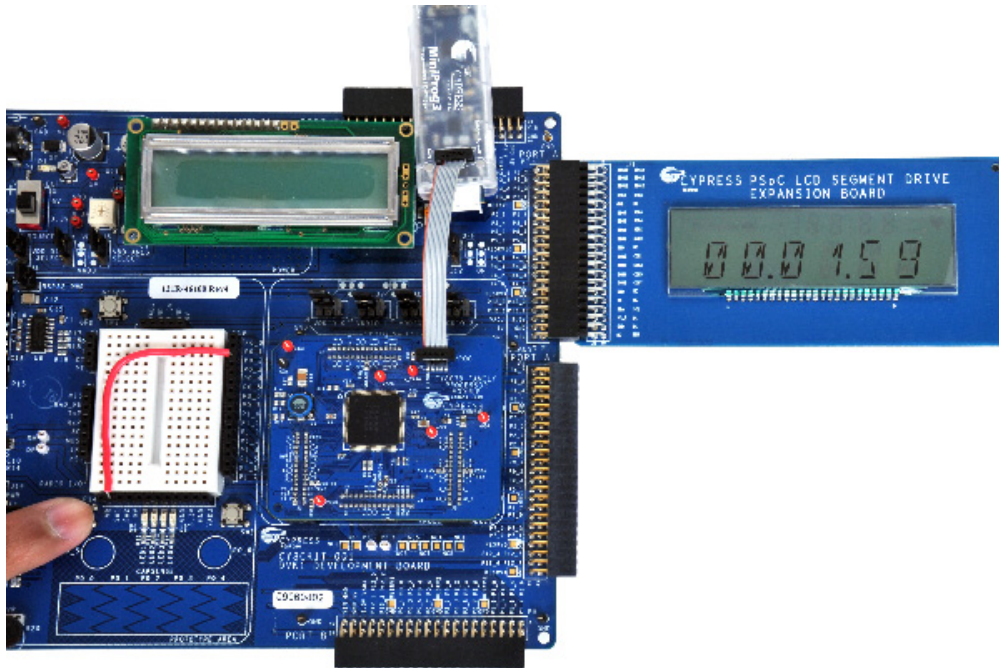

- Pressing SW1 the first time starts the stopwatch and the values HH.MM.SS from the RTC are displayed on the LCD. The stopwatch increments every second. The second press stops the stopwatch and the value at which the watch stopped (HH.MM.SS) is displayed on the LCD. The third press of the switch resets the display to 00.00.00 (HH.MM.SS).

5.2.5 PSoC Creator Project Details

Figure 5-15. PSoC Creator Top Level Design for StopWatch Project

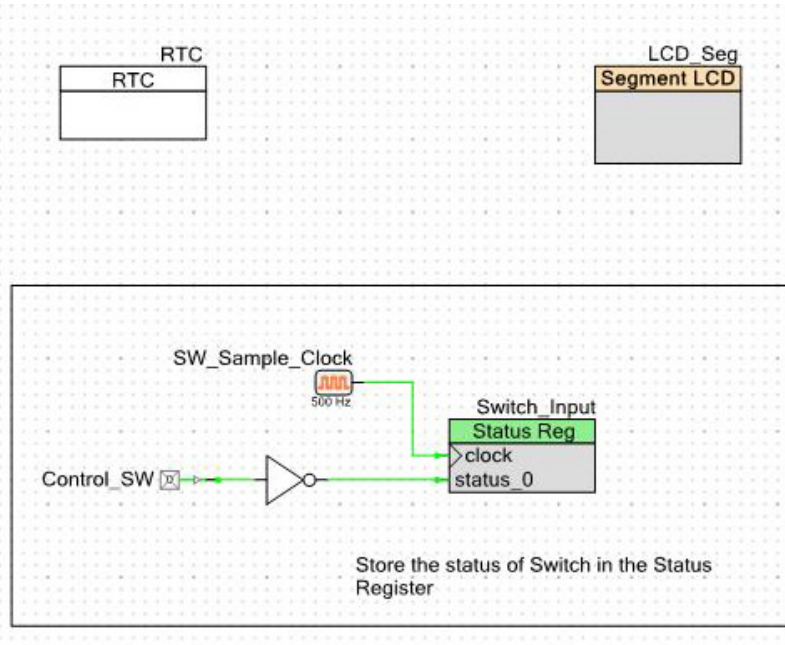

5.2.5.1 LCD_Seg

The LCD_Seg is the core component used in this project. It displays the time (HH:MM:SS) on the 14-segment display section. The component provides all analog and digital signals necessary to drive 128 segments LCD using 8 common lines and 16 segment drive lines.

Figure 5-16. Segment LCD Configuration: Basic Tab

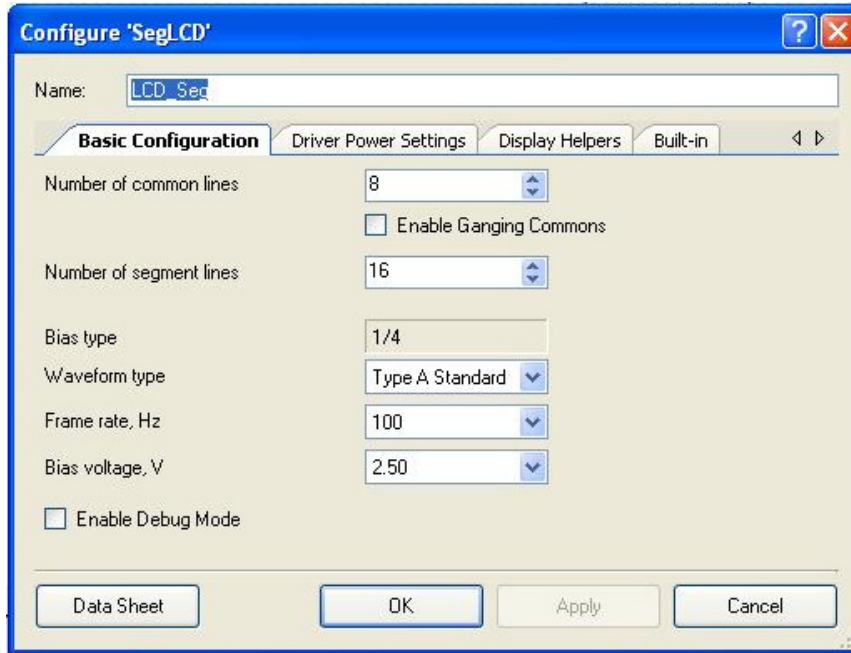

Figure 5-17. Segment LCD Configuration: Driver Power Settings

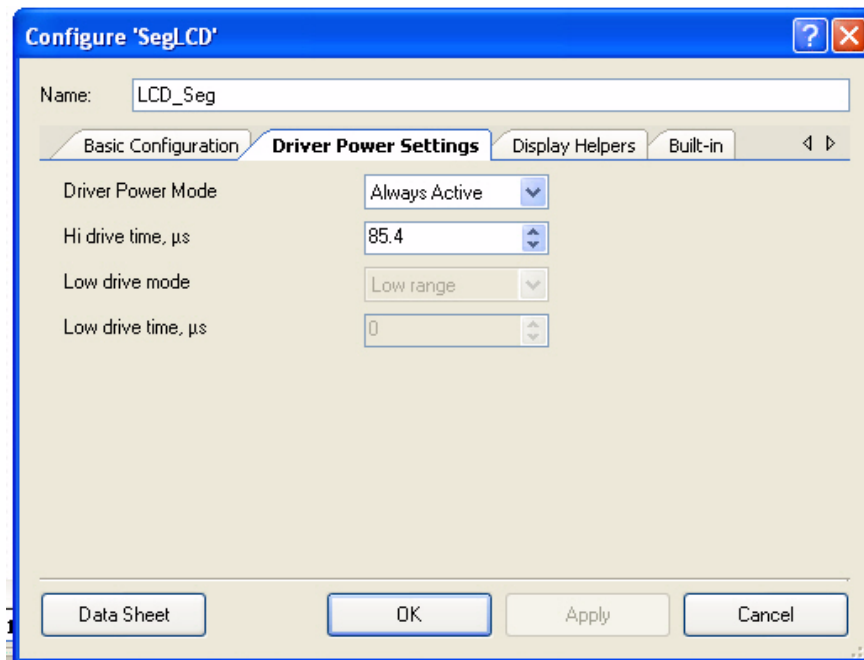

Figure 5-18. Six Character Helper for 16-Segment Display

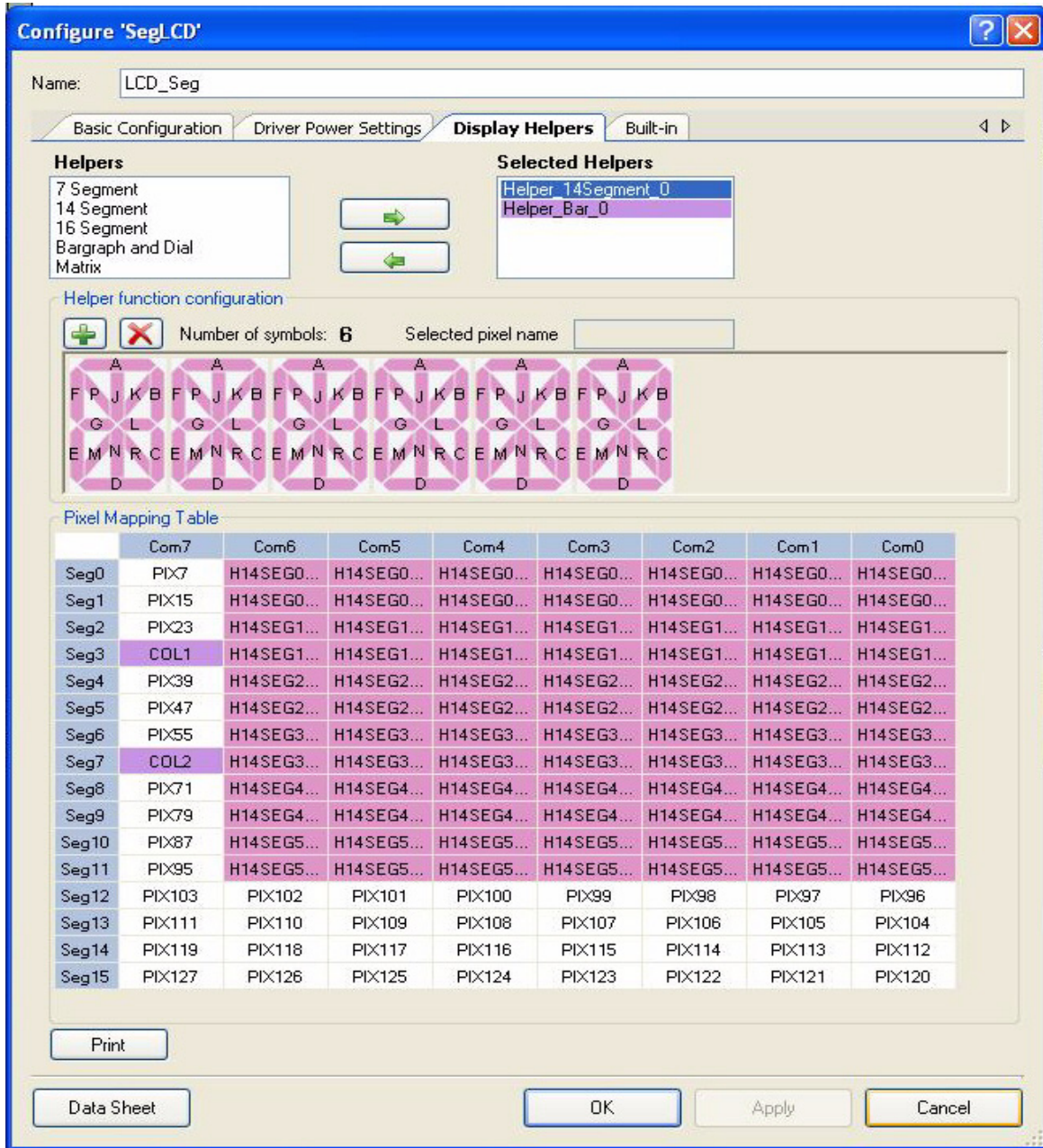
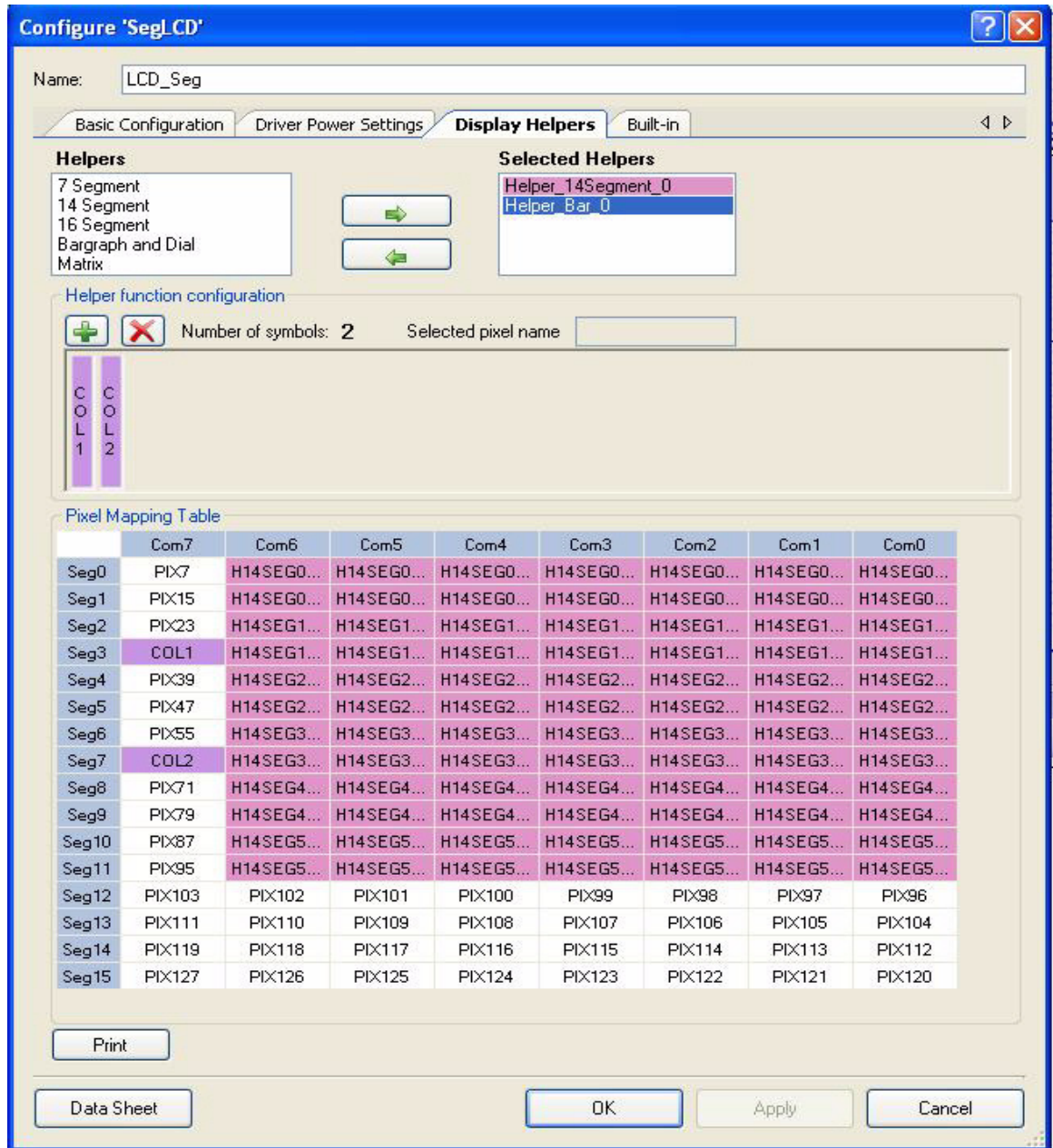

Figure 5-19. Bar Graph Helper for Two Dots between 14-Segment Display Section



5.2.5.2 Real Time Clock (RTC)

The RTC is minimally configured to use Sunday as the start day of the week. The firmware enables the RTC with hours, minutes, and seconds set to zero. If you press the switch SW1, then the RTC starts incrementing the time every second, SS from 0 to 59, then the MM to 0 to 59, and then hours from 0 to 24; thereafter it resets. If the switch SW1 is pressed RTC is stopped and on the third press, the RTC is reset to initial condition of hours, minutes, and hours set to zero.

Figure 5-20. RTC Component Basic Configuration

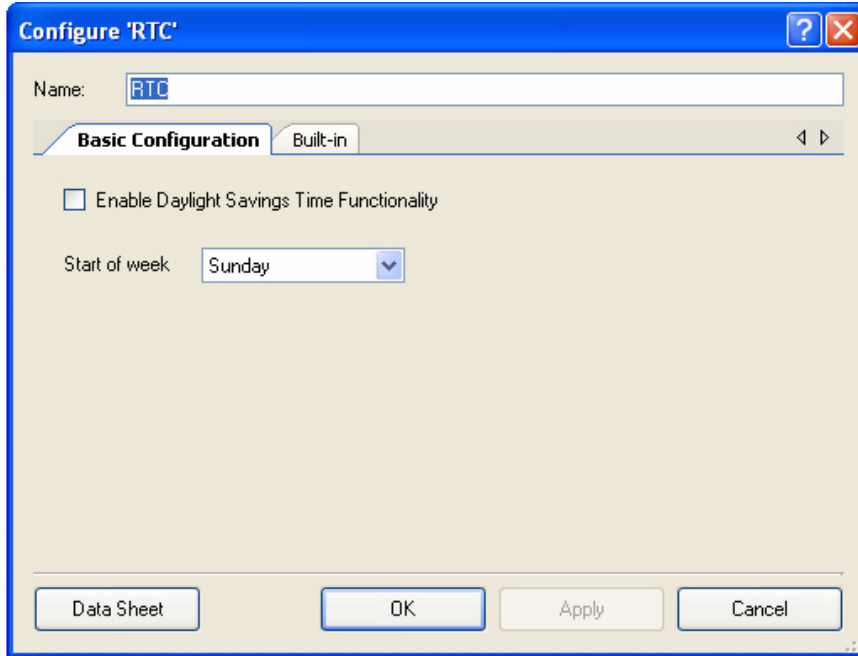

5.2.5.3 Status Register

Status register is used to store the status of the switch which is read in the firmware.

Figure 5-21. Status Register Configuration: Basic Tab

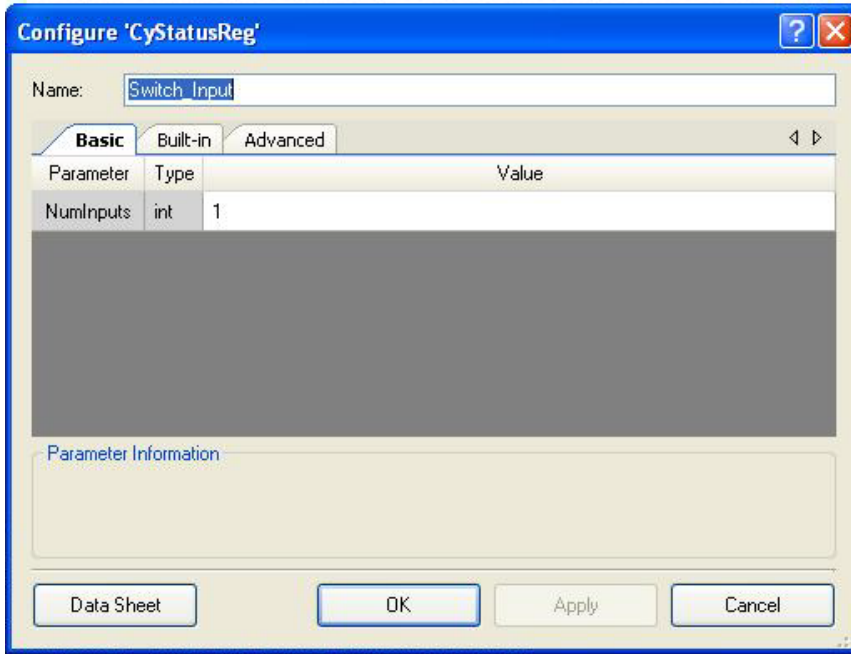

5.2.5.4 Sw_Sample_Clock

The clock component of PSoC Creator is used to sample the switch at the frequency of 500 Hz.

Figure 5-22. Clock Component Configuration: Configure Clock Tab

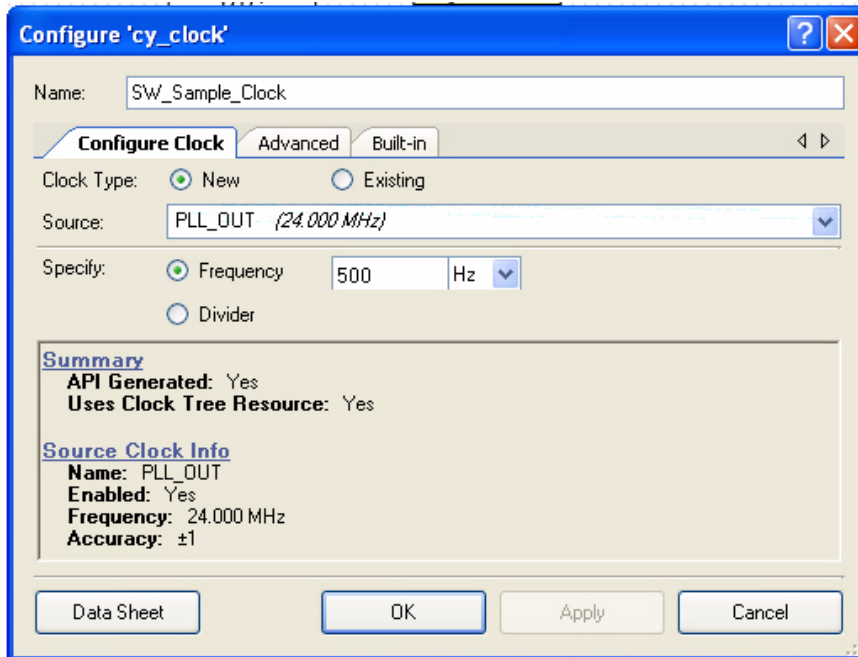

5.2.5.5 Clock_SW

This is a digital port component used to read the pin status. It is configured as "Input" port.

Figure 5-23. Switch Pin Configuration: Basic Tab

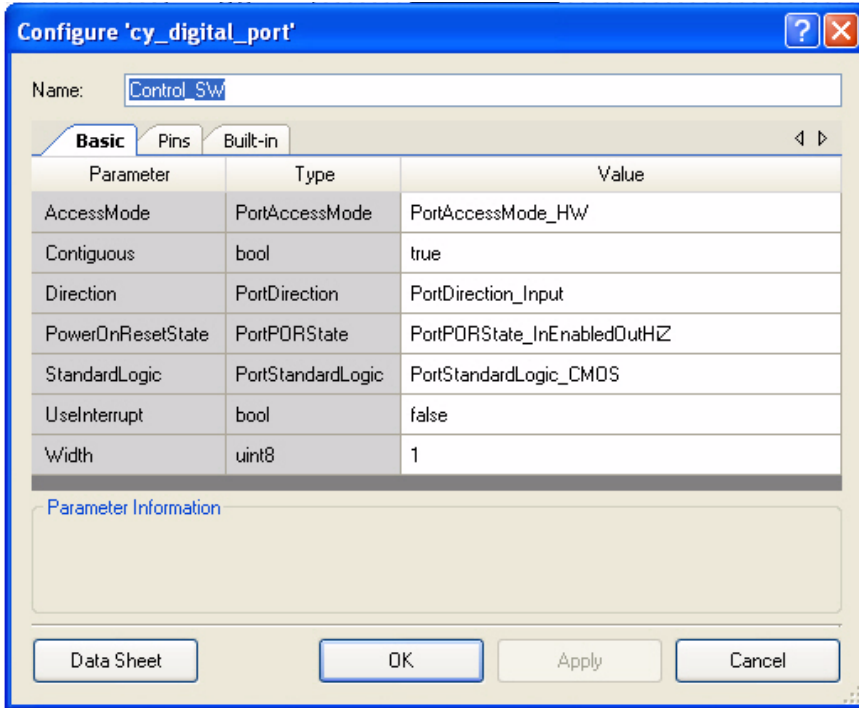
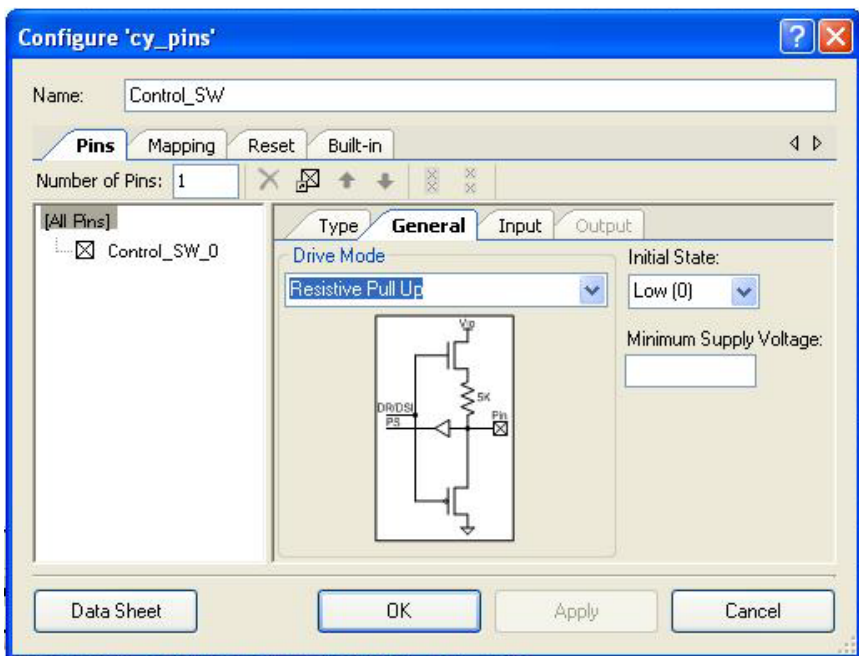

Figure 5-24. Switch Pin Configuration: General Tab



Note Pin assignment in both example projects is according to Port A of the DVK. Open the example project and change the pin assignment in PSoC Creator (in .cydwr file) for Port A' or port B according to [Table 4-2](#). The pin assignment for example project 1 is shown in [Figure 5-25](#).

Figure 5-25. Pin Connection Mapping for Port A'

Alias	Name	Pin	Lock	Type
VR	VR	P1[7]	<input checked="" type="checkbox"/>	Analog
	LCD_Seg_Com[7]	P0[0]	<input checked="" type="checkbox"/>	Digital Output
	LCD_Seg_Com[6]	P0[1]	<input checked="" type="checkbox"/>	Digital Output
	LCD_Seg_Com[5]	P0[2]	<input checked="" type="checkbox"/>	Digital Output
	LCD_Seg_Com[4]	P0[3]	<input checked="" type="checkbox"/>	Digital Output
	LCD_Seg_Com[3]	P0[4]	<input checked="" type="checkbox"/>	Digital Output
	LCD_Seg_Com[2]	P0[5]	<input checked="" type="checkbox"/>	Digital Output
	LCD_Seg_Com[1]	P0[6]	<input checked="" type="checkbox"/>	Digital Output
	LCD_Seg_Com[0]	P0[7]	<input checked="" type="checkbox"/>	Digital Output
	LCD_Seg_Seg[15]	P6[7]	<input checked="" type="checkbox"/>	Digital Output
	LCD_Seg_Seg[14]	P6[6]	<input checked="" type="checkbox"/>	Digital Output
	LCD_Seg_Seg[13]	P6[5]	<input checked="" type="checkbox"/>	Digital Output
	LCD_Seg_Seg[12]	P6[4]	<input checked="" type="checkbox"/>	Digital Output
	LCD_Seg_Seg[11]	P6[3]	<input checked="" type="checkbox"/>	Digital Output
	LCD_Seg_Seg[10]	P6[2]	<input checked="" type="checkbox"/>	Digital Output
	LCD_Seg_Seg[9]	P6[1]	<input checked="" type="checkbox"/>	Digital Output
	LCD_Seg_Seg[8]	P6[0]	<input checked="" type="checkbox"/>	Digital Output
	LCD_Seg_Seg[7]	P2[7]	<input checked="" type="checkbox"/>	Digital Output
	LCD_Seg_Seg[6]	P2[6]	<input checked="" type="checkbox"/>	Digital Output
	LCD_Seg_Seg[5]	P2[5]	<input checked="" type="checkbox"/>	Digital Output
	LCD_Seg_Seg[4]	P2[4]	<input checked="" type="checkbox"/>	Digital Output
	LCD_Seg_Seg[3]	P2[3]	<input checked="" type="checkbox"/>	Digital Output
	LCD_Seg_Seg[2]	P2[2]	<input checked="" type="checkbox"/>	Digital Output
	LCD_Seg_Seg[1]	P2[1]	<input checked="" type="checkbox"/>	Digital Output
	LCD_Seg_Seg[0]	P2[0]	<input checked="" type="checkbox"/>	Digital Output

Note The pins for VR and the SW1 must be reassigned to any other free GPIO when using port A' and port B. This is because P0_2 pin used in both example projects for VR and SW1, is used for common lines. In addition, for the StopWatch example project, the port pin used for the switch SW1 has resistive pull up drive mode. This is because the switch SW1 is connected to the switch in the CY8CKIT-001 DVK. The switch in the DVK is connected to GND when pressed; therefore, the drive mode must be set to 'Resistive Pull Up'. Write '1' to the port pin in the firmware to make it work. The following code indicates the location where you can set this according to the selection of port pin.

```

/* Write '1' to input switch port pin, P0.2 for enable resistive pull up
*/
CY_SET_REG8 (CYDEV_IO_PRT_PRT0_DR, 0x04);

To use P1_7, modify as shown here:
/* Write '1' to input switch port pin, P1.7 for enable resistive pull up
*/
CY_SET_REG8 (CYDEV_IO_PRT_PRT1_DR, 0x80);

```

A. Appendix



A.1 Schematic

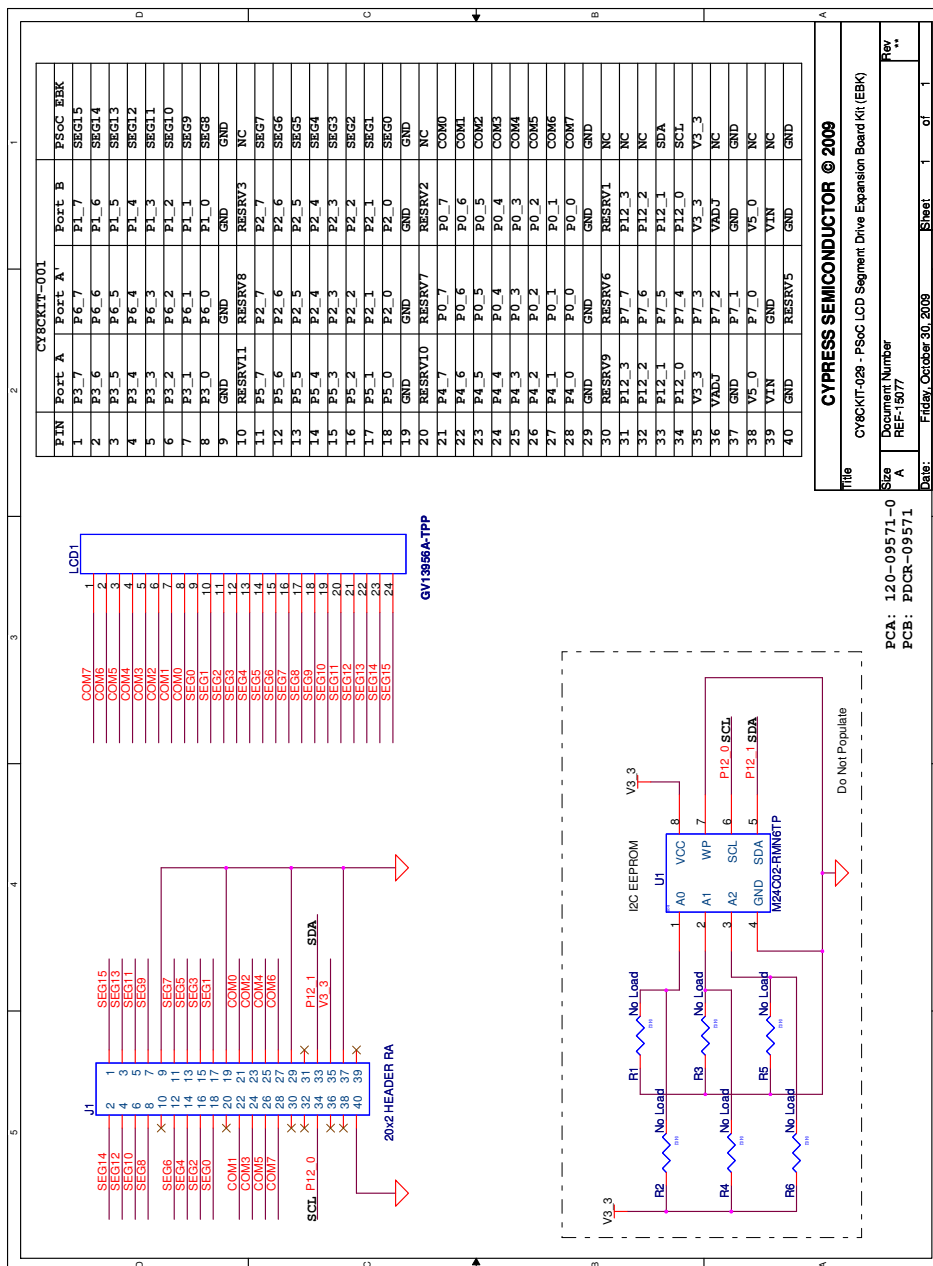

A.2 Board Layout

A.2.1 PDCR-09571 Top View

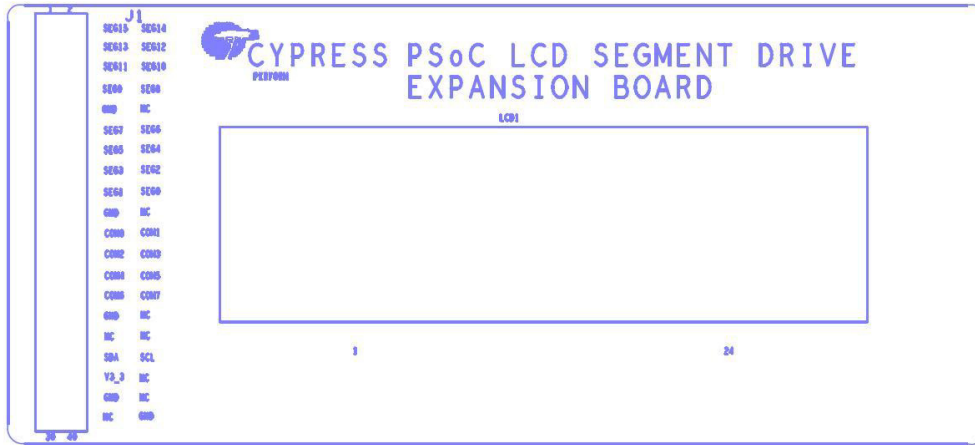

PDCR-09571 REV ** PRIMARY SILKSCREEN

A.2.2 PDCR-09571 Bottom View

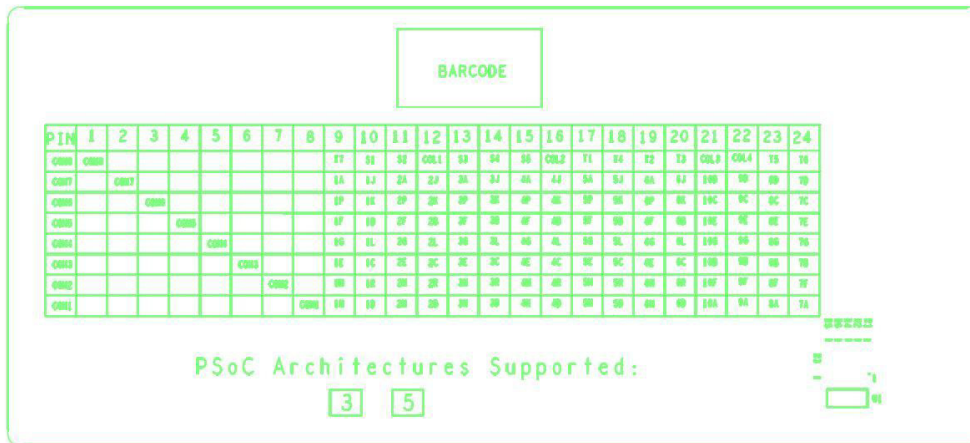

PDCR-09571 REV ** SECONDARY SILKSCREEN

A.3 BOM

Item	Qty.	Reference	Description	Manufacturer Name	Manufacturing Part Number
1			PCB	Cypress	PDCR-09571 REV**
2	1	LCD1	LCD Glass	Golden View Display	GV13956A-TPP
3	1	J1	CONN HEADER.100 DUAL R/A 40POS	Sullins Connector Solutions	S2111E-20-ND
No Load					
4	6	R1, R2, R3, R4, R5, R6	RES 10 K Ω 1/16W 5% 0402 SMD	Panasonic - ECG	ERJ-2GEJ103X
5	1	U1	IC SRL EEPROM I2C 2 KBIT SO-8	STMicroelectronics	M24C02-RMN6TP
Install at the bottom of PCB as close to the corners as possible					
6	4	N/A	BUMPER WHITE.500X.23 SQUARE	Richco Plastic Co	RBS-3R

