

## Power SMD LED PLCC-4

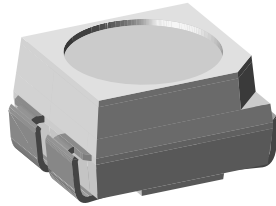

19210

### DESCRIPTION

The VLMK32.., VLMY32.. is an advanced development in terms of heat dissipation.

The leadframe profile of this PLCC-4 SMD package is optimized to reduce the thermal resistance.

This allows higher drive current and doubles the light output compared to Vishay's high intensity SMD LED in PLCC-2 package.

### PRODUCT GROUP AND PACKAGE DATA

- Product group: LED
- Package: SMD PLCC-4
- Product series: power
- Angle of half intensity:  $\pm 60^\circ$

### FEATURES

- Available in 8 mm tape
- High brightness SMD LED
- Luminous intensity and color categorized per packing unit
- Luminous intensity ratio per packing unit  $I_{Vmax}/I_{Vmin} \leq 1.6$
- ESD-withstand voltage: up to 2 kV according to JESD22-A114-B
- Suitable for all soldering methods according to CECC 00802 and J-STD-020C
- Preconditioning: acc. to JEDEC level 2a
- Qualified according to JEDEC moisture sensitivity level 2a
- Automotive qualified: AEC-Q101
- Lead (Pb)-free device
- Component in accordance to RoHS 2002/95/EC and WEEE 2002/96/EC
- Compatible with IR reflow solder processes according to CECC 00802 and J-STD-020C

**RoHS**  
COMPLIANT

### APPLICATIONS

- Interior and exterior lighting
- Indicator and backlighting purposes for audio, video, LCDs, switches, symbols, illuminated advertising etc.
- Illumination purpose, alternative to incandescent lamps
- General use

### PARTS TABLE

PART	COLOR, LUMINOUS INTENSITY	TECHNOLOGY
VLMK32ABBB-GS08	Amber, $I_V = (1400 \text{ to } 2850) \text{ mcd}$	AllnGaP on Si
VLMY32ABBB-GS08	Yellow, $I_V = (1400 \text{ to } 2850) \text{ mcd}$	AllnGaP on Si

### ABSOLUTE MAXIMUM RATINGS <sup>1)</sup> VLMK32.., VLMY32..

PARAMETER	TEST CONDITION	SYMBOL	VALUE	UNIT
Reverse voltage <sup>2)</sup>		$V_R$	5	V
Forward current		$I_F$	70	mA
Power dissipation		$P_{tot}$	200	mW
Junction temperature		$T_j$	125	°C
Operating temperature range		$T_{amb}$	- 40 to + 100	°C
Storage temperature range		$T_{stg}$	- 40 to + 100	°C
Thermal resistance junction/ambient	mounted on PC board FR4	$R_{thJA}$	290	K/W

Note:

<sup>1)</sup>  $T_{amb} = 25^\circ\text{C}$ , unless otherwise specified

<sup>2)</sup> Driving the LED in reverse direction is suitable for short term application



OPTICAL AND ELECTRICAL CHARACTERISTICS <sup>1)</sup> VLMK32., AMBER							
PARAMETER	TEST CONDITION	PART	SYMBOL	MIN.	TYP.	MAX.	UNIT
Luminous intensity <sup>2)</sup>	I <sub>F</sub> = 50 mA	VLMK32ABBB	I <sub>V</sub>	1400		2850	mcd
Dominant wavelength	I <sub>F</sub> = 50 mA		λ <sub>d</sub>	610		621	nm
Spectral bandwidth at 50 % I <sub>rel max.</sub>	I <sub>F</sub> = 50 mA		Δλ		18		nm
Angle of half intensity	I <sub>F</sub> = 50 mA		φ		± 60		deg
Forward voltage <sup>3)</sup>	I <sub>F</sub> = 50 mA		V <sub>F</sub>	1.85		3.03	V
Reverse current	V <sub>R</sub> = 5 V		I <sub>R</sub>		0.01	10	μA

Note:

<sup>1)</sup> T<sub>amb</sub> = 25 °C, unless otherwise specified

<sup>2)</sup> In one packing unit I<sub>Vmax.</sub>/I<sub>Vmin.</sub> ≤ 1.6

<sup>3)</sup> Forward voltages are tested at a current pulse duration of 1 ms and a tolerance of ± 0.1 V

OPTICAL AND ELECTRICAL CHARACTERISTICS <sup>1)</sup> VLMY32., YELLOW							
PARAMETER	TEST CONDITION	PART	SYMBOL	MIN.	TYP.	MAX.	UNIT
Luminous intensity <sup>2)</sup>	I <sub>F</sub> = 50 mA	VLMY32ABBB	I <sub>V</sub>	1400		2850	mcd
Dominant wavelength	I <sub>F</sub> = 50 mA		λ <sub>d</sub>	585	588	594	nm
Spectral bandwidth at 50 % I <sub>rel max.</sub>	I <sub>F</sub> = 50 mA		Δλ		18		nm
Angle of half intensity	I <sub>F</sub> = 50 mA		φ		± 60		deg
Forward voltage <sup>3)</sup>	I <sub>F</sub> = 50 mA		V <sub>F</sub>	1.85		3.03	V
Reverse current	V <sub>R</sub> = 5 V		I <sub>R</sub>		0.01	10	μA

Note:

<sup>1)</sup> T<sub>amb</sub> = 25 °C, unless otherwise specified

<sup>2)</sup> In one packing unit I<sub>Vmax.</sub>/I<sub>Vmin.</sub> ≤ 1.6

<sup>3)</sup> Forward voltages are tested at a current pulse duration of 1 ms and a tolerance of ± 0.1 V

LUMINOUS INTENSITY CLASSIFICATION		
GROUP	LIGHT INTENSITY (mcd)	
	MIN.	MAX.
AB	1400	1800
BA	1800	2240
BB	2240	2850

Note:

Luminous intensity is tested at a current pulse duration of 25 ms and an accuracy of ± 11 %.

The above type numbers represent the order groups which include only a few brightness groups. Only one group will be shipped on each reel (there will be no mixing of two groups on each reel). In order to ensure availability, single brightness groups will not be orderable.

In a similar manner for colors where wavelength groups are measured and binned, single wavelength groups will be shipped on any one reel.

In order to ensure availability, single wavelength groups will not be orderable.

COLOR CLASSIFICATION				
GROUP	YELLOW		AMBER	
	DOM. WAVELENGTH (nm)			
	MIN.	MAX.	MIN.	MAX.
X	585	588		
Y	588	591		
Z	591	594		
W			610	615
X			615	621

Note:

Wavelengths are tested at a current pulse duration of 25 ms and an accuracy of ± 1 nm.

CROSSING TABLE	
VISHAY	OSRAM
VLMK32ABBB-GS08	LAE6SF-AABB
VLMY32ABBB-GS08	LYE6SF-AABB

**TYPICAL CHARACTERISTICS**

$T_{amb} = 25\text{ }^{\circ}\text{C}$ , unless otherwise specified

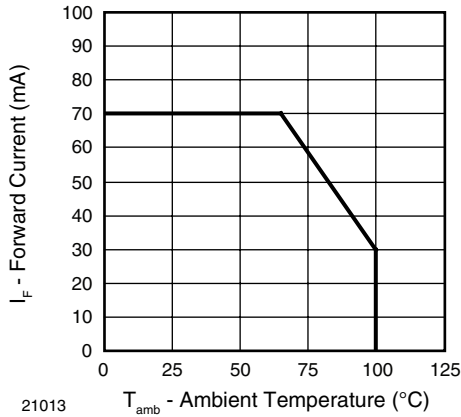

Figure 1. Forward Current vs. Ambient Temperature

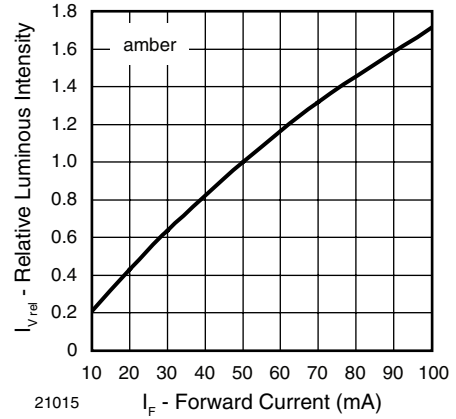

Figure 4. Relative Luminous Intensity vs. Forward Current

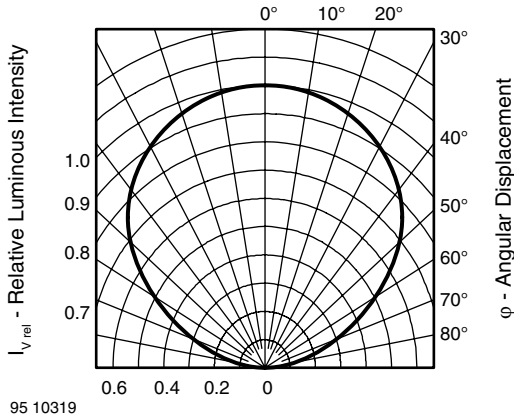

Figure 2. Rel. Luminous Intensity vs. Angular Displacement

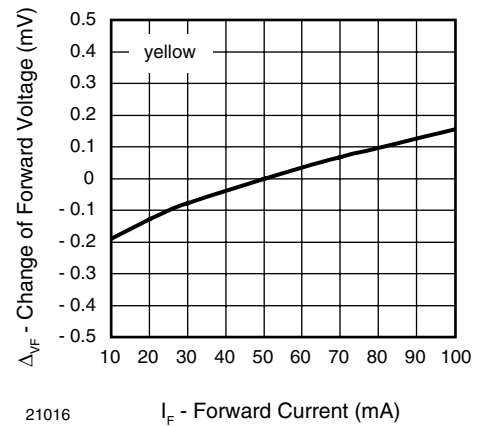

Figure 5. Change of Forward Voltage vs. Forward Current

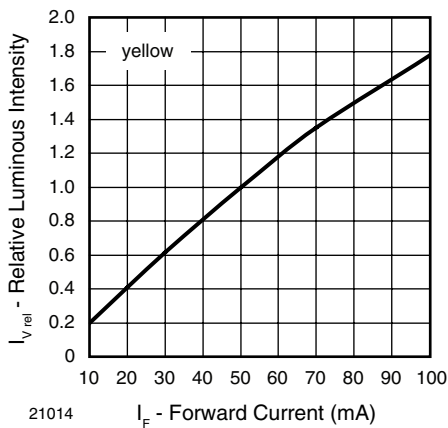

Figure 3. Relative Luminous Intensity vs. Forward Current

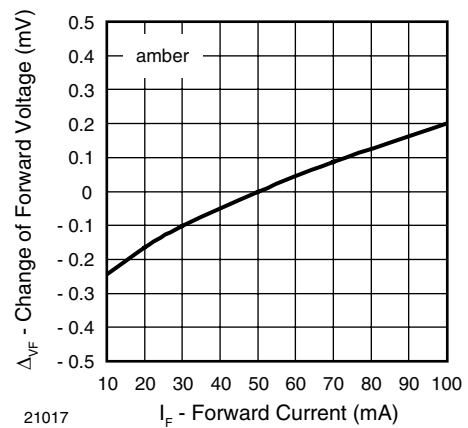

Figure 6. Change of Forward Voltage vs. Forward Current

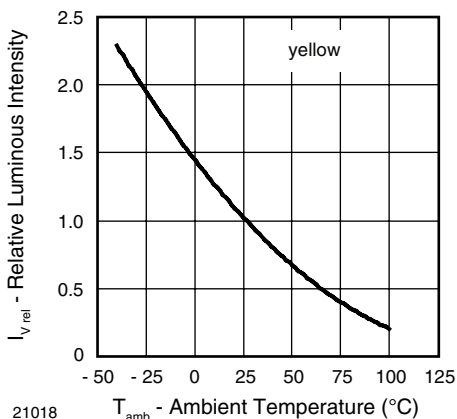

Figure 7. Relative Lum. Intensity vs. Ambient Temperature

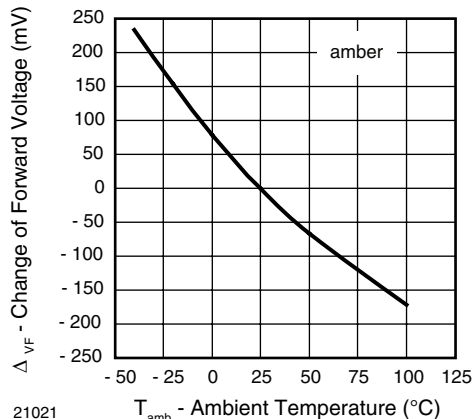

Figure 10. Change of Forward Voltage vs. Ambient Temperature

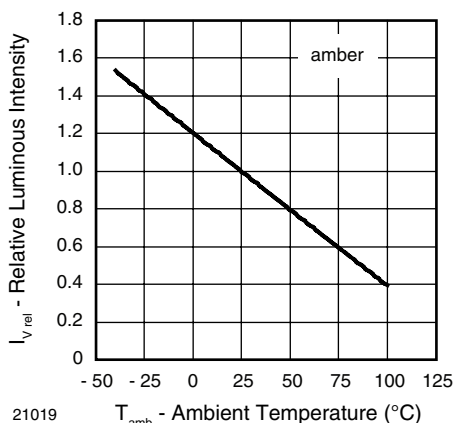

Figure 8. Relative Lum. Intensity vs. Ambient Temperature

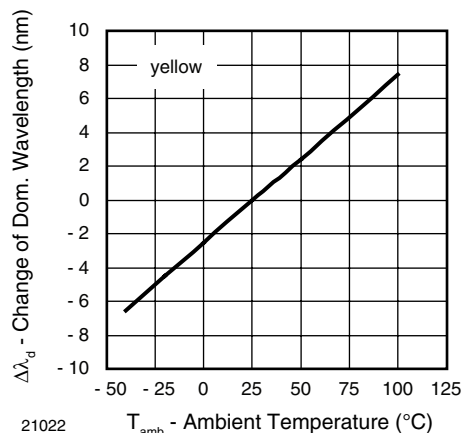

Figure 11. Change of Dominant Wavelength vs. Ambient Temperature

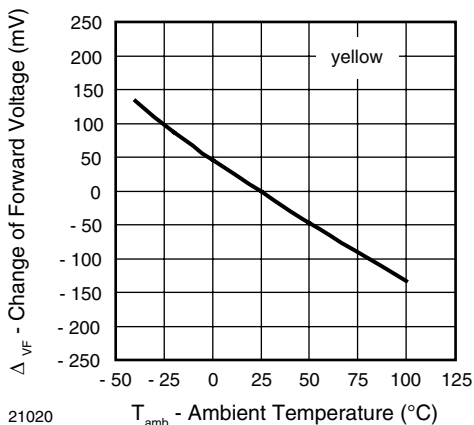

Figure 9. Change of Forward Voltage vs. Ambient Temperature

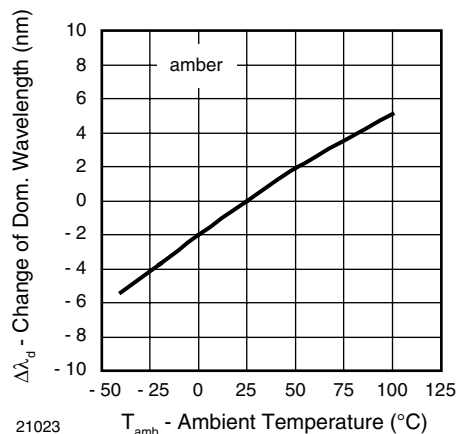

Figure 12. Change of Dominant Wavelength vs. Ambient Temperature

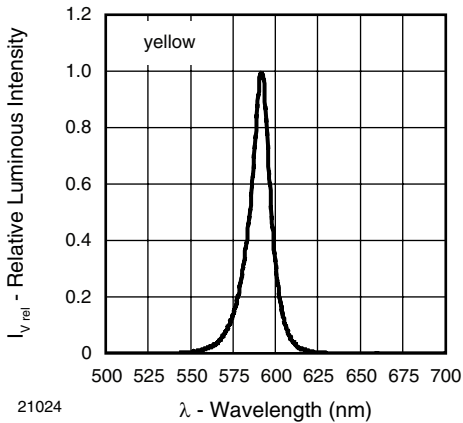

Figure 13. Relative Intensity vs. Wavelength

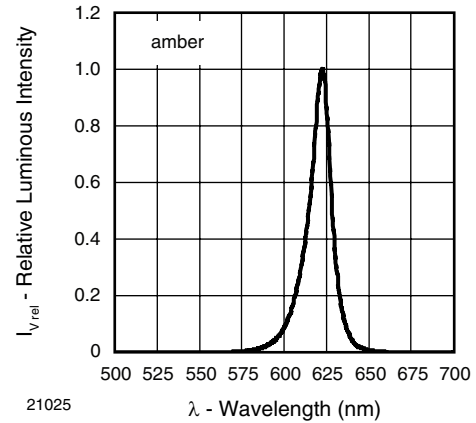
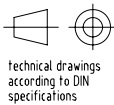
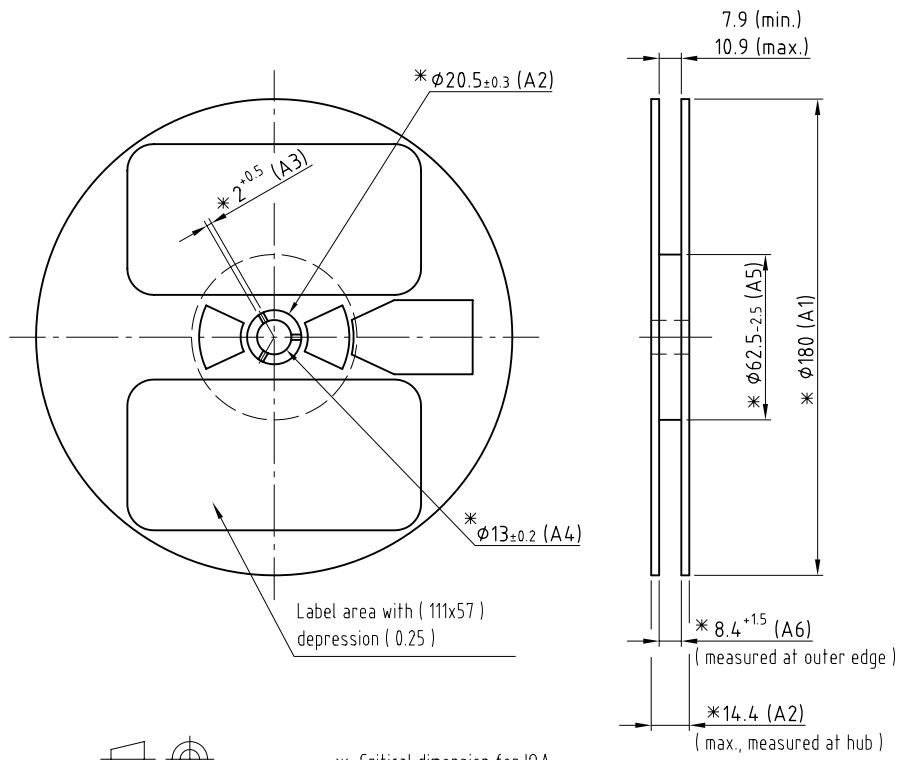

Figure 14. Relative Intensity vs. Wavelength

**REEL DIMENSIONS** in millimeters



\* Critical dimension for IQA.

GS08 = 2000 pcs

Not indicated tolerances ±0.05  
Material: black static dissipative

Drawing refers to following types: φ180 mm Plastic reel

Drawing-No.: 9.800-5086.01-4

Issue: 2; 05.05.08

20983

### TAPING DIMENSIONS in millimeters

#### Taping and orientation

180 reel come in quantity of 2000 units

330 reel come in quantity of 8000 units

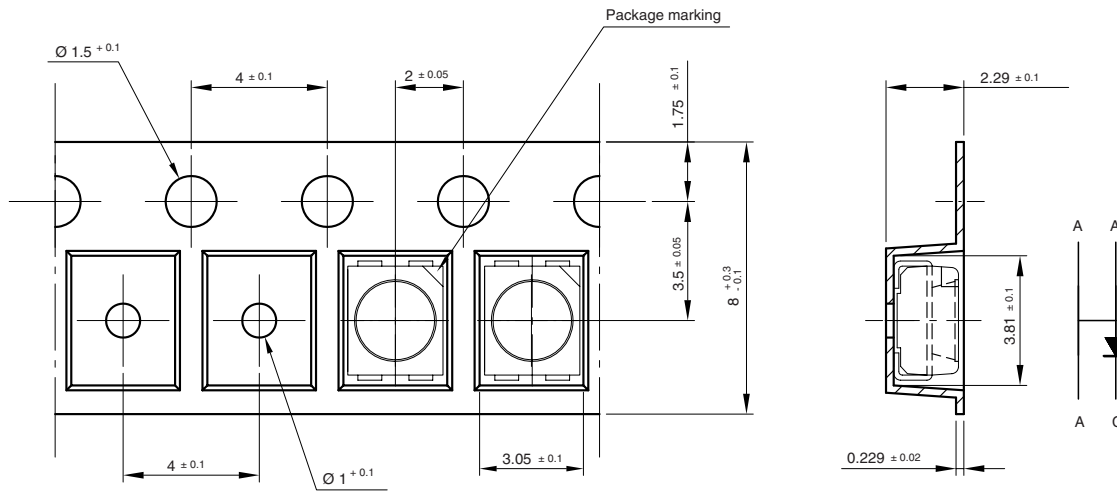

200 mm min. for 180 reel  
200 mm min. for 330 reel

480 mm min. for 180 reel  
960 mm min. for 330 reel

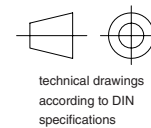
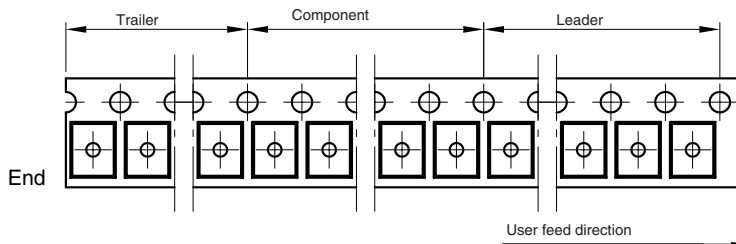

Drawing-No.: 9.700-5334.01-4

Issue: 3; 27.11.08

21066

**PACKAGE/SOLDERING PADS DIMENSIONS** in millimeters

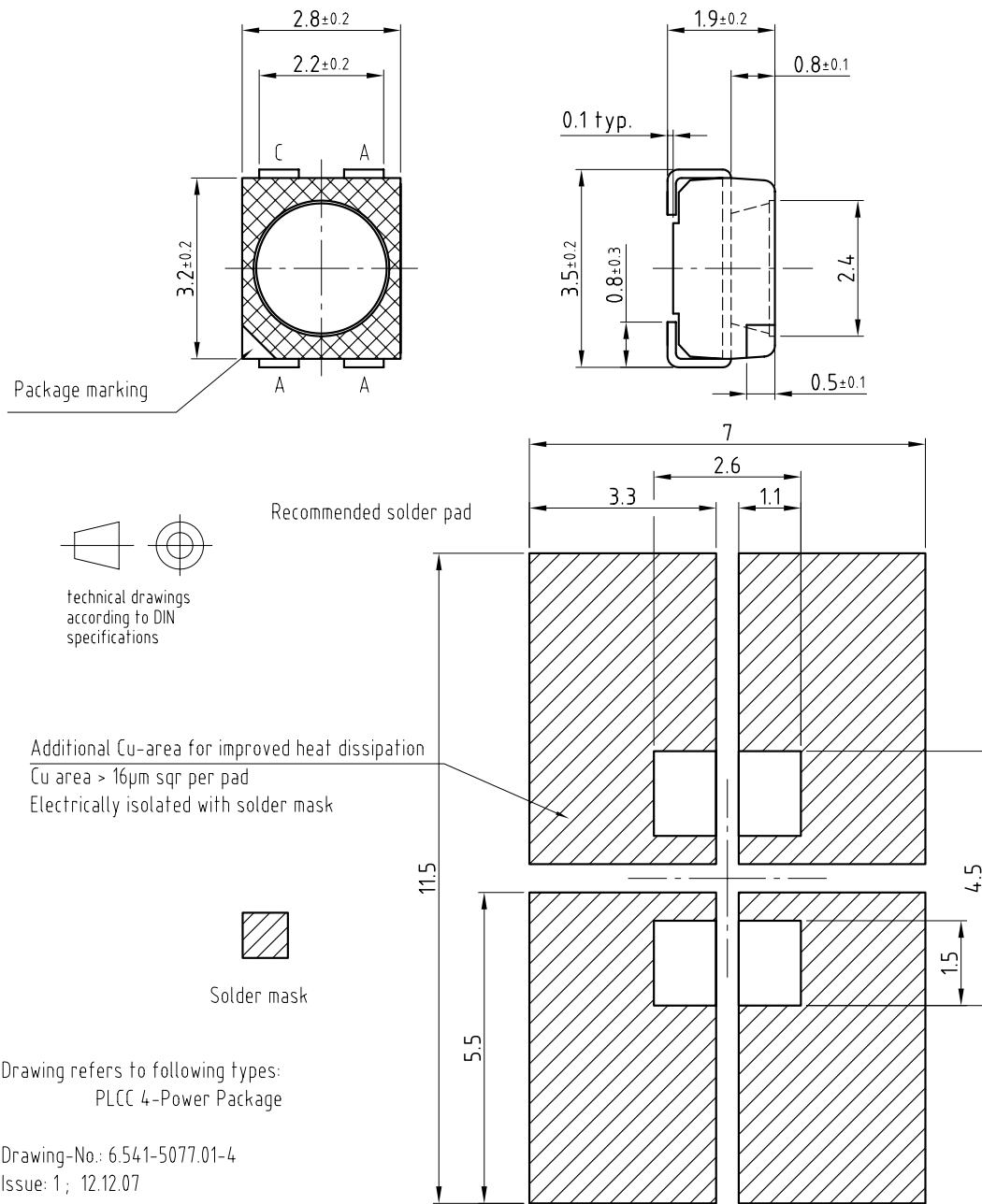

### SOLDERING PROFILE

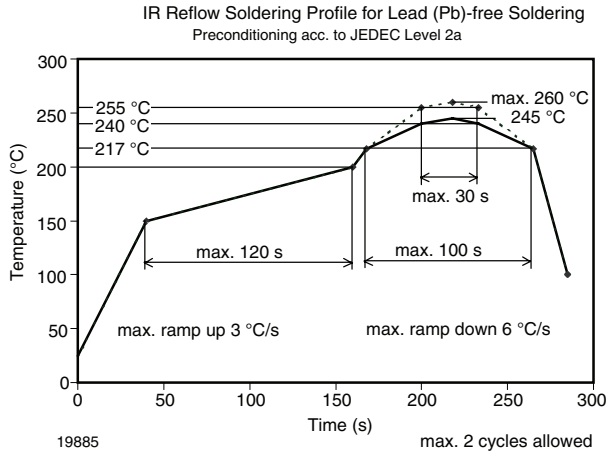

Figure 15. Vishay Lead (Pb)-free Reflow Soldering Profile (acc. to J-STD-020B)

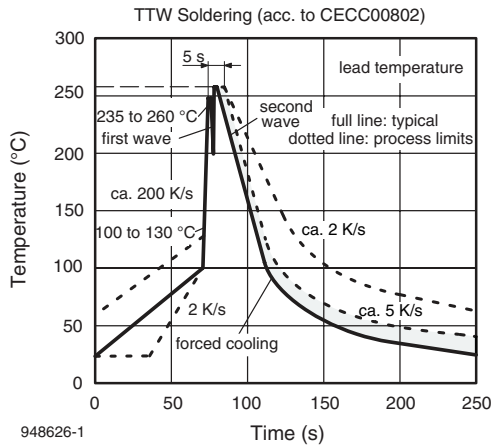
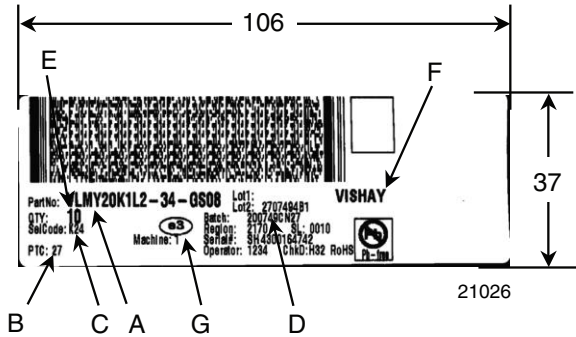

Figure 16. Double Wave Soldering of Opto Devices (all Packages)

### BAR CODE PRODUCT LABEL EXAMPLE:



- A) Type of component
- B) PTC = manufacturing plant
- C) SEL - selection code (bin):  
e.g.: K2 = code for luminous intensity group  
4 = code for color group
- D) Batch/date code
- E) Total quantity
- F) Company code
- G) Code for lead (Pb)-free classification (e3)

### DRY PACKING

The reel is packed in an anti-humidity bag to protect the devices from absorbing moisture during transportation and storage.

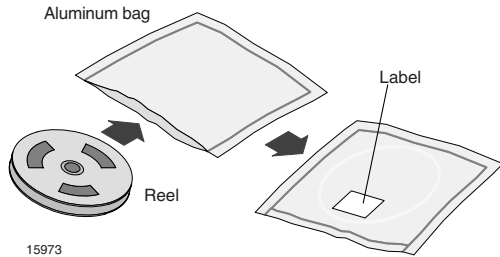

### FINAL PACKING

The sealed reel is packed into a cardboard box. A secondary cardboard box is used for shipping purposes.

### RECOMMENDED METHOD OF STORAGE

Dry box storage is recommended as soon as the aluminum bag has been opened to prevent moisture absorption. The following conditions should be observed, if dry boxes are not available:

- Storage temperature 10 °C to 30 °C
- Storage humidity  $\leq 60\%$  RH max.

After more than 672 h under these conditions moisture content will be too high for reflow soldering.

In case of moisture absorption, the devices will recover to the former condition by drying under the following condition:

192 h at 40 °C + 5 °C/- 0 °C and < 5 % RH (dry air/nitrogen) or

96 h at 60 °C + 5 °C and < 5 % RH for all device containers or

24 h at 100 °C + 5 °C not suitable for reel or tubes.

An EIA JEDEC standard JESD22-A112 level 2a label is included on all dry bags.

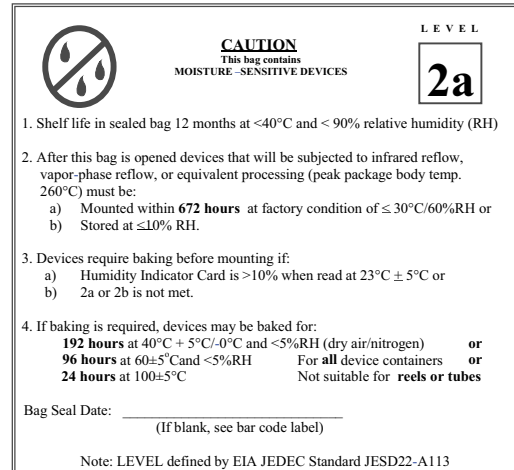

Example of JESD22-A112 level 2a label

### ESD PRECAUTION

Proper storage and handling procedures should be followed to prevent ESD damage to the devices especially when they are removed from the antistatic shielding bag. Electro-static sensitive devices warning labels are on the packaging.

### VISHAY SEMICONDUCTORS STANDARD BAR CODE LABELS

The Vishay Semiconductors standard bar code labels are printed at final packing areas. The labels are on each packing unit and contain Vishay Semiconductors specific data.



## Disclaimer

All product specifications and data are subject to change without notice.

Vishay Intertechnology, Inc., its affiliates, agents, and employees, and all persons acting on its or their behalf (collectively, "Vishay"), disclaim any and all liability for any errors, inaccuracies or incompleteness contained herein or in any other disclosure relating to any product.

Vishay disclaims any and all liability arising out of the use or application of any product described herein or of any information provided herein to the maximum extent permitted by law. The product specifications do not expand or otherwise modify Vishay's terms and conditions of purchase, including but not limited to the warranty expressed therein, which apply to these products.

No license, express or implied, by estoppel or otherwise, to any intellectual property rights is granted by this document or by any conduct of Vishay.

The products shown herein are not designed for use in medical, life-saving, or life-sustaining applications unless otherwise expressly indicated. Customers using or selling Vishay products not expressly indicated for use in such applications do so entirely at their own risk and agree to fully indemnify Vishay for any damages arising or resulting from such use or sale. Please contact authorized Vishay personnel to obtain written terms and conditions regarding products designed for such applications.

Product names and markings noted herein may be trademarks of their respective owners.