

**Ordering number C11814_SANDRA-12-M**

Family	Sandra	FWHM	27 degrees
Type	Lens array	Efficiency	86 %
LED	NCSxx19A	cd/lm	2.400
Color	Clear	Gerber File	Available
Diameter	67 mm		
Height	11.1 mm		
Style	Round		
Optic Material	PMMA		
Holder Material	-		
Fastening	Pin, glue		
Status	Ready		

Ordering number C11700_SANDRA-12-W

Family	Sandra	FWHM	29 degrees
Type	Lens array	Efficiency	87 %
LED	NCSxx19A	cd/lm	2.200
Color	Clear	Gerber File	Available
Diameter	67 mm		
Height	11.1 mm		
Style	Round		
Optic Material	PMMA		
Holder Material	-		
Fastening	Pin, glue		
Status	Ready		

NOTE: The typical divergence will be changed by different color, chip size and chip position tolerance. The typical total divergence is the full angle measured where the luminous intensity is half of the peak value.



PRODUCT DATASHEET

Sandra series

last update 28/3/2013



GENERAL INFORMATION

- Product series especially designed & optimized for NCSxx19A series of LEDs.
- Special care taken to make light distribution as uniform as possible.
- Lens material optical grade PMMA with high UV and temperature resistance. Allows use of high current and temperature conditions.

Please find more information about used material from below:

http://ledil.fi/sites/default/files/Documents/Technical/Material/PMMA%20N%20UL94_Yellow%20Card.pdf

<http://ledil.fi/sites/default/files/Documents/Technical/Material/PMMA%20N%20PLEXIGLAS-Datasheet.pdf>

Relative intensity of C11700_Sandra-12-W-XP

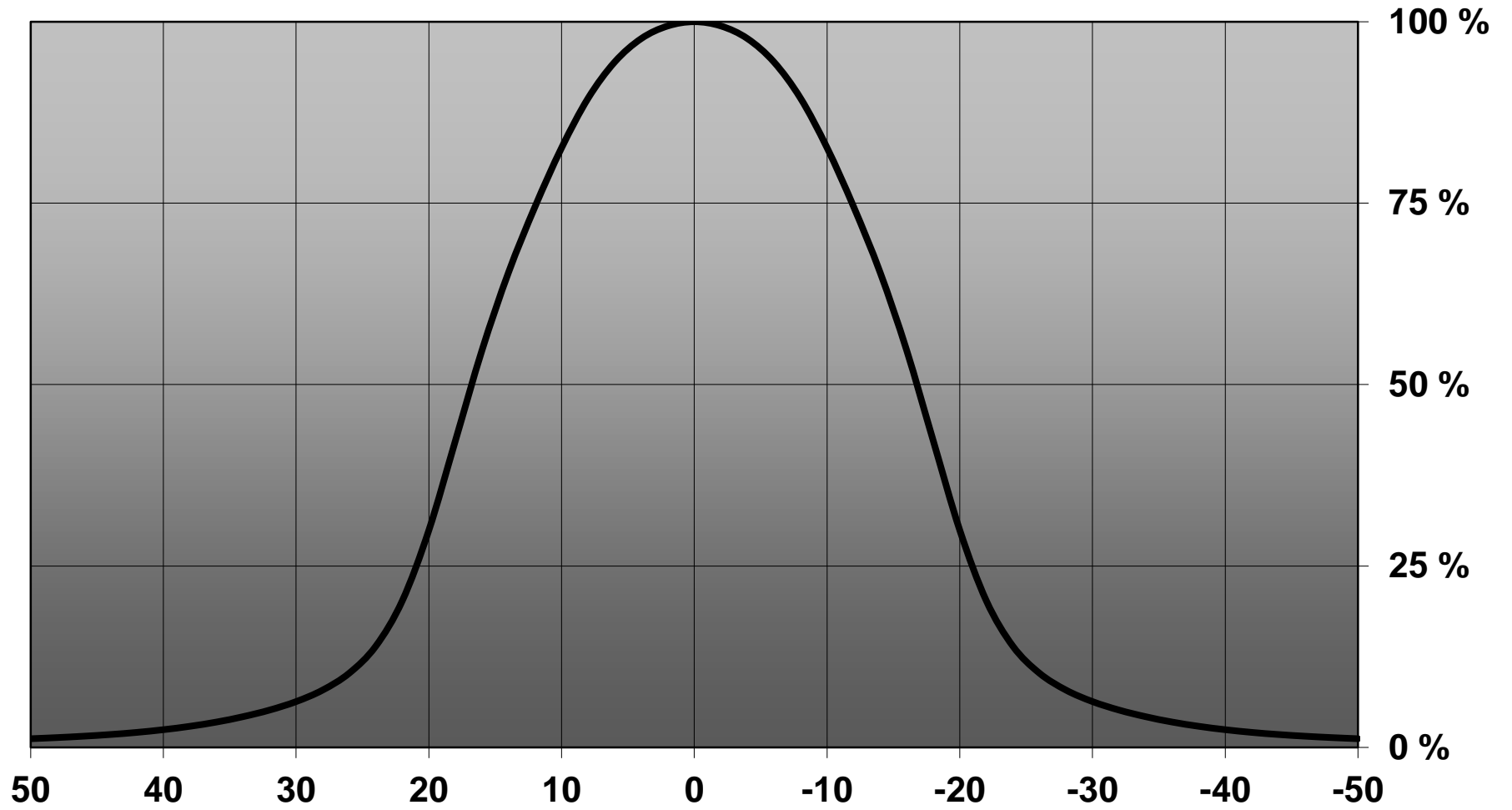

D

C

B

A

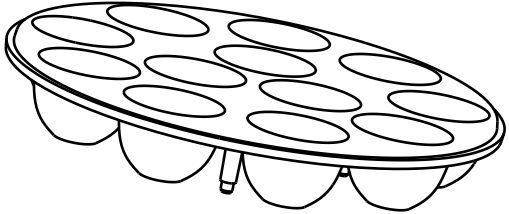

Isometric view
Scale: 1:1

4

4

3

3

2

2

1

1

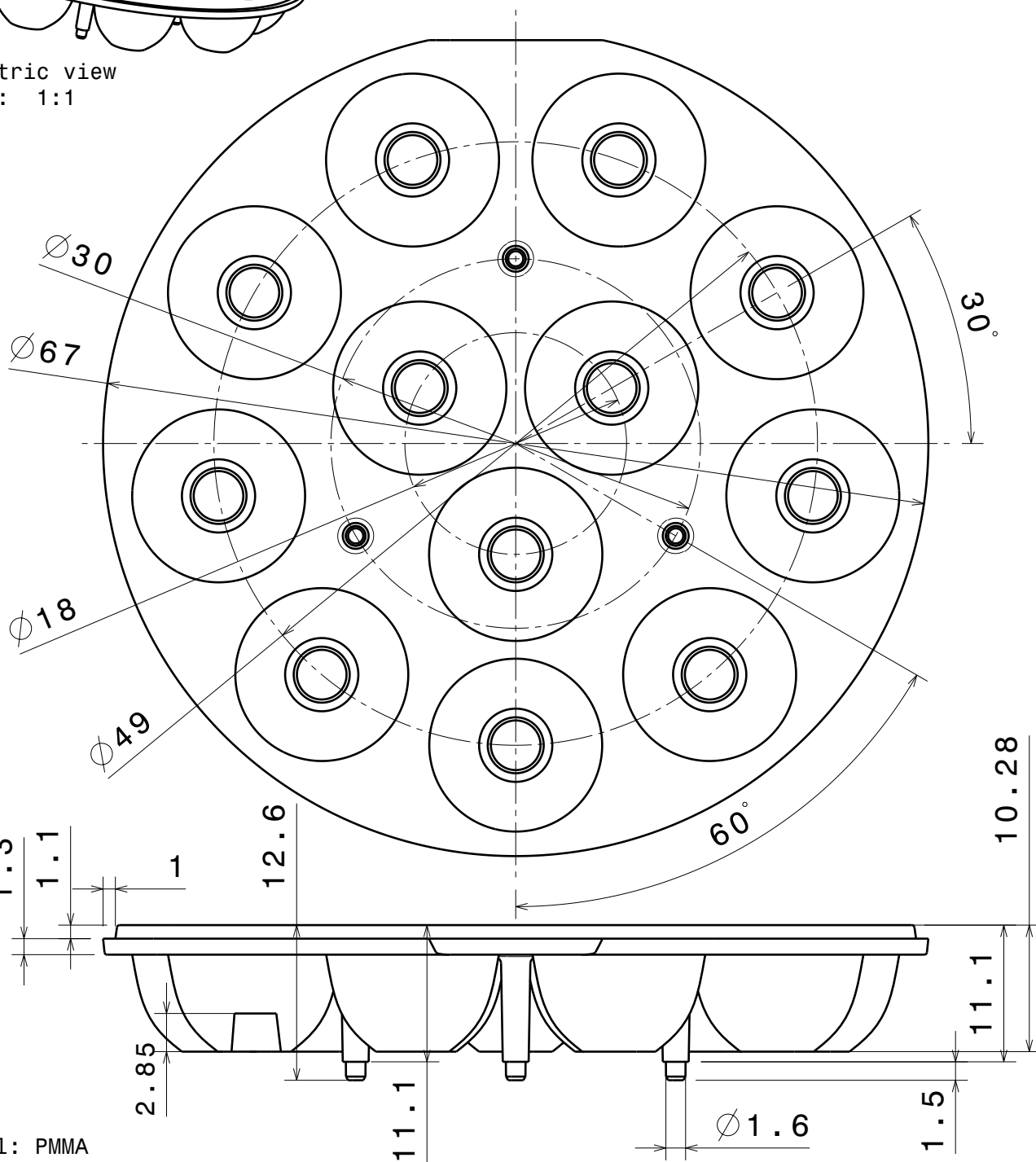

Material: PMMA

This drawing is our property.
It can't be reproduced
or communicated without
our written agreement.



Ledil Oy
Salorankatu 10
FIN-24100 SALO
Finland

DRAWING TITLE
Datasheet Sandra-12 series lens

DRAWN BY
ah
DATE
31.12.2012

CHECKED BY
DATE
SIZE
A4

DRAWING NUMBER
-
REV
1

DESIGNED BY
hh
DATE
27.08.2010

SCALE
2:1
WEIGHT (g)
SHEET
1/1

D

A

Luminaire: LEDIL OY C11814_SANDRA-12-M (NCS19) Efficiency=86%
Lamps: 1 x Nichia NCS19 (565lm@250mA)

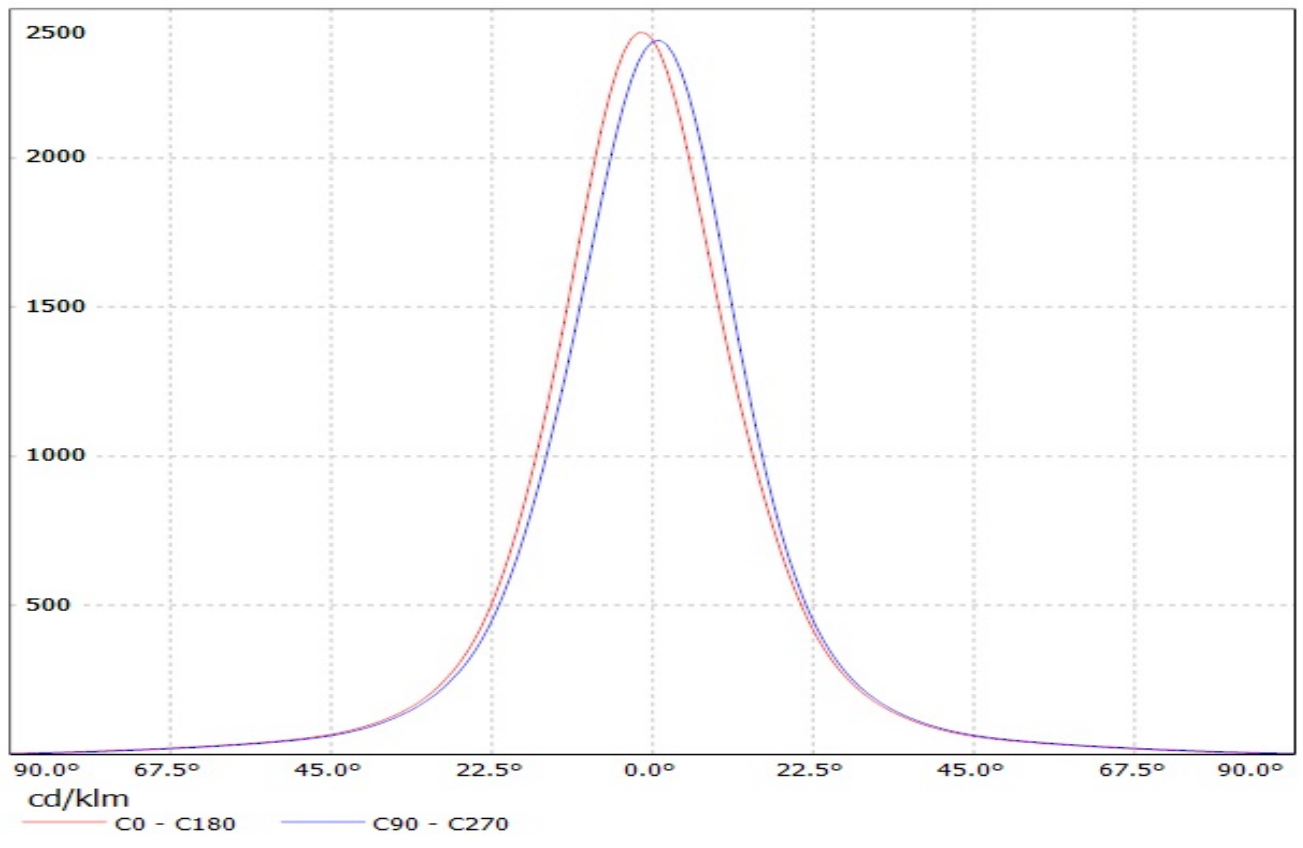

Luminaire: LEDIL OY C11700_SANDRA-12-W (NCS19) Efficiency=87%
Lamps: 1 x Nichia NCS19 (565lm@250mA)

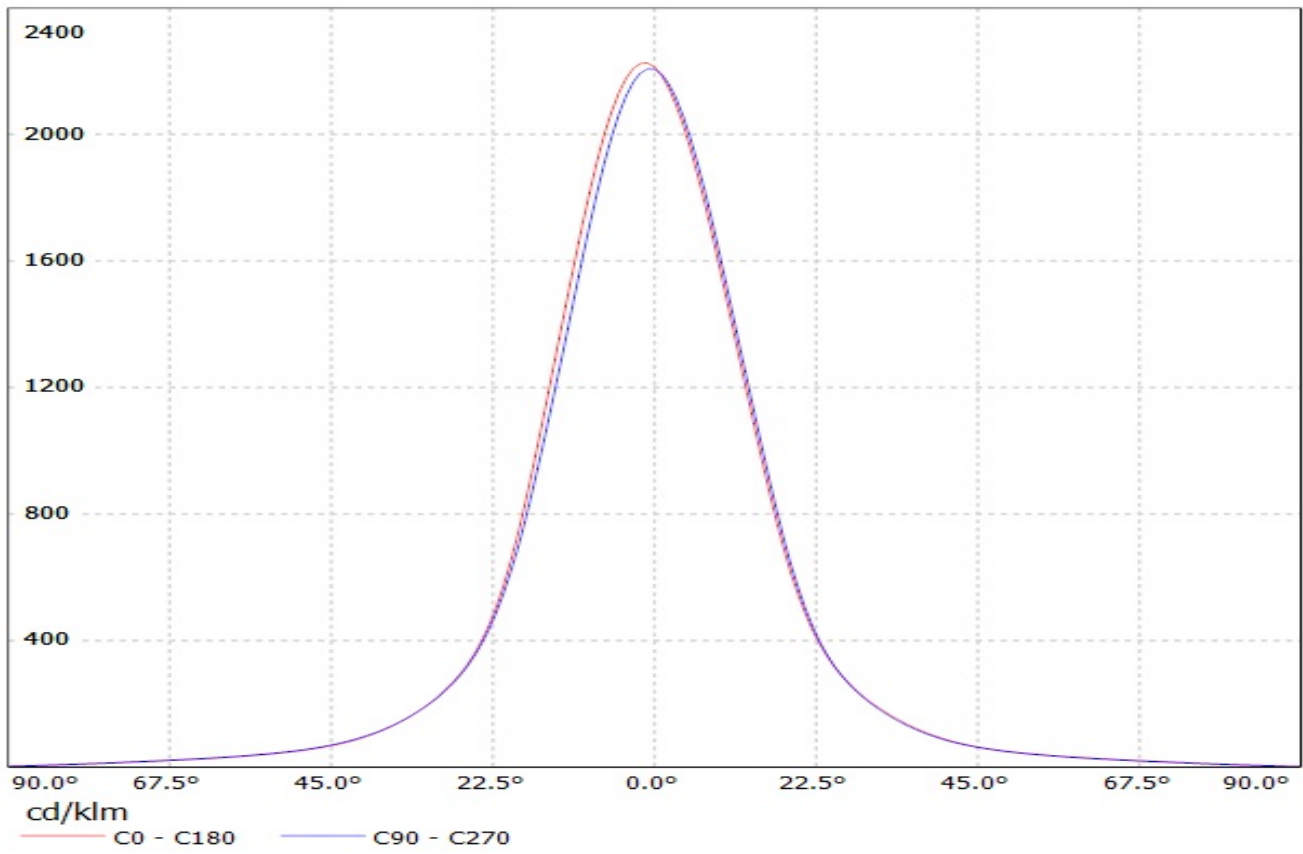

Luminaire: LEDIL OY C11814_SANDRA-12-M (NCS19) Efficiency=86%
Lamps: 1 x Nichia NCS19 (565lm@250mA)

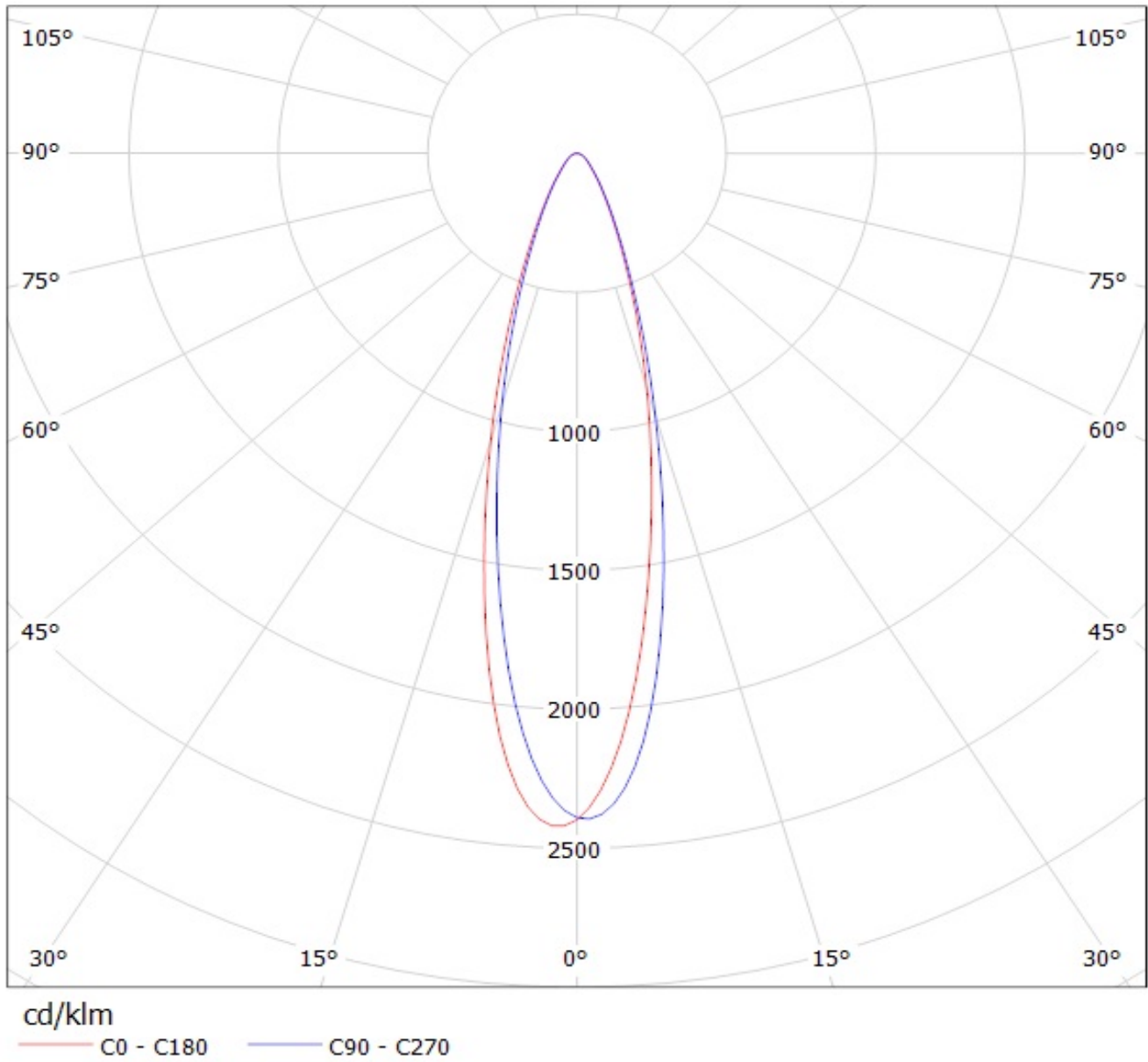

Luminaire: LEDIL OY C11700_SANDRA-12-W (NCS19) Efficiency=87%

Lamps: 1 x Nichia NCS19 (565lm@250mA)

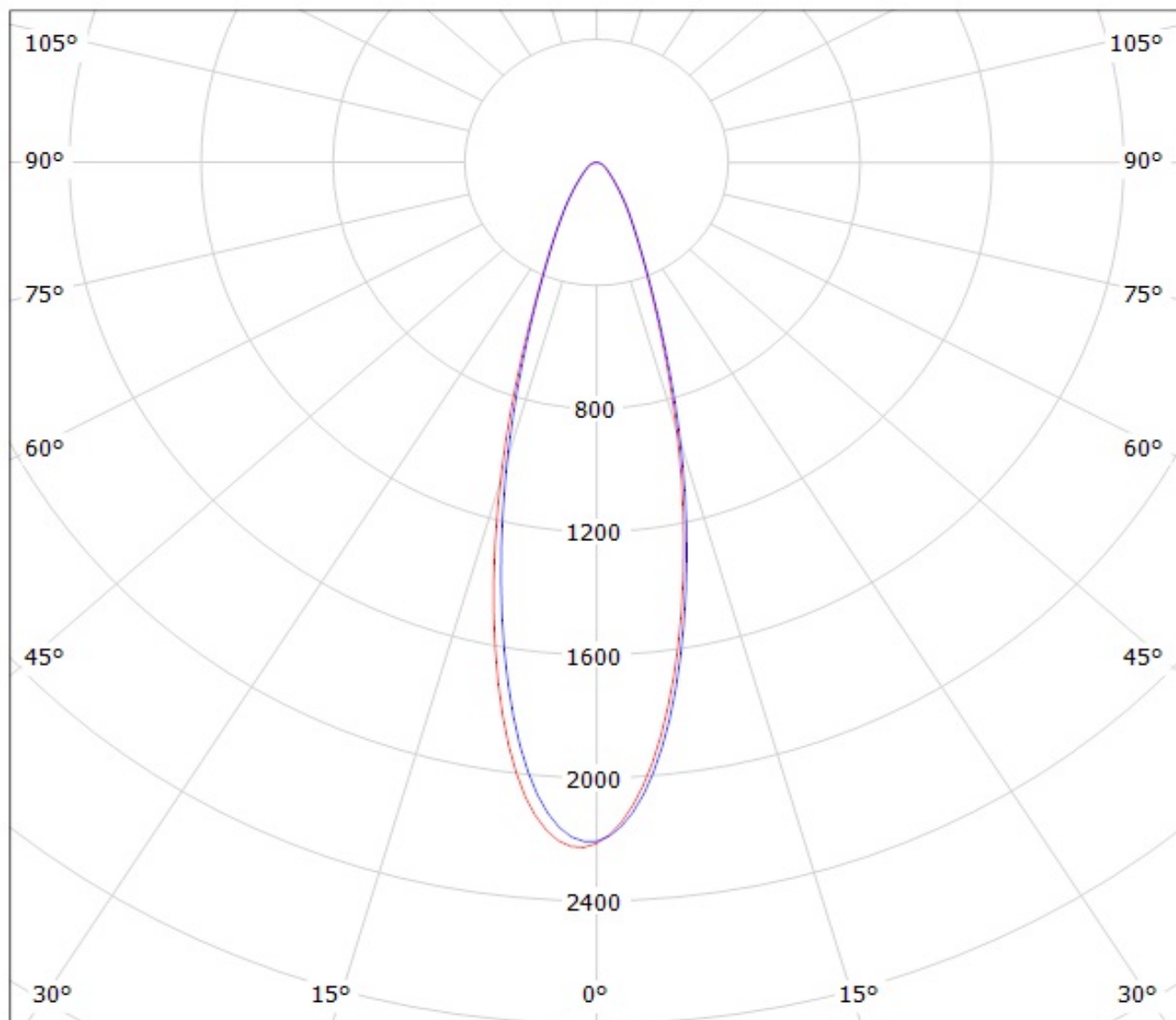

cd/klm

— C0 - C180

— C90 - C270