



## Emergency stop button non-illumin.







Powering Business Worldwide™



**Part no.** M22-PV  
**Article no.** 216876  
**Catalog No.** M22-PVQ

### Delivery programme

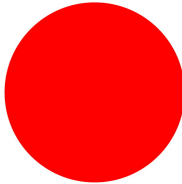
Approval			   
Product range			RMQ-Titan (drilling dimensions 22.5 mm)
Basic function			Emergency stop pushbutton/ emergency-stop button
Description			Pull to release
Construction type			Mushroom-shaped
Diameter	∅	mm	38
Colour			
Mushroom head			Red
RAL Value			RAL 3000
			
Function			Pull-release
Illumination			Without illumination
Front ring			without front ring
Connection to SmartWire-DT			yes
<b>Instructions</b>			Release by pulling
<b>Notes</b>			
Release by pulling			
Button diameter 38 mm			

### Approvals

Product Standards	IEC/EN 60947-5; UL 508; CSA-C22.2 No. 14-05; CSA-C22.2 No. 94-91; CE marking
UL File No.	E29184
UL Category Control No.	NKCR
CSA File No.	012528
CSA Class No.	3211-03
North America Certification	UL listed, CSA certified
Degree of Protection	UL/CSA Type 3R, 4X, 12, 13

### General

Standards			IEC/EN 60947 VDE 0660
Lifespan, mechanical	Operations	x 10 <sup>6</sup>	> 0.1
Operating frequency	Operations/ h		 600
Actuating force		n	50
Protection type			IP66, IP69K
Climatic proofing			Damp heat, constant, to IEC 60068-2-78 Damp heat, cyclic, to IEC 60068-2-30
Ambient temperature		°C	
Open		°C	- 25 - + 70

Mounting position		As required
Mechanical shock resistance	g	50 Shock duration 11 ms Sinusoidal according to IEC 60068-2-27

## Technical data ETIM 5.0

Low-voltage industrial components (EG000017) / Front element for mushroom push-button (EC001038)

Electric engineering, automation, process control engineering / Low-voltage switch technology / Command and alarm device / Front element for mushroom push-button actuators (ecl@ss8-27-37-12-12 [AKF030010])

Colour button		Red
Construction type lens		Round
Diameter cap	mm	38
Hole diameter	mm	22
Width opening	mm	22
Height meter opening	mm	6
Degree of protection (IP)		IP66
Type of button		Flat
Suitable for illumination		No
Switching function latching		Yes
Spring-return		No
With front ring		No
Material front ring		Plastic
Colour front ring		Chrome
Suitable for emergency stop		Yes
Unlocking method		Pull release

## Dimensions

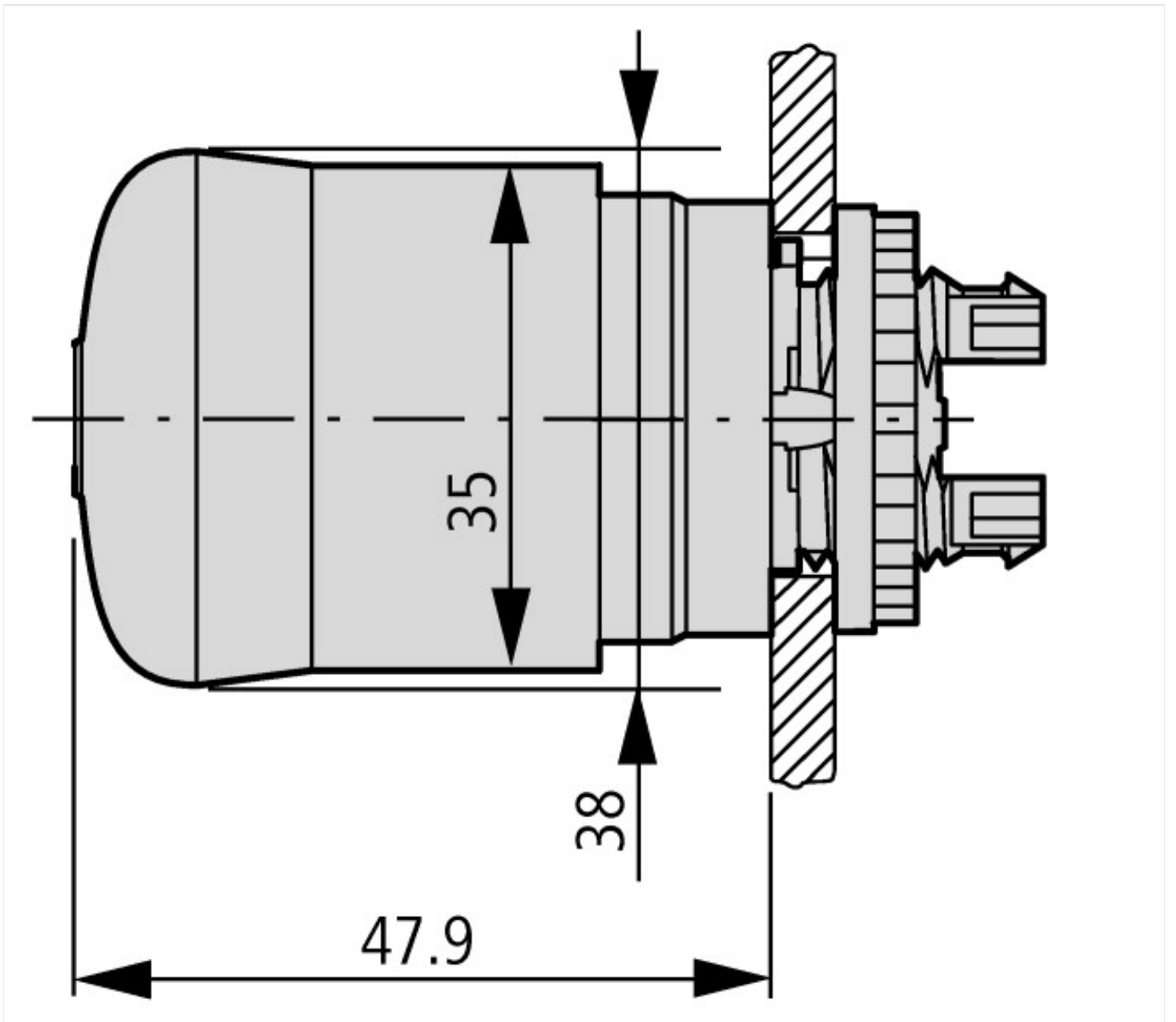

#### Additional product information (links)

IL04716005Z RMQ-Titan: Emergency stop buttons, Emergency stop buttons | IL04716002Z\*.pdf;IL04716002Z

IL04716005Z RMQ-Titan: Emergency stop buttons, Emergency stop buttons | IL04716002Z\*.pdf;IL04716002Z

[ftp://ftp.moeller.net/DOCUMENTATION/AWA\\_INSTRUCTIONS/IL04716005Z2012\\_02.pdf](ftp://ftp.moeller.net/DOCUMENTATION/AWA_INSTRUCTIONS/IL04716005Z2012_02.pdf)