

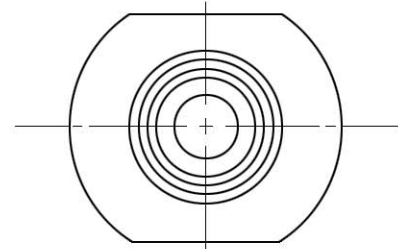

No.	Changes and/or Note No.	Date	Intr.	No.	Changes and/or Note No.	Date	Intr.

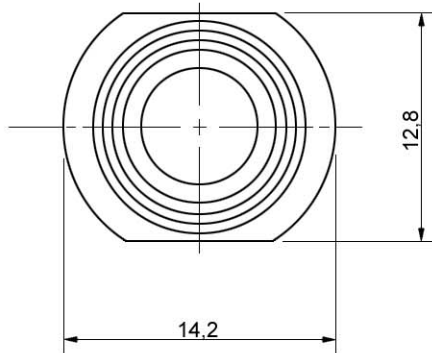
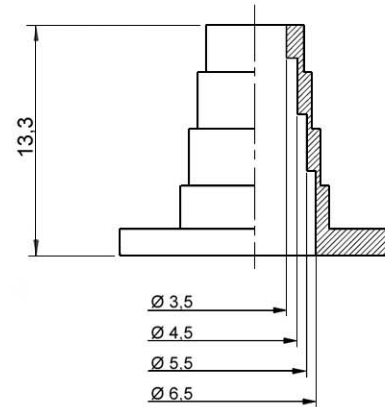
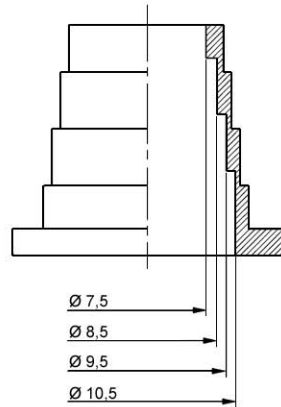
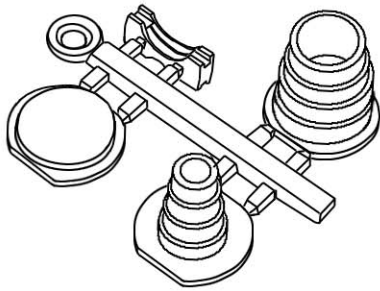

DATE 2006-11-08	DRAWN MRR	SCALE	MATERIAL TYPE
	APPROVED		REPLACES
	MHEE-D1 Metalized Plastic Grommets		
			DRAWING No 156