

TOLERANCES (UNLESS SPECIFIED)	
0-10mm	±0.2mm
10.1-50mm	±0.5mm
50.1-250mm	±1.0mm
>250mm	±2.0mm

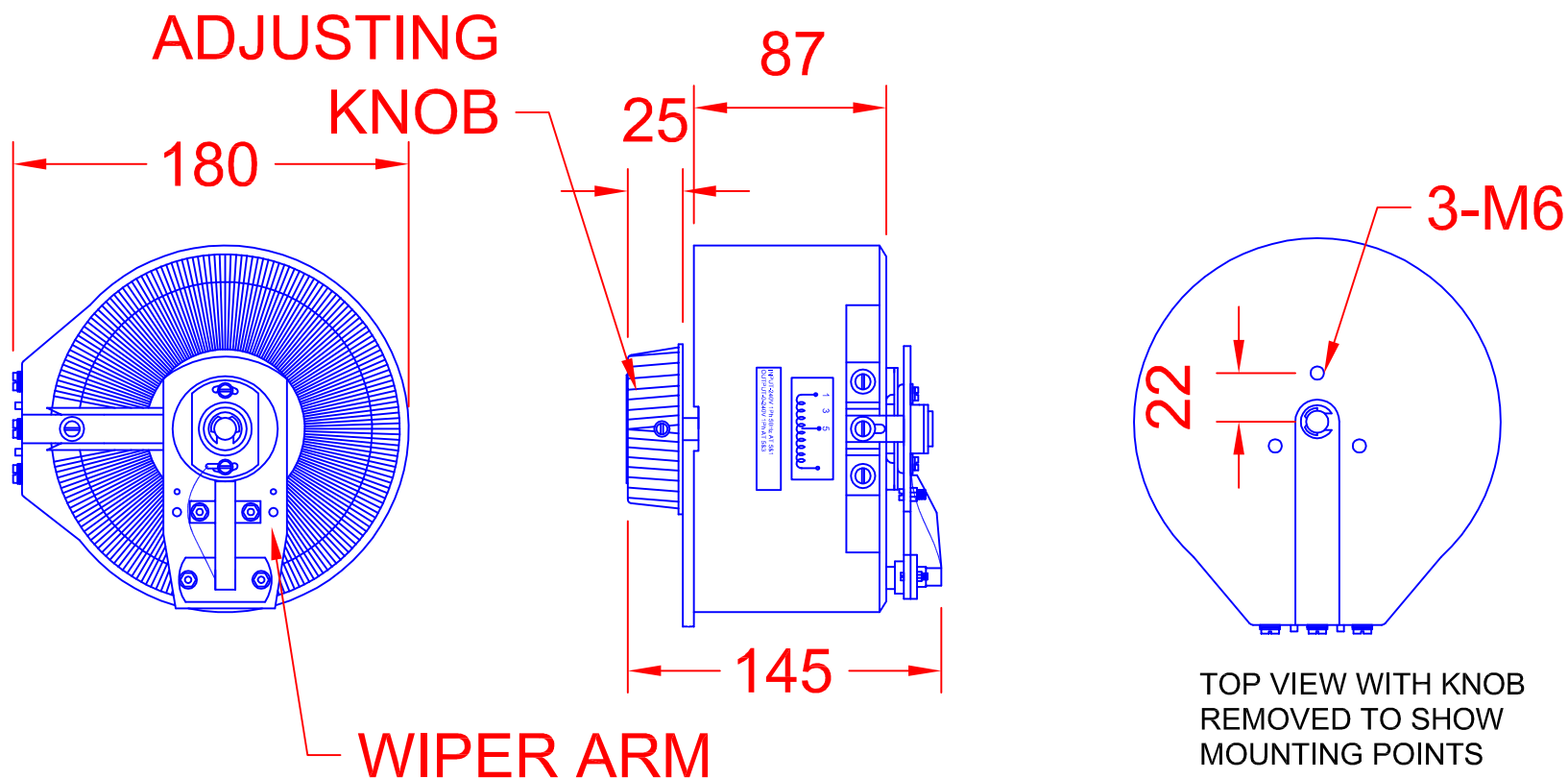

VARIAC

MODEL CMV6X-1
 INPUT 240V
 OUTPUT 0-240V
 RATED 6 AMPS

TERMINATIONS M4 BOLTS

- 1 LIVE 240V I/P
- 3 LIVE O/P (VARIABLE)
- 5 NEUTRAL I/P AND O/P

REV	
4	
3	
2	
1	

CARROLL & MEYNELL
 TRANSFORMERS LIMITED
 TEL: 01642 617406 FAX: 01642 614178
 enquiries@carroll-meynell.com

TITLE SINGLE PHASE
 ENCASULATED VARIAC
 CMV6X-1
 ALL DIMENSIONS IN mm

DRAWN	PROJECTION	DATE	SCALE
SH		27/5/8	NTS
DRAW No	REV	PAGE	
6090	0	1/1	