

Datasheet

Miniature & Standard Thermocouple Connectors – High Temperature Plastic

Thermocouple types 'K' & 'J' available in standard or miniature sizes



Type 'K' miniature (see below for type 'J')

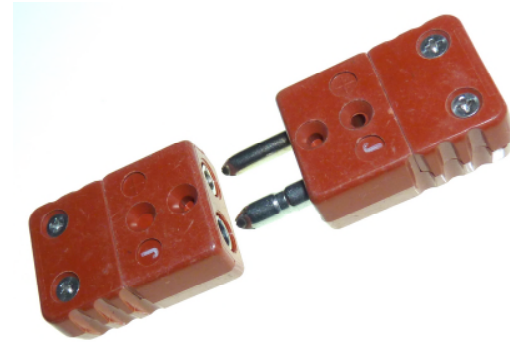

Type 'J' standard (see below for type 'K')

- Available in standard and miniature format
- High temperature for use up to 425°C
- Heavy duty plastic body made from high strength thermoset plastic
- Available in thermocouple type 'K', 'N' or 'J'
- Miniature size plugs & sockets with flat pins or standard size with round pins
- Contacts are polarised to prevent incorrect connection
- All types colour coded – Brown

Miniature Connectors:

T/C Type	Size	Connector type	Product Code	RS order code
K	Miniature	Plug	70646178	611-8113
J	Miniature	Plug	70646181	611-8141
K	Miniature	Socket	70646180	611-8135
J	Miniature	Socket	70646183	611-8163

Standard Connectors

T/C Type	Size	Connector type	Product Code	RS order code
K	Standard	Plug	70643597	363-0137
J	Standard	Plug	70646184	611-8179
N	Standard	Plug	70652531	774-7330
K	Standard	Socket	70643598	363-0159
J	Standard	Socket	70646185	611-8185
N	Standard	Socket	70652532	774-7333

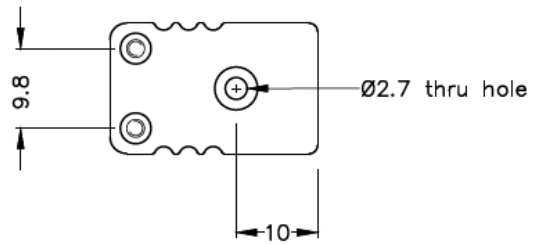
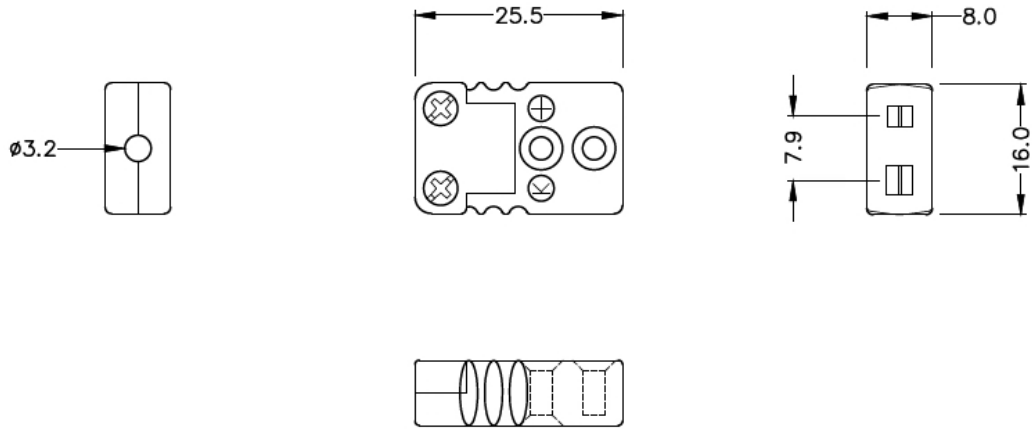

Miniature Hi-Temp Plastic in-line Socket - HTP
(dimensions in mm)

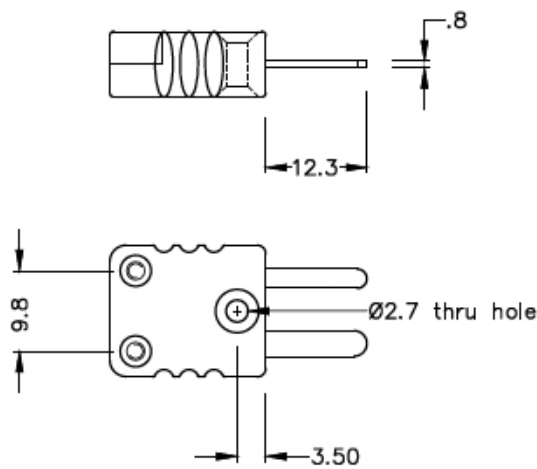
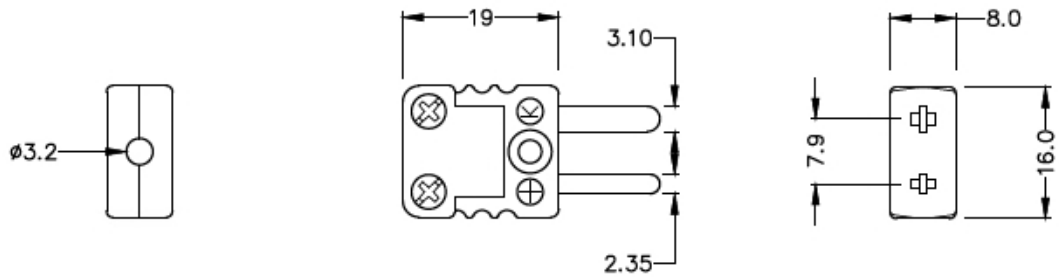

Miniature Hi-Temp Plastic in-line Plug - HTP
(dimensions in mm)

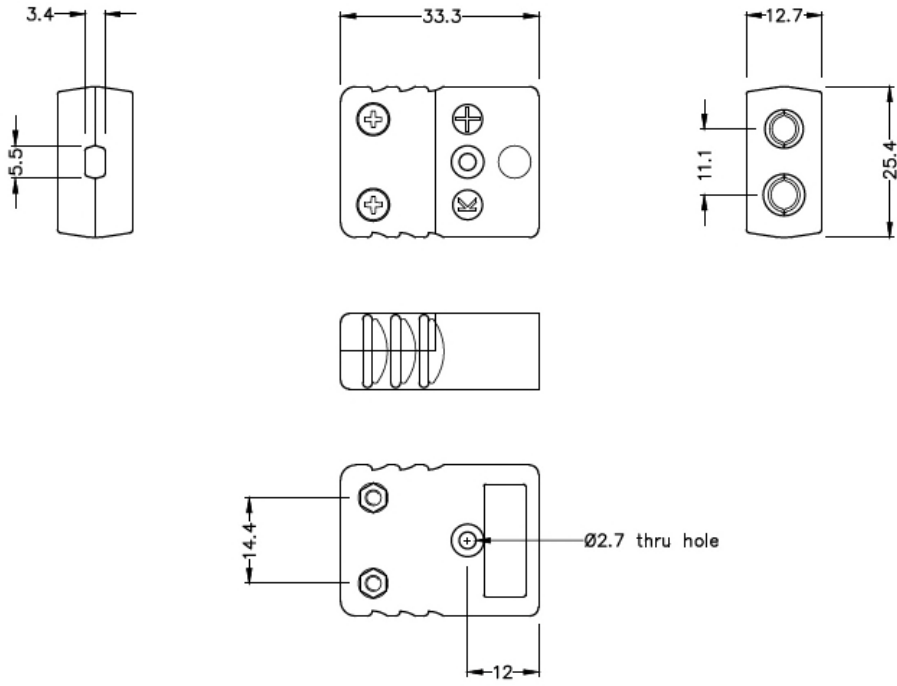

Standard Hi-Temp Plastic in-line Socket - HTP
(dimensions in mm)

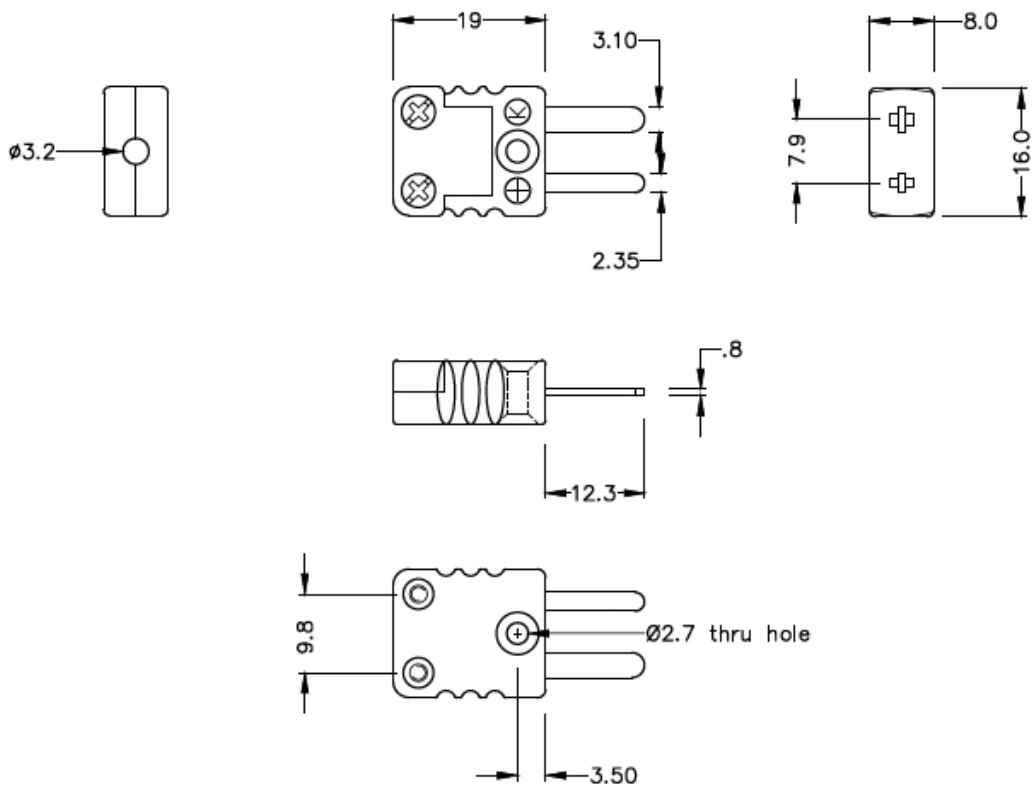

Miniature Hi-Temp Plastic in-line Plug - HTP
(dimensions in mm)

Making your own Thermocouples?

L60 Thermocouple & Fine Wire Welder

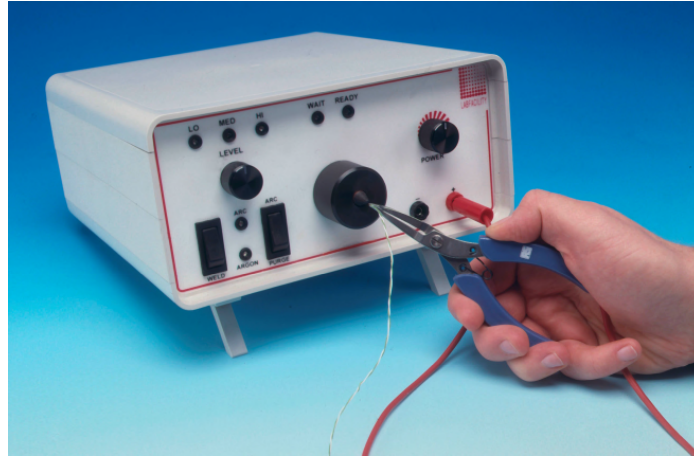

The Thermocouple Welder is a compact, simple-to-use instrument designed for thermocouple and fine wire welding

It is primarily designed for use by sensor manufacturers to produce commercial grade thermocouple junctions; it is ideal for producing large numbers of exposed junction thermocouples for test and development laboratories. The L60 Thermocouple Welder is ideally suited to transducer and RTD extension lead attachment

Use of the Thermocouple Welder does not require special skills and most operatives will be capable of producing quality work with little practice. The instrument is supplied with a full range of user accessories including a footswitch

Suitable for use with wires of up to 1.1mm diameter an argon gas shield facility is included but a satisfactory thermocouple junction is produced without the need for argon. The output energy of the L60 Thermocouple Welder can be varied up to 60 Joules

- Simple to use Thermocouple Welder
- Designed for the production of commercial grade thermocouple junctions (See below for range of thermocouple cables)
- Also suitable for other fine wire work
- Front panel or footswitch operation
- Argon gas shield facility

Supplied complete with the following accessories:

- Wire Holding Pliers & Lead
- Safety Glasses
- Magnifying Eyeglass
- Carbon Electrodes
- Spare 2A Fuse
- Argon Hose
- Mains Lead
- Footswitch for greater ease of use



Carbon Electrode

ORDERING INFORMATION

MODEL

FINE WIRE WELDER

Spare Carbon Electrodes (x5) for 1.1mm 250V Fine Wire Welder

Allied Code

70825788

70656473

RS ORDER NUMBER

363-0351

814-0184

SPECIFICATIONS

General

Energy Output 0-60 Joules
Welding Capacity Wires up to 1.1mm diameter
Duty Cycle Minimum 5-10 welds/min

MECHANICAL

Physical Dimensions 220mm Wide x 120mm High x 250mm Depth
Weight 4kg

ELECTRICAL

Power Supply 110-120 Vac or 220-250 Vac, 50-60Hz
Power Consumption Max 170VA dropping to 20VA during charging

MAINTENANCE

Apart from keeping the electrode in good order, no other maintenance is required

(Front View)

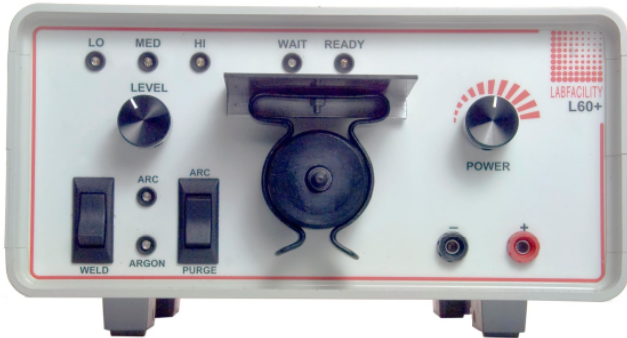

(Rear View)



Thermocouple Welder Controls

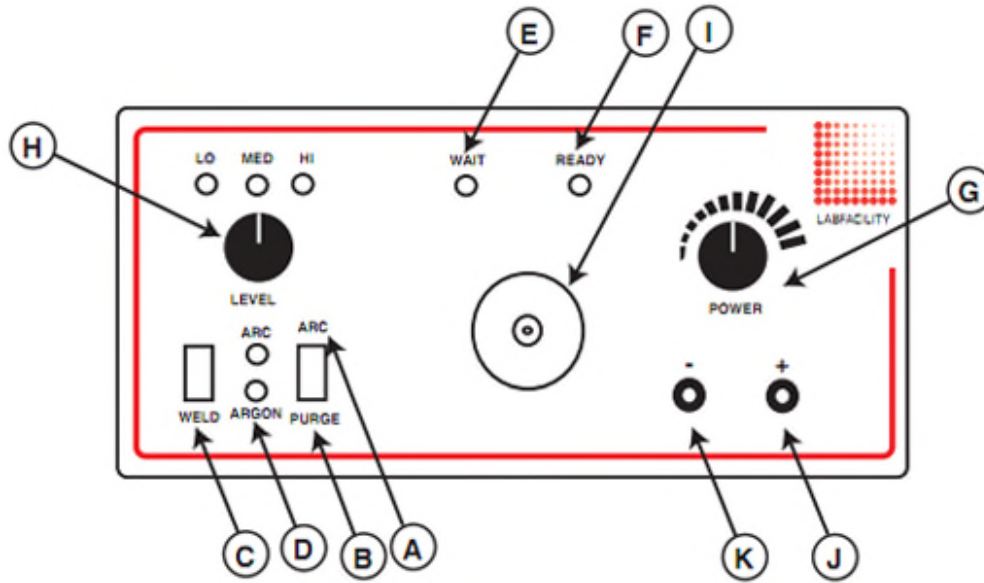

- A Arc Argon gas and weld current controlled by the "Weld" switch. LED indication
- B Purge Allows the gas line and electrode shield to be purged of air prior to a new welding period
- C Weld Switch Initiates a welding operation (in "arc" mode also opens the Argon valve)
- D Argon LED Indicates when the Argon control valve is open and gas is flowing
- E Wait LED Glows when weld charge is building
- F Ready LED "Ready to Weld" indication
- G Power Rotary control of the capacitor charge voltage
- H Level Selector Selects the total capacitance available giving the following values with LED indication
 - "LO" = 0 to 6 Joules
 - "MED" = 0 to 28 Joules
 - "HI" = 0 to 64 Joules

- I Electrode Holder Holds the replaceable carbon electrode which is accessible by removing the outer Argon Shield
- J Red Socket Output socket for using the pliers supplied
- K Black Socket Output socket, this provides an additional earth

IEC PTFE Insulated Twin Twisted Pair Thermocouple Cable

Available in Thermocouple Types K, J T & N



Type 'K'

Type 'T'

- PTFE twin twisted pair for extending or making simple thermocouples
- Single pair of PTFE insulated conductors twisted together
- Good mechanical strength and flexibility, resistant to oils, acids and other adverse fluids
- Suitable for steam & pressure applications, autoclaves, sterilizers etc.
- 25 & 50 metre reel lengths
- Tolerance Class 1 for optimum accuracy
- Insulation rating -75°C to 260°C
- Colour coded to IEC-584-3

T/C Type	Conductors	Cores	Reel Length	Allied code	RS order code
J	1/0.2mm	+Black/-White	25 metres	70657194	827-5980
J	1/0.2mm	+Black/-White	50 metres	70657195	827-5984
J	1/0.315mm	+Black/-White	25 metres	70657198	827-5993
J	1/0.315mm	+Black/-White	50 metres	70657199	827-5996
K	1/0.315mm	+Green/-White	25 metres	70657200	827-6000
K	1/0.315mm	+Green/-White	50 metres	70657205	827-6019
T	1/0.315mm	+Brown/-White	25 metres	70657208	827-6028
T	1/0.315mm	+Brown/-White	50 metres	70657206	827-6022
J	1/0.508mm	+Black/-White	25 metres	70657197	827-5990
J	1/0.508mm	+Black/-White	50 metres	70657201	827-6003
K	1/0.508mm	+Green/-White	25 metres	70657203	827-6012
K	1/0.508mm	+Green/-White	50 metres	70657204	827-6016
J	7/0.2mm	+Black/-White	25 metres	70657202	827-6006
K	7/0.2mm	+Green/-White	25 metres	70657207	827-6025
T	7/0.2mm	+Brown/-White	25 metres	70657209	827-6031
N	7/0.2mm	+Pink/-White	25 metres	70657210	827-6034

IEC PVC Insulated Flat Pair Thermocouple Extension & Compensating Cable

PVC Insulated Flat Pair (to IEC-584)

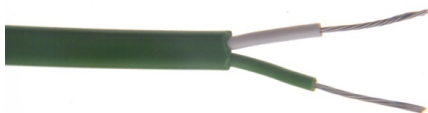

- PVC insulated flat pair construction
- Conductors laid flat PVC insulated with overall PVC sheath
- All round general purpose cable, both waterproof and very flexible
- Thermocouple extension types for K, J, T & N

- Compensating types VX (KCB) & U (RCA) for types K & R/S Thermocouples respectively
- Stranded conductors available, either 7/0.2mm or 13/0.2mm
- Available in 10, 25, 100 & 200 metre lengths
- Tolerance Class 2
- Insulation rating -10°C to 105°C
- Colour code (cores & jacket) to IEC-584-3

	Conductors	Cores	Jacket	Reel Length	Allied Code	RS order code
Extension:						
KX	7/0.2mm	+Green/-White	Green	10 metres	70657084	827-5615
KX	7/0.2mm	+Green/-White	Green	25 metres	70641729	236-3820
KX	7/0.2mm	+Green/-White	Green	50 metres	70657085	827-5619
KX	7/0.2mm	+Green/-White	Green	100 metres	70646156	611-7889
KX	7/0.2mm	+Green/-White	Green	200 metres	70657088	827-5628
JX	7/0.2mm	+Black/-White	Black	10 metres	70641640	219-4753
JX	7/0.2mm	+Black/-White	Black	25 metres	70657078	827-5592
JX	7/0.2mm	+Black/-White	Black	50 metres	70657079	827-5596
JX	7/0.2mm	+Black/-White	Black	100 metres	70641737	236-3915
JX	7/0.2mm	+Black/-White	Black	200 metres	70657081	827-5606
TX	7/0.2mm	+Brown/-White	Brown	10 metres	70641637	219-4703
TX	7/0.2mm	+Brown/-White	Brown	25 metres	70641734	236-3870
TX	7/0.2mm	+Brown/-White	Brown	50 metres	70657095	827-5653
TX	7/0.2mm	+Brown/-White	Brown	100 metres	70651749	762-1146
TX	7/0.2mm	+Brown/-White	Brown	200 metres	70657098	827-5662
NX	7/0.2mm	+Pink/-White	Pink	10 metres	70641635	219-4668
NX	7/0.2mm	+Pink/-White	Pink	25 metres	70657091	827-5637
NX	7/0.2mm	+Pink/-White	Pink	50 metres	70657089	827-5631
NX	7/0.2mm	+Pink/-White	Pink	100 metres	70657092	827-5640
	Conductors	Cores	Jacket	Reel Length	Allied Code	RS order code
Compensating:						
VX (KCB)	7/0.2mm	+Green/-White	Green	10 metres	70657082	827-5609
VX (KCB)	7/0.2mm	+Green/-White	Green	25 metres	70641629	219-4551
VX (KCB)	7/0.2mm	+Green/-White	Green	50 metres	70657080	827-5603
VX (KCB)	7/0.2mm	+Green/-White	Green	100 metres	70641630	219-4573
VX (KCB)	7/0.2mm	+Green/-White	Green	200 metres	70657083	827-5612
VX (KCB)	13/0.2mm	+Green/-White	Green	10 metres	70657086	827-5621
VX (KCB)	13/0.2mm	+Green/-White	Green	25 metres	70657087	827-5625
VX (KCB)	13/0.2mm	+Green/-White	Green	50 metres	70657090	827-5634
VX (KCB)	13/0.2mm	+Green/-White	Green	100 metres	70651750	762-1152
U (RCA)	7/0.2mm	+Orange/-White	Orange	10 metres	70657096	827-5656
U (RCA)	7/0.2mm	+Orange/-White	Orange	25 metres	70646158	611-7902
U (RCA)	7/0.2mm	+Orange/-White	Orange	50 metres	70657097	827-5659
U (RCA)	13/0.2mm	+Orange/-White	Orange	10 metres	70641641	219-4769
U (RCA)	13/0.2mm	+Orange/-White	Orange	25 metres	70657093	827-5643
U (RCA)	13/0.2mm	+Orange/-White	Orange	50 metres	70657094	827-5647

RS154/0816

IEC PTFE Single Shot Thermocouple Cable

Type K, 10 metre reel



- Thermocouple type K
- 10 metre spool length
- 7/0.2mm diameter conductor
- Operating range: -75°C to +250°C
- Teflon insulated single shot construction
- Resistant to chemicals, oils and fluids
- Suitable for aerospace applications and is widely used in autoclaves
- Colour coded to IEC-584-3

Type	Outer	Length	Allied code	RS Code
K	Green/White	10 metres	70657216	827-6053

ANSI PFA Insulated Twin Twisted Pair Thermocouple Cable

Available in Thermocouple Types K & T (ANSI MC96.1)

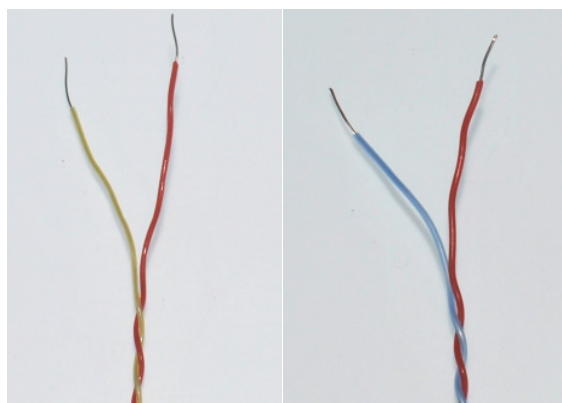

Type KX

Type TX

- PFA Teflon® twin twisted pair for extending or making simple thermocouples
- Single pair of PFA insulated conductors twisted together
- Good mechanical strength and flexibility, resistant to oils, acids and other adverse fluids, gasses, steam etc.
- Thermocouple types K & T with 1/0.2mm OR 1/0.3 conductors. 7/0.2mm option available for type K
- 25, 50 & 100 metre reel lengths
- Tolerance Class 1 for optimum accuracy

RS154/0816

- Insulation rating -75°C to 260°C
- Colour coded to ANSI MC96.1

T/C Type	Conductors	Cores	Reel Length	Allied code	RS order code
KX	1/0.2mm	+Yellow/-Red	25 metres	70656106	814-0030
KX	1/0.2mm	+Yellow/-Red	50 metres	70656111	814-0049
KX	1/0.2mm	+Yellow/-Red	100 metres	70656109	814-0042
KX	7/0.2mm	+Yellow/-Red	25 metres	70656110	814-0046
KX	7/0.2mm	+Yellow/-Red	50 metres	70656113	814-0055
KX	7/0.2mm	+Yellow/-Red	100 metres	70656114	814-0058
KX	1/0.3mm	+Yellow/-Red	25 metres	70656104	814-0024
KX	1/0.3mm	+Yellow/-Red	50 metres	70656107	814-0033
KX	1/0.3mm	+Yellow/-Red	100 metres	70656108	814-0036
TX	1/0.3mm	+Blue/-Red	25 metres	70656121	814-0080
TX	1/0.3mm	+Blue/-Red	50 metres	70656126	814-0099
TX	1/0.3mm	+Blue/-Red	100 metres	70656124	814-0092
TX	1/0.2mm	+Blue/-Red	25 metres	70656125	814-0096
TX	1/0.2mm	+Blue/-Red	50 metres	70656128	814-0106
TX	1/0.2mm	+Blue/-Red	100 metres	70656129	814-0109

ANSI PVC Thermocouple Extension & Compensating Cable

PVC Insulated Flat Pair (ANSI MC96.1)

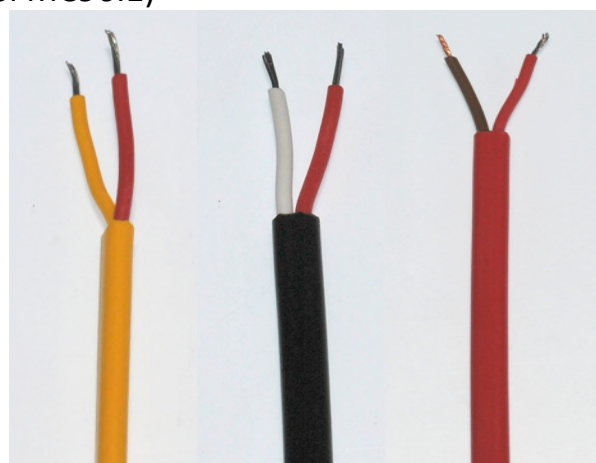

Type KX

Type JX

Type TX

- PVC insulated flat pair construction
- Conductors laid flat PVC insulated with overall PVC sheath
- All round general purpose cable, both waterproof and very flexible
- Thermocouple extension types for K, J, & T
- Compensating types VX (KCB) for types K Thermocouples

- Stranded conductors available, 7/0.2mm
- Available in 25, 100 & 200 metre lengths
- Tolerance Class 2
- Insulation rating -10°C to 105°C
- Colour code (cores & jacket) to ANSI MC96.1

T/C Type	Conductors	Cores	Jacket	Reel Length	Allied code	RS order code
Extension:						
KX	7/0.2mm	+Yellow/-Red	Yellow	25 m	70656102	814-0018
KX	7/0.2mm	+Yellow/-Red	Yellow	100 m	70656105	814-0027
KX	7/0.2mm	+Yellow/-Red	Yellow	200 m	70656103	814-0020
JX	7/0.2mm	+ White/-Red	Black	25 m	70656096	813-9995
JX	7/0.2mm	+ White/-Red	Black	100 m	70656098	814-0005
JX	7/0.2mm	+ White/-Red	Black	200 m	70656099	814-0008
TX	7/0.2mm	+Blue/-Red	Blue	25 m	70656119	814-0074
TX	7/0.2mm	+Blue/-Red	Blue	100 m	70656122	814-0083
TX	7/0.2mm	+Blue/-Red	Blue	200 m	70656123	814-0086
Compensating:						
VX (KCB)	7/0.2mm	+Yellow/-Red	Yellow	25 m	70656127	814-0103
VX (KCB)	7/0.2mm	+Yellow/-Red	Yellow	100 m	70656130	814-0112
VX (KCB)	7/0.2mm	+Yellow/-Red	Yellow	200 m	70656131	814-0115