

Base strip - MDSTBV 2,5/ 2-GFL-5,08 - 1836477

Please be informed that the data shown in this PDF Document is generated from our Online Catalog. Please find the complete data in the user's documentation. Our General Terms of Use for Downloads are valid (<http://phoenixcontact.com/download>)

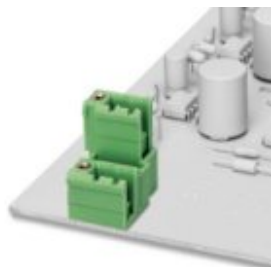

Header, Nominal current: 10 A, Rated voltage (III/2): 320 V, Number of positions: 2, Pitch: 5.08 mm, Color: green, Contact surface: Tin, Mounting: Soldering, The article can be aligned to create different nos. of positions! In combination with MVSTB or FKCV plug components, both an MVSTBW (or FKCVW) and an MVSTBR plug (or FKCVR) must be used. Combination with TMSTBP plug components is not possible!



Key commercial data

Packing unit	50 pc
GTIN	 4 017918 121563
Weight per Piece (excluding packing)	4.85 g
Custom tariff number	85366990
Country of origin	Germany

Technical data

Dimensions

Length	28.5 mm
Pitch	5.08 mm
Dimension a	5.08 mm
Pin dimensions	1 x 1 mm
Hole diameter	1.4 mm

General

Range of articles	MDSTBV 2,5/..-GF
Insulating material group	III
Rated surge voltage (III/3)	4 kV
Rated surge voltage (III/2)	4 kV
Rated surge voltage (II/2)	4 kV
Rated voltage (III/3)	250 V
Rated voltage (III/2)	320 V
Rated voltage (II/2)	400 V
Connection in acc. with standard	EN-VDE
Nominal current I_N	10 A

Base strip - MDSTBV 2,5/ 2-GFL-5,08 - 1836477

Technical data

General

Maximum load current	10 A
Insulating material	PBT
Color	green
Number of positions	2

Classifications

eCl@ss

eCl@ss 4.0	272607xx
eCl@ss 4.1	27260701
eCl@ss 5.0	27260701
eCl@ss 5.1	27260701
eCl@ss 6.0	27260704
eCl@ss 7.0	27440402
eCl@ss 8.0	27440402

ETIM

ETIM 3.0	EC001121
ETIM 4.0	EC002637
ETIM 5.0	EC002637

UNSPSC

UNSPSC 6.01	30211810
UNSPSC 7.0901	39121409
UNSPSC 11	39121409
UNSPSC 12.01	39121409
UNSPSC 13.2	39121409

Approvals

Approvals

Approvals

UL Recognized / VDE Gutachten mit Fertigungsüberwachung / cUL Recognized / GL / IECCEB Scheme / CCA / EAC / cULus Recognized

Ex Approvals

Approvals submitted

Base strip - MDSTBV 2,5/ 2-GFL-5,08 - 1836477

Approvals

Approval details

UL Recognized 		
	B	D
Nominal current IN	12 A	10 A
Nominal voltage UN	300 V	300 V

VDE Gutachten mit Fertigungsüberwachung 	
Nominal current IN	10 A
Nominal voltage UN	250 V

cUL Recognized 		
	B	D
Nominal current IN	12 A	10 A
Nominal voltage UN	300 V	300 V

GL	
Nominal current IN	8 A
Nominal voltage UN	250 V

IECEE CB Scheme 	
Nominal current IN	10 A
Nominal voltage UN	250 V

CCA	
Nominal current IN	10 A
Nominal voltage UN	250 V

EAC	
-----	--

Base strip - MDSTBV 2,5/ 2-GFL-5,08 - 1836477

Approvals

cULus Recognized us

Drawings

Drilling diagram

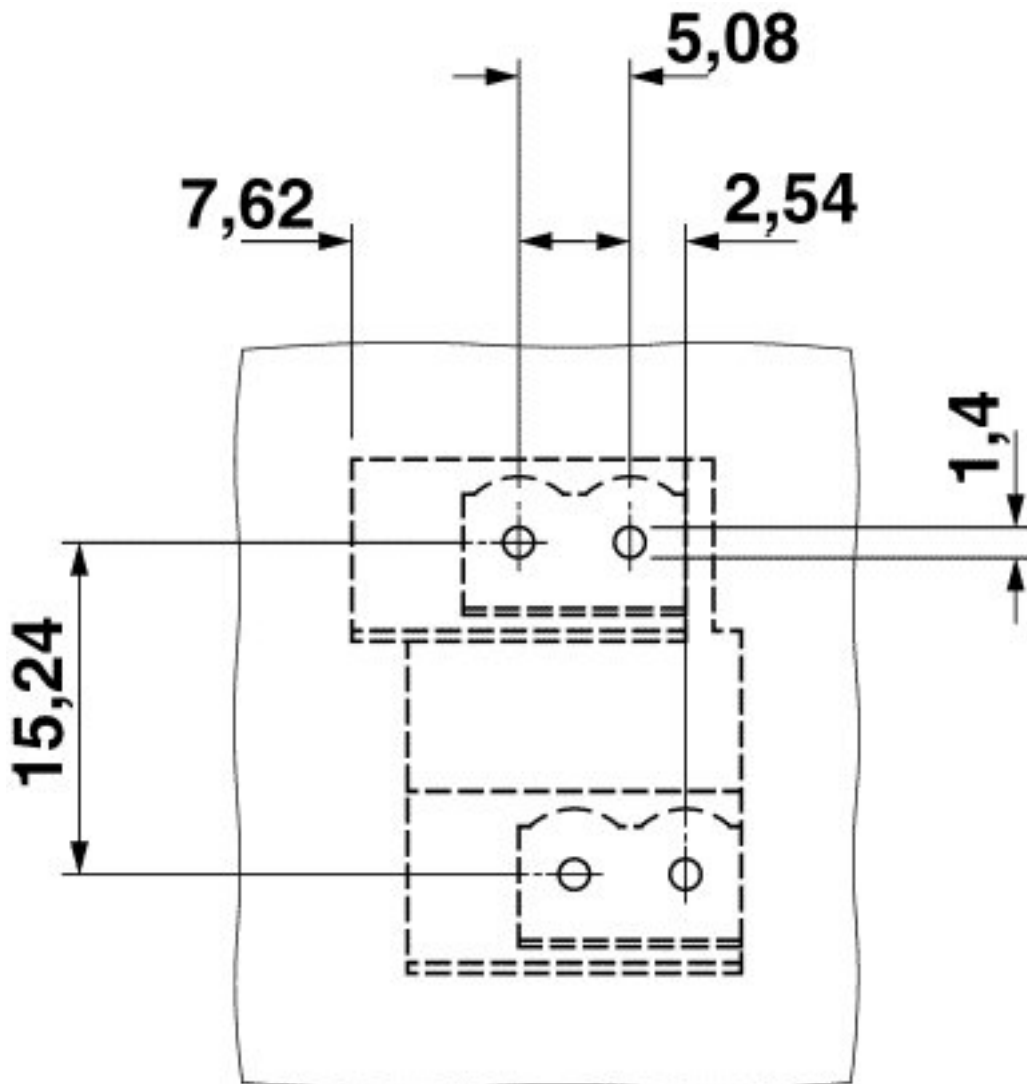

Base strip - MDSTBV 2,5/ 2-GFL-5,08 - 1836477

Dimensioned drawing

