

T110, Tantalum, MnO2 Tantalum, Commercial Grade, 33 uF, 10%, 10 VDC, 2.1 Ohms

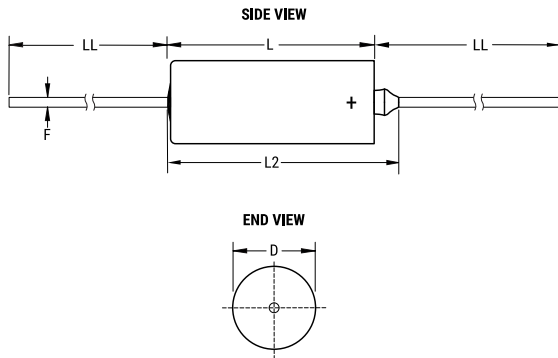

Dimensions	
D	4.7mm +/-0.25mm
L	12.04mm +/-0.79mm
L2	15.49mm
LL	38.1mm +/-6.35mm
F	0.51mm +/-0.05mm

Packaging Specifications	
Packaging:	Bulk, Box
Packaging Quantity:	75

General Information	
Supplier:	KEMET
Series:	T110
Dielectric:	MnO2 Tantalum
Style:	Axial Hermetic
Description:	Axial, Solid Tantalum, Hermetically Sealed, Military (Non-ER), Polar
Features:	Polar
RoHS:	Yes
Termination:	Tin
Lead:	Wire Leads
Construction:	Hermetic
Notes:	Dimensions Include Insulation Sleeve. When Supplied On T&R Or Ammo, Lead Length Is Determined By Taping Specification

Specifications	
Capacitance:	33 uF
Capacitance Tolerance:	10%
Voltage DC:	10 VDC (85C), 9 VDC (125C Surge), 0.1 VDC (125C Reverse)
Temperature Range:	-55/+125C
Rated Temperature:	85°C
Resistance:	2.1 Ohms (100kHz)
Leakage Current:	2 uA (25C)