

Optocoupler, Phototransistor Output, High Reliability, 5300 V_{RMS}

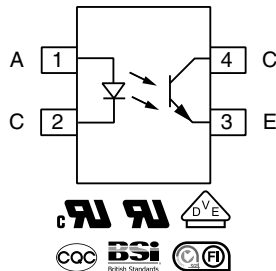

FEATURES

- Operating temperature from - 55 °C to + 110 °C
- Good CTR linearity depending on forward current
- Isolation test voltage, 5300 V_{RMS}
- High collector emitter voltage, V_{CEO} = 80 V
- Low saturation voltage
- Fast switching times
- Low CTR degradation
- Temperature stable
- Low coupling capacitance
- End stackable, 0.100" (2.54 mm) spacing
- High common mode interference immunity
- Material categorization: For definitions of compliance please see www.vishay.com/doc?99912

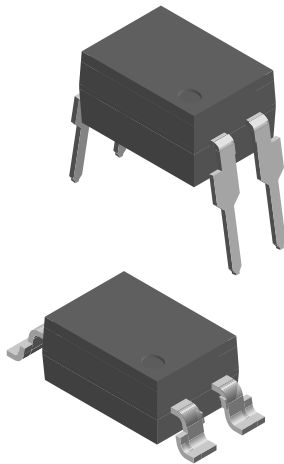

DESCRIPTION

The 110 °C rated VO617A feature a high current transfer ratio, low coupling capacitance and high isolation voltage. These couplers have a GaAs infrared diode emitter, which is optically coupled to a silicon planar phototransistor detector, and is incorporated in a plastic DIP-4 package.

The coupling devices are designed for signal transmission between two electrically separated circuits.

The couplers are end-stackable with 2.54 mm spacing.

Creepage and clearance distances of > 8.0 mm are achieved with option 6. This version complies with IEC 60950 (DIN VDE 0805) for reinforced insulation up to an operation voltage of 400 V_{RMS} or DC. Specifications subject to change.

APPLICATIONS

- AC adapters
- SMPS
- PLC
- Factory automation
- Game consoles

AGENCY APPROVALS

- UL1577, file no. E52744
- cUL tested to CSA 22.2 bulletin 5A
- DIN EN 60747-5-5 (VDE 0884-5), available with option 1
- BSI IEC 60950; IEC 60065
- FIMKO EN 60065, EN 60950-1
- CQC GB8898-2001

ORDERING INFORMATION

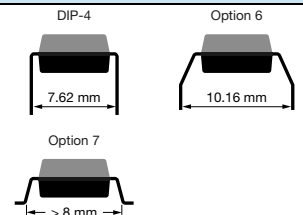
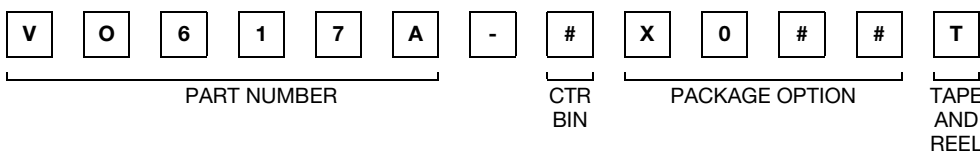

| AGENCY CERTIFIED/PACKAGE | CTR (%) | | | | | | |
|--------------------------|-----------|----------|---------------|---------------|---------------|---------------|---------------|
| | 5 mA | | | | | | |
| UL, cUL, BSI, FIMKO | 50 to 600 | 40 to 80 | 63 to 125 | 100 to 200 | 160 to 320 | 80 to 160 | 130 to 260 |
| DIP-4 | VO617A | VO617A-1 | VO617A-2 | VO617A-3 | VO617A-4 | - | - |
| DIP-4, 400 mil, option 6 | - | - | - | VO617A-3X006 | VO617A-4X006 | - | - |
| SMD-4, option 7 | - | - | VO617A-2X007T | VO617A-3X007T | VO617A-4X007T | - | - |
| VDE, UL, cUL, BSI, FIMKO | 50 to 600 | 40 to 80 | 63 to 125 | 100 to 200 | 160 to 320 | 80 to 160 | 130 to 260 |
| DIP-4, 400 mil, option 6 | - | - | - | VO617A-3X016 | VO617A-4X016 | - | - |
| SMD-4, option 7 | - | - | VO617A-2X017T | VO617A-3X017T | VO617A-4X017T | VO617A-7X017T | VO617A-8X017T |

Note

- Additional options may be possible, please contact sales office.

| ABSOLUTE MAXIMUM RATINGS ($T_{amb} = 25\text{ }^{\circ}\text{C}$, unless otherwise specified) | | | | |
|--|--------------------------------------|------------|---------------|--------------------|
| PARAMETER | TEST CONDITION | SYMBOL | VALUE | UNIT |
| INPUT | | | | |
| Reverse voltage | | V_R | 6 | V |
| Forward current | | I_F | 60 | mA |
| Forward surge current | $t_p \leq 10\text{ }\mu\text{s}$ | I_{FSM} | 2.5 | A |
| LED power dissipation | at $25\text{ }^{\circ}\text{C}$ | P_{diss} | 70 | mW |
| OUTPUT | | | | |
| Collector emitter voltage | | V_{CEO} | 80 | V |
| Emitter collector voltage | | V_{ECO} | 7 | V |
| Collector current | | I_C | 50 | mA |
| Collector peak current | $t_p/T = 0.5, t_p \leq 10\text{ ms}$ | I_{CM} | 100 | mA |
| Output power dissipation | at $25\text{ }^{\circ}\text{C}$ | P_{diss} | 150 | mW |
| COUPLER | | | | |
| Isolation test voltage (RMS) | $t = 1\text{ min}$ | V_{ISO} | 5300 | V_{RMS} |
| Total power dissipation | | P_{tot} | 200 | mW |
| Operation temperature | | T_{amb} | - 55 to + 110 | $^{\circ}\text{C}$ |
| Storage temperature range | | T_{stg} | - 55 to + 150 | $^{\circ}\text{C}$ |
| Soldering temperature ⁽¹⁾ | 2 mm from case, $\leq 10\text{ s}$ | T_{sld} | 260 | $^{\circ}\text{C}$ |

Notes

- Stresses in excess of the absolute maximum ratings can cause permanent damage to the device. Functional operation of the device is not implied at these or any other conditions in excess of those given in the operational sections of this document. Exposure to absolute maximum ratings for extended periods of the time can adversely affect reliability.

⁽¹⁾ Refer to reflow profile for soldering conditions for surface mounted devices (SMD), and wave profile for soldering conditions for through hole devices (DIP), please go to "Assembly Instructions" (www.vishay.com/doc?80054).

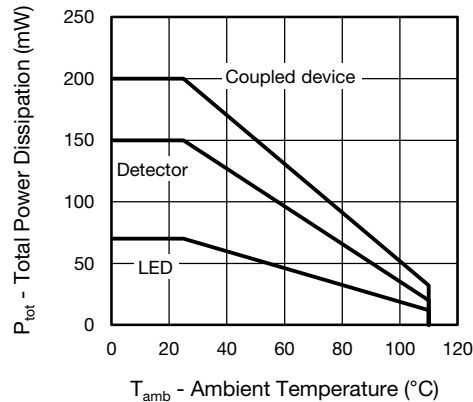

Fig. 1 - Total Power Dissipation vs. Ambient Temperature



| ELECTRICAL CHARACTERISTICS ($T_{amb} = 25\text{ }^{\circ}\text{C}$, unless otherwise specified) | | | | | | | |
|--|---|----------|-------------|------|------|------|---------------|
| PARAMETER | TEST CONDITION | PART | SYMBOL | MIN. | TYP. | MAX. | UNIT |
| INPUT | | | | | | | |
| Forward voltage | $I_F = 60\text{ mA}$ | | V_F | 1 | 1.35 | 1.65 | V |
| Reverse current | $V_R = 6\text{ V}$ | | I_R | | 0.01 | 10 | μA |
| Junction capacitance | $V_R = 0\text{ V}$, $f = 1\text{ MHz}$ | | C_j | | 13 | | pF |
| OUTPUT | | | | | | | |
| Collector emitter leakage current | $V_{CE} = 10\text{ V}$ | VO617A-1 | I_{CEO} | | 2 | 50 | nA |
| | | VO617A-2 | | | 2 | 50 | |
| | | VO617A-3 | | | 5 | 100 | |
| | | VO617A-4 | | | 5 | 100 | |
| | | VO617A-7 | | | 5 | 100 | |
| | | VO617A-8 | | | 5 | 100 | |
| Collector emitter capacitance | $V_{CE} = 5\text{ V}$, $f = 1\text{ MHz}$ | | C_{CE} | | 5.2 | | pF |
| Collector emitter breakdown voltage | $I_C = 1\text{ mA}$ | | BV_{CEO} | 80 | | | V |
| Emitter collector breakdown voltage | $I_E = 100\text{ }\mu\text{A}$ | | BV_{ECO} | 7 | | | V |
| COUPLER | | | | | | | |
| Collector emitter saturation voltage | $I_F = 5\text{ mA}$, $I_C = 1.0\text{ mA}$ | | V_{CEsat} | | 0.25 | 0.4 | V |
| Coupling capacitance | $f = 1\text{ MHz}$ | | C_C | | 0.4 | | pF |

Note

- Minimum and maximum values are testing requirements. Typical values are characteristics of the device and are the result of engineering evaluation. Typical values are for information only and are not part of the testing requirements.

| CURRENT TRANSFER RATIO ($T_{amb} = 25\text{ }^{\circ}\text{C}$, unless otherwise specified) | | | | | | | |
|--|---|----------|--------|------|------|------|------|
| PARAMETER | TEST CONDITION | PART | SYMBOL | MIN. | TYP. | MAX. | UNIT |
| I_C/I_F | $I_F = 5\text{ mA}$, $V_{CE} = 5\text{ V}$ | VO617A | CTR | 50 | | 600 | % |
| | | VO617A-1 | CTR | 40 | | 80 | % |
| | | VO617A-2 | CTR | 63 | | 125 | % |
| | | VO617A-3 | CTR | 100 | | 200 | % |
| | | VO617A-4 | CTR | 160 | | 320 | % |
| | | VO617A-7 | CTR | 80 | | 160 | % |
| | | VO617A-8 | CTR | 130 | | 260 | % |

| SWITCHING CHARACTERISTICS ($T_{amb} = 25\text{ }^{\circ}\text{C}$, unless otherwise specified) | | | | | | | |
|---|--|---------|---------------|------|------|------|---------------|
| PARAMETER | TEST CONDITION | CTR BIN | SYMBOL | MIN. | TYP. | MAX. | UNIT |
| NON-SATURATED | | | | | | | |
| Rise and fall time | $I_F = 5\text{ mA}$, $V_{CC} = 5\text{ V}$, $R_L = 75\text{ }\Omega$ | | t_r , t_f | | 2 | | μs |
| Turn-on time | $I_F = 5\text{ mA}$, $V_{CC} = 5\text{ V}$, $R_L = 75\text{ }\Omega$ | | t_{on} | | 3 | | μs |
| Turn-off time | | | t_{off} | | 2.3 | | μs |
| Cut-off frequency | $I_F = 5\text{ mA}$, $V_{CC} = 5\text{ V}$, $R_L = 75\text{ }\Omega$ | | f_{ctr} | | 100 | | kHz |
| SATURATED | | | | | | | |
| Turn-on time | $I_F = 5\text{ mA}$ | | t_{on} | | 6 | | μs |
| Turn-off time | $I_F = 5\text{ mA}$ | | t_{off} | | 25 | | μs |
| Rise time | $I_F = 5\text{ mA}$ | | t_r | | 4.6 | | μs |
| Fall time | $I_F = 5\text{ mA}$ | | t_f | | 15 | | μs |

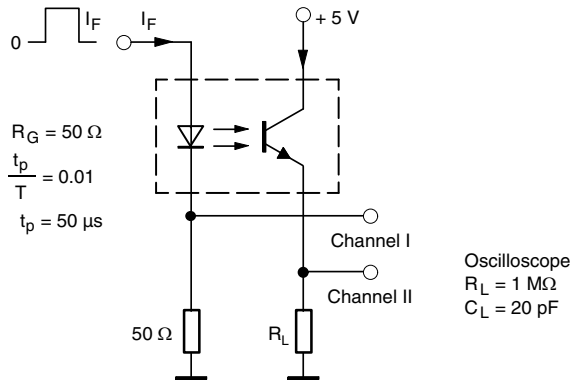

95 10804-3

Fig. 2 - Test Circuit, Non-Saturated Operation

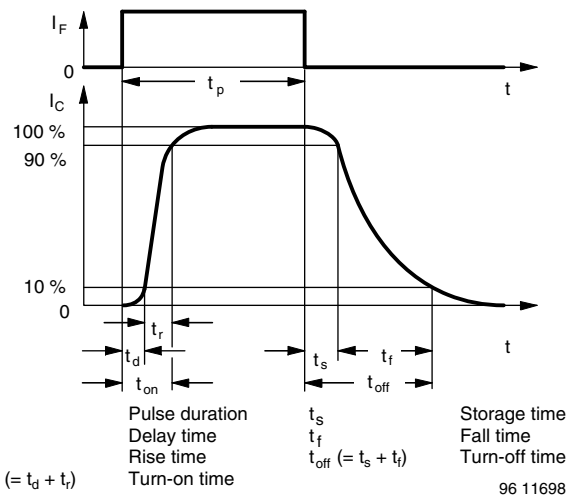
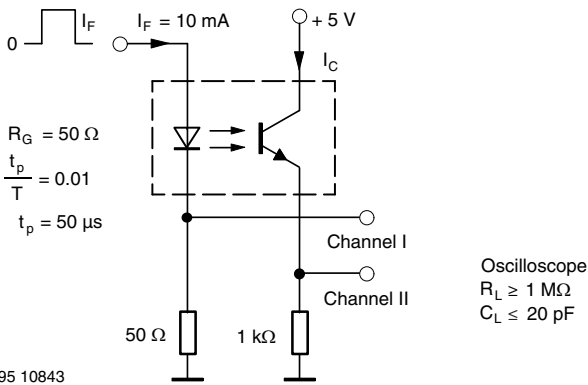

Fig. 4 - Switching Times



95 10843

Fig. 3 - Test Circuit, Saturated Operation

| SAFETY AND INSULATION RATINGS | | | | |
|--|--|------------|-----------|------------|
| PARAMETER | | SYMBOL | VALUE | UNIT |
| MAXIMUM SAFETY RATINGS | | | | |
| Output safety power | | P_{SO} | 265 | mW |
| Input safety current | | I_{SI} | 130 | mA |
| Safety temperature | | T_S | 150 | °C |
| Comparative tracking index | | CTI | 175 | |
| INSULATION RATED PARAMETERS | | | | |
| Maximum withstanding isolation voltage | | V_{ISO} | 5300 | V_{RMS} |
| Maximum transient isolation voltage | | V_{IOTM} | 8000 | V_{peak} |
| Maximum repetitive peak isolation voltage | | V_{IORM} | 890 | V_{peak} |
| Insulation resistance | $T_{amb} = 25\text{ °C}, V_{DC} = 500\text{ V}$ | R_{IO} | 10^{12} | Ω |
| Insulation resistance | $T_{amb} = 100\text{ °C}, V_{DC} = 500\text{ V}$ | R_{IO} | 10^{11} | Ω |
| Climatic classification (according to IEC 68 part 1) | | | 55/110/21 | |
| Environment (pollution degree in accordance to DIN VDE 0109) | | | 2 | |
| Internal and external creepage | Standard DIP-4 | | ≥ 7 | mm |
| | 400 mil DIP-4 | | ≥ 8 | mm |
| Clearance | Standard DIP-4 | | ≥ 7 | mm |
| | 400 mil DIP-4 | | ≥ 8 | mm |
| Insulation thickness | | | 0.4 | mm |

Note

- As per DIN EN 60747-5-5, § 7.4.3.8.2, this optocoupler is suitable for “safe electrical insulation” only within the safety ratings. Compliance with the safety ratings shall be ensured by means of protective circuits.

TYPICAL CHARACTERISTICS ($T_{amb} = 25\text{ }^{\circ}\text{C}$, unless otherwise specified)

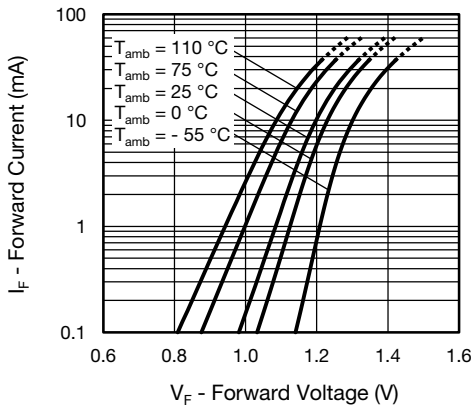

Fig. 5 - Forward Voltage vs. Forward Current

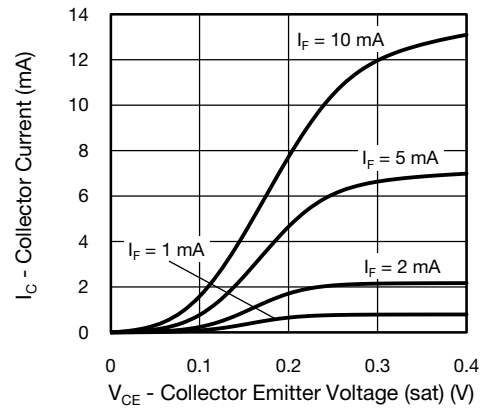

Fig. 8 - Collector Current vs. Collector Emitter Voltage (sat)

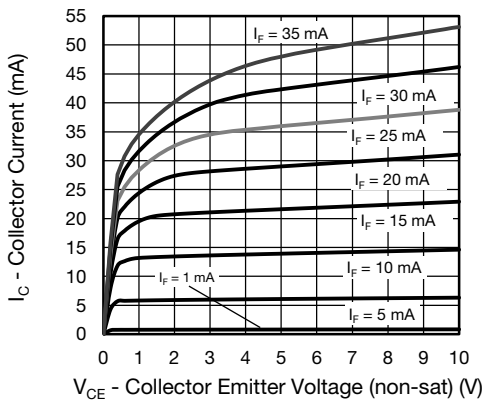

Fig. 6 - Collector Current vs. Collector Emitter Voltage (NS)

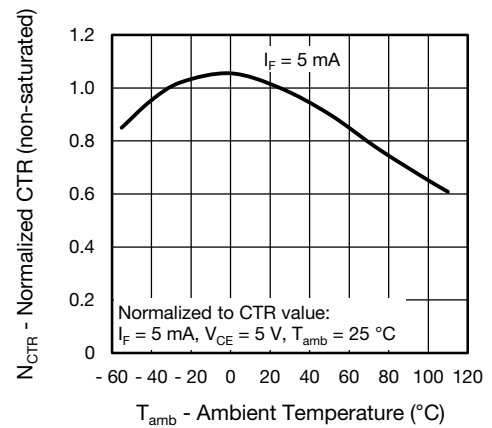

Fig. 9 - Normalized Current Transfer Ratio (non-sat) vs. Ambient Temperature

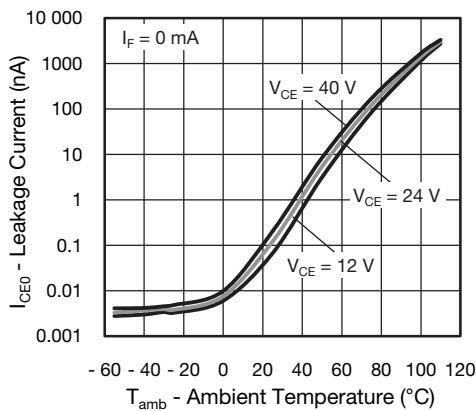

Fig. 7 - Leakage Current vs. Ambient Temperature

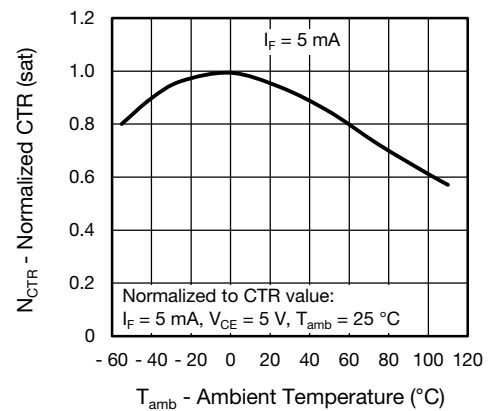

Fig. 10 - Normalized Current Transfer Ratio (sat) vs. Ambient Temperature

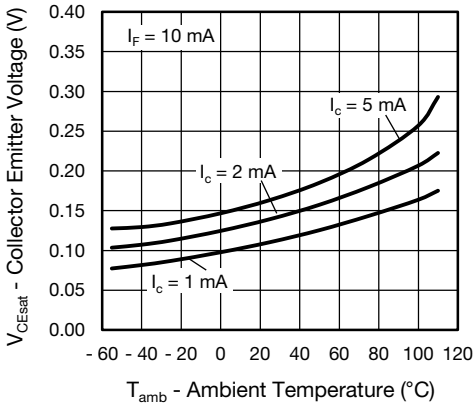

Fig. 11 - Collector Emitter Voltage vs. Ambient Temperature (saturated)

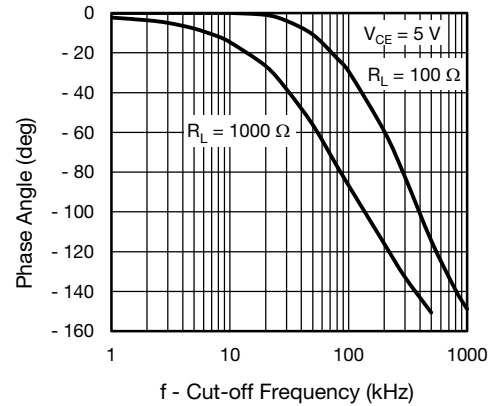

Fig. 14 - F_{CTR} vs. Phase Angle

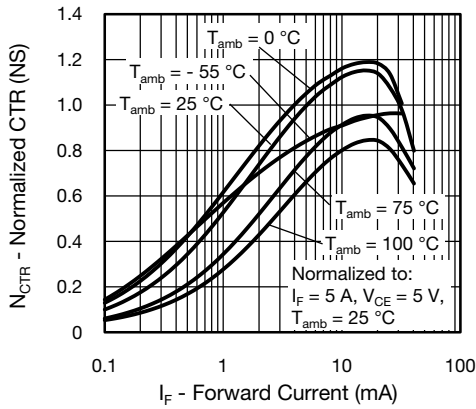

Fig. 12 - Normalized CTR (NS) vs. Forward Current

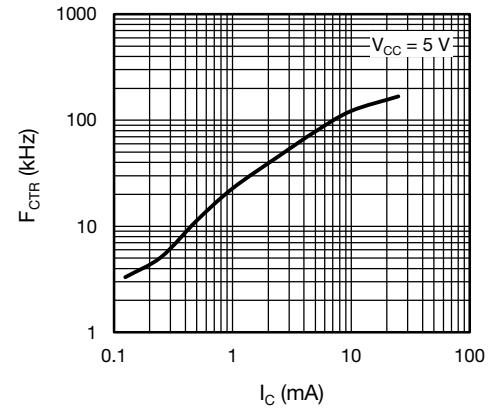

Fig. 15 - F_{CTR} vs. Collector Current

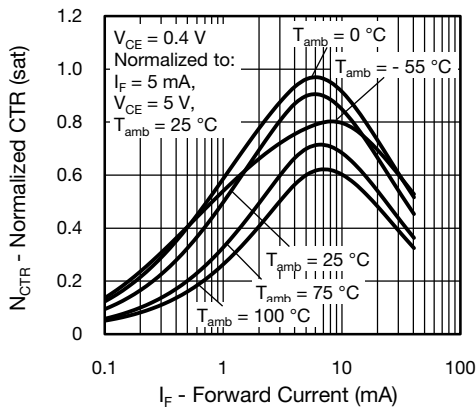

Fig. 13 - Normalized CTR (sat) vs. Forward Current

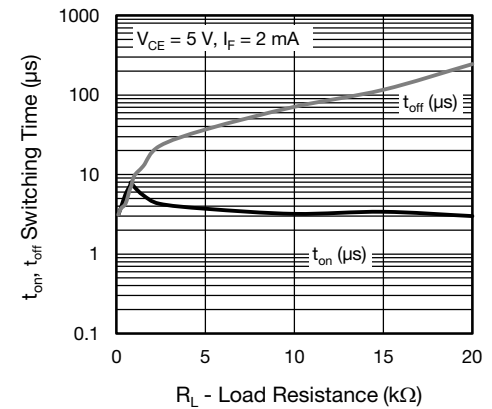
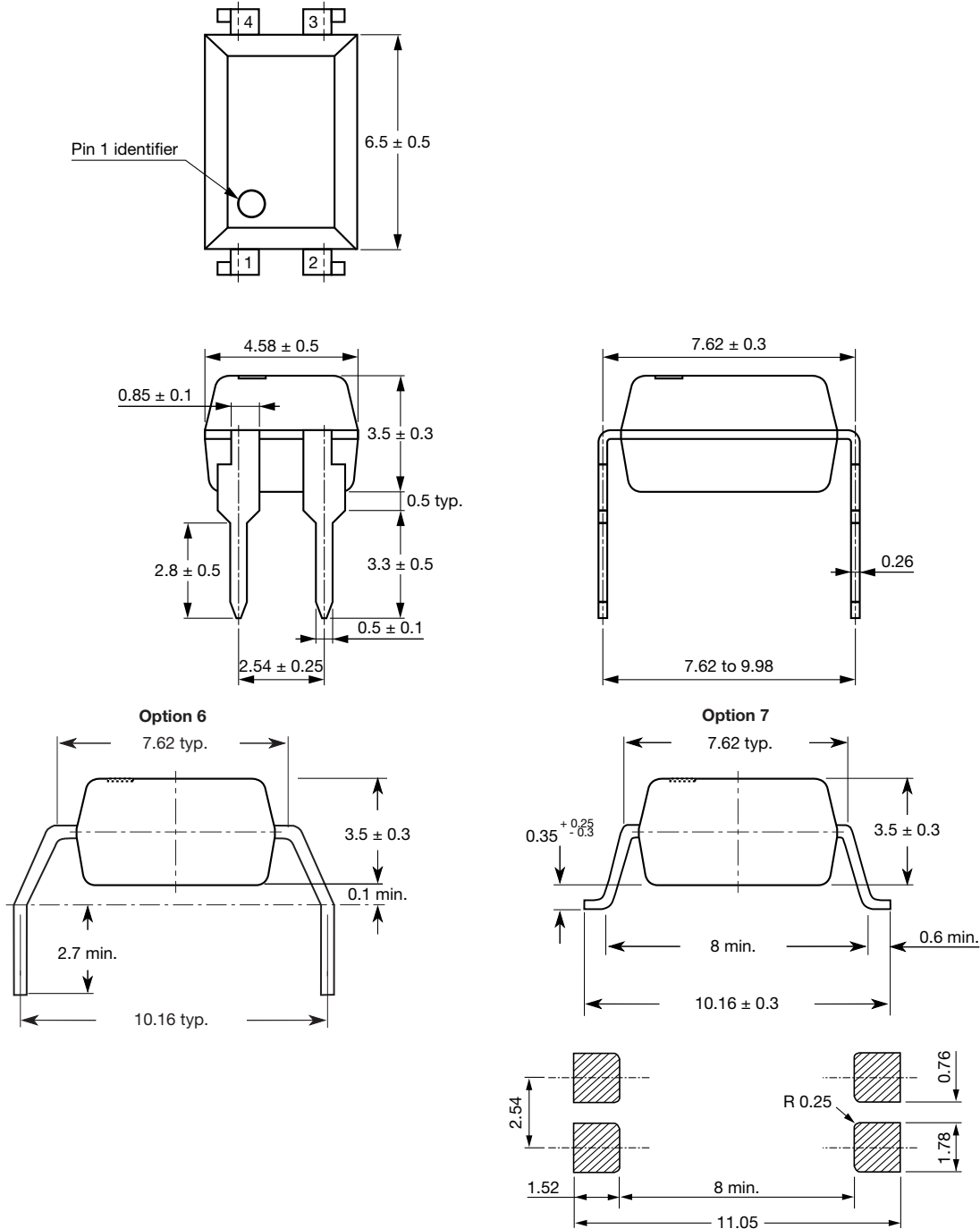
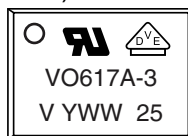

Fig. 16 - Switching Time vs. Load Resistance

PACKAGE DIMENSIONS in millimeters



PACKAGE MARKING (example of VO617A-3X017T)



Notes

- The VDE logo is only marked on option 1 parts. Option information is not marked on the part.
- Tape and reel suffix (T) is not part of the package marking.

PACKING INFORMATION

| DEVICE PER TUBE | | | |
|-----------------|------------|-----------|-----------|
| TYPE | UNITS/TUBE | TUBES/BOX | UNITS/BOX |
| DIP-4 | 100 | 40 | 4000 |

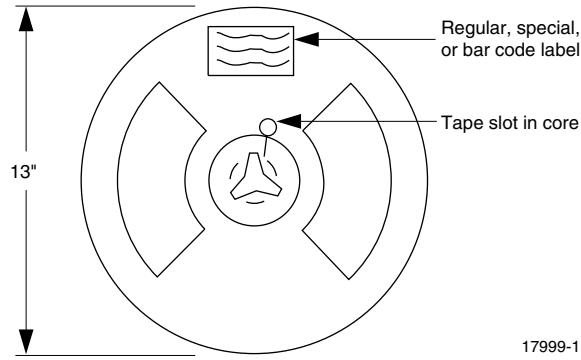

Fig. 17 - Tape and Reel Shipping Medium (1000 units per reel)

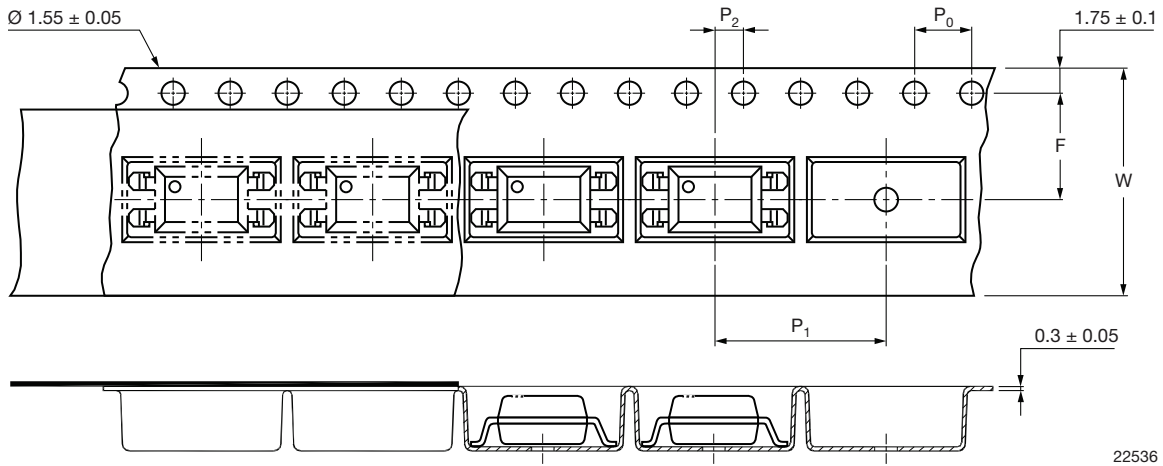

Fig. 18 - Tape and Packing for Option 7



Disclaimer

ALL PRODUCT, PRODUCT SPECIFICATIONS AND DATA ARE SUBJECT TO CHANGE WITHOUT NOTICE TO IMPROVE RELIABILITY, FUNCTION OR DESIGN OR OTHERWISE.

Vishay Intertechnology, Inc., its affiliates, agents, and employees, and all persons acting on its or their behalf (collectively, "Vishay"), disclaim any and all liability for any errors, inaccuracies or incompleteness contained in any datasheet or in any other disclosure relating to any product.

Vishay makes no warranty, representation or guarantee regarding the suitability of the products for any particular purpose or the continuing production of any product. To the maximum extent permitted by applicable law, Vishay disclaims (i) any and all liability arising out of the application or use of any product, (ii) any and all liability, including without limitation special, consequential or incidental damages, and (iii) any and all implied warranties, including warranties of fitness for particular purpose, non-infringement and merchantability.

Statements regarding the suitability of products for certain types of applications are based on Vishay's knowledge of typical requirements that are often placed on Vishay products in generic applications. Such statements are not binding statements about the suitability of products for a particular application. It is the customer's responsibility to validate that a particular product with the properties described in the product specification is suitable for use in a particular application. Parameters provided in datasheets and/or specifications may vary in different applications and performance may vary over time. All operating parameters, including typical parameters, must be validated for each customer application by the customer's technical experts. Product specifications do not expand or otherwise modify Vishay's terms and conditions of purchase, including but not limited to the warranty expressed therein.

Except as expressly indicated in writing, Vishay products are not designed for use in medical, life-saving, or life-sustaining applications or for any other application in which the failure of the Vishay product could result in personal injury or death. Customers using or selling Vishay products not expressly indicated for use in such applications do so at their own risk and agree to fully indemnify and hold Vishay and its distributors harmless from and against any and all claims, liabilities, expenses and damages arising or resulting in connection with such use or sale, including attorneys fees, even if such claim alleges that Vishay or its distributor was negligent regarding the design or manufacture of the part. Please contact authorized Vishay personnel to obtain written terms and conditions regarding products designed for such applications.

No license, express or implied, by estoppel or otherwise, to any intellectual property rights is granted by this document or by any conduct of Vishay. Product names and markings noted herein may be trademarks of their respective owners.

Material Category Policy

Vishay Intertechnology, Inc. hereby certifies that all its products that are identified as RoHS-Compliant fulfill the definitions and restrictions defined under Directive 2011/65/EU of The European Parliament and of the Council of June 8, 2011 on the restriction of the use of certain hazardous substances in electrical and electronic equipment (EEE) - recast, unless otherwise specified as non-compliant.

Please note that some Vishay documentation may still make reference to RoHS Directive 2002/95/EC. We confirm that all the products identified as being compliant to Directive 2002/95/EC conform to Directive 2011/65/EU.