

# YAW5

YA W 5 12 E

① ② ③ ④ ⑤

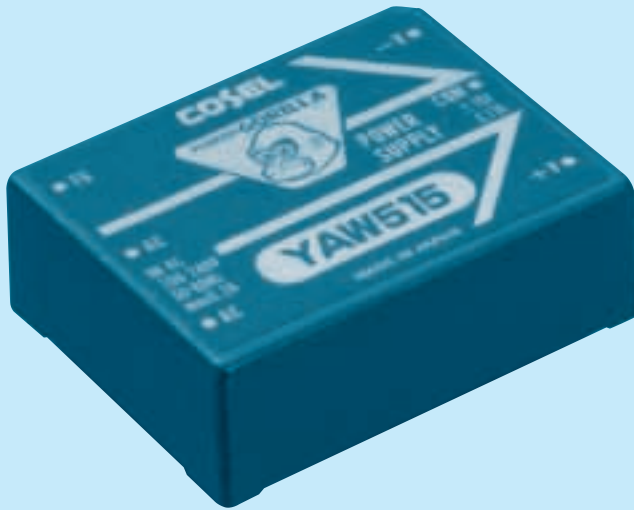

- ① Series name
- ② Dual output
- ③ Output wattage
- ④ Output voltage
- ⑤ UL recognized, TÜV approved, CSA certified: E

MODEL	YAW512	YAW515
MAX OUTPUT WATTAGE[W]	5.28	5.10
DC OUTPUT	*1 ±12V 0.22A or +24V 0.22A	±15V 0.17A or +30V 0.17A

## SPECIFICATIONS

	MODEL	YAW512	YAW515
INPUT	VOLTAGE[V]	AC85 - 264 1 φ or DC110 - 370	
	CURRENT[A]	ACIN 200V	0.07typ (Io=100%)
	FREQUENCY[Hz]	47 - 440 or DC	
	EFFICIENCY[%]	ACIN 100V	67typ (Io=100%)
	INRUSH CURRENT[A]	ACIN 100V ACIN 200V	20typ (Io=100%) 40typ (Io=100%)
OUTPUT	VOLTAGE[V]	±12 (+24)	±15 (+30)
	CURRENT[A]	0.22	0.17
	LINE REGULATION[mV]	60max	75max
	LOAD REGULATION[mV]	600max	750max
	RIPPLE[mVp-p]	*2 120max	120max
	RIPPLE NOISE[mVp-p]	*2 150max	150max
	TEMPERATURE REGULATION[mV]	0 to +55°C	180max
	OUTPUT VOLTAGE ADJUSTMENT RANGE[V]	Fixed	
OUTPUT VOLTAGE SETTING[%]	±5max (Rated input/output, Ta=25°C)		
HOLD-UP TIME[ms]	10typ (ACIN 85V, Io=100%)		
PROTECTION CIRCUIT	OVERCURRENT PROTECTION	Works over 105% of rating and recovers automatically	
ISOLATION	INPUT-OUTPUT	AC3,000V 1minute, Cutoff current = 15mA, DC500V 50MΩmin (At Room Temperature)	
	INPUT-FG	AC2,000V 1minute, Cutoff current = 10mA, DC500V 50MΩmin (At Room Temperature)	
	OUTPUT-FG	AC500V 1minute, Cutoff current=100mA, DC500V 50MΩmin (At Room Temperature)	
ENVIRONMENT	OPERATING TEMP., HUMID. AND ALTITUDE	-10 to +70°C, 20 - 95%RH (Non condensing) (Refer to DERATING CURVE), 3,000m (10,000feet) max	
	STORAGE TEMP., HUMID. AND ALTITUDE	-20 to +75°C, 20 - 95%RH (Non condensing), 9,000m (30,000feet) max	
	VIBRATION	10 - 55Hz, 98.0m/s <sup>2</sup> (10G), 3minutes period, 60minutes each along X, Y and Z axis	
	IMPACT	490.3m/s <sup>2</sup> (50G), 11ms, once each X, Y and Z axis	
SAFETY AND NOISE REGULATIONS	AGENCY APPROVALS	UL60950-1, EN60950-1, EN50178, CSA C22.2 No.60950-1 Complies with IEC60950-1	
	CONDUCTED NOISE	Complies with FCC-B, VCCI-B, Additional capacitors required for meeting CISPR22-B, EN55022-B (External Fuse is required)	

\*1 Output pins can be connected in series to make a 24V/30V output.  
 \*2 Measured by 20MHz oscilloscope.  
 \* The output specification is at ±12V and ±15V.  
 \* Parallel operation with other model is not possible.

External view

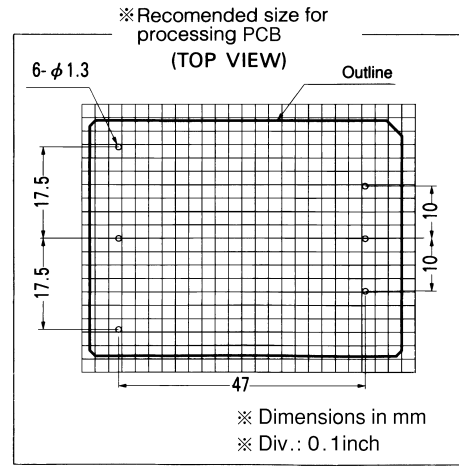
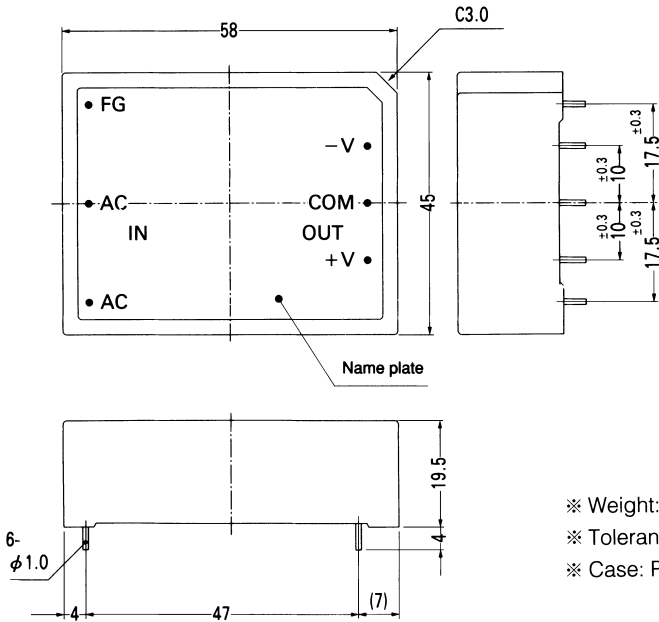

- ※ Weight: 85g or less
- ※ Tolerance: ±0.5
- ※ Case: PBT

Performance data

■ STATIC CHARACTERISTICS (YAW512)

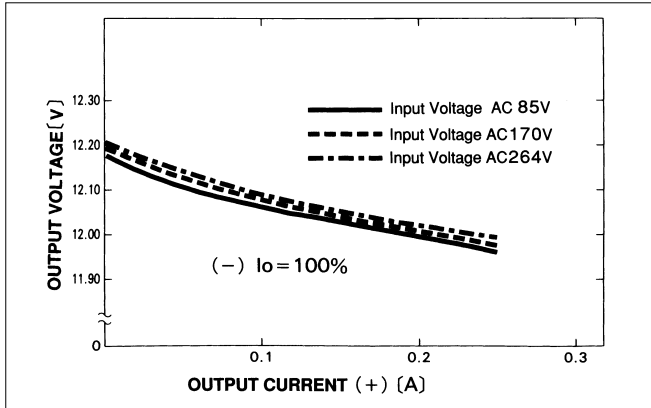

■ RISE TIME (YAW512: +12V)

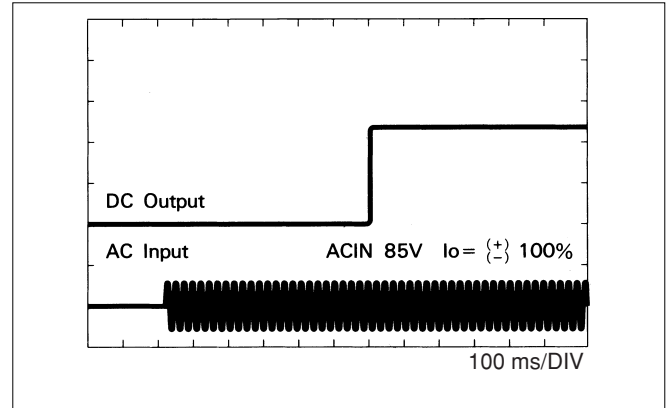

■ OVERCURRENT CHARACTERISTICS (YAW512)

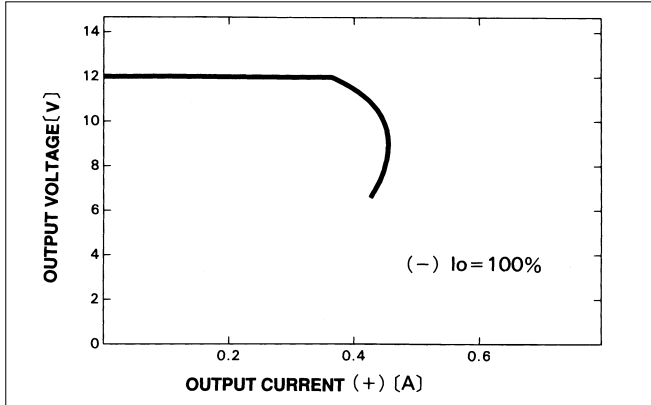

■ DERATING CURVE

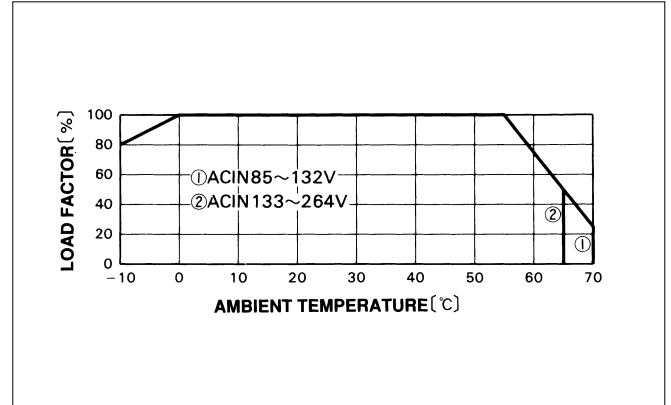

YA