

FJP5555

NPN Silicon Transistor

Features

- Fast Speed Switching
- Wide Safe Operating Area
- High Voltage Capability

Application

- Electronic Ballast
- Switch Mode Power Supplies

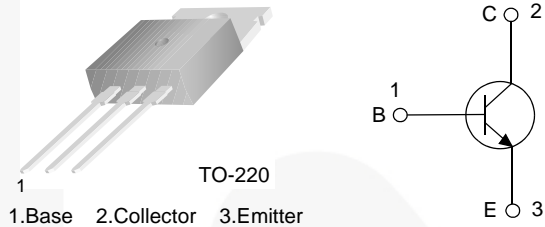

Ordering Information

Part Number	Marking	Package	Packing Method
FJP5555TU	J5555	TO-220	Rail

Absolute Maximum Ratings

Stresses exceeding the absolute maximum ratings may damage the device. The device may not function or be operable above the recommended operating conditions and stressing the parts to these levels is not recommended. In addition, extended exposure to stresses above the recommended operating conditions may affect device reliability. The absolute maximum ratings are stress ratings only. Values are at $T_A = 25^\circ\text{C}$ unless otherwise noted.

Symbol	Parameter	Value	Units
BV_{CBO}	Collector-Base Voltage	1050	V
BV_{CEO}	Collector-Emitter Voltage	400	V
BV_{EBO}	Emitter-Base Voltage	14	V
I_C	Collector Current (DC)	5	A
I_{CP}	Collector Current (Pulse)	10	A
I_B	Base Current (DC)	2	A
I_{BP}	Base Current (Pulse)	4	A
T_J	Junction Temperature	150	$^\circ\text{C}$
T_{STG}	Storage Temperature	- 55 to +150	$^\circ\text{C}$

Thermal Characteristics

Values are at $T_A = 25^\circ\text{C}$ unless otherwise noted.

Symbol	Parameter	Value	Units	
P_D	Total Device Dissipation	$T_A = 25^\circ\text{C}$	1.38	W
		$T_C = 25^\circ\text{C}$	75	W
$R_{\theta ja}^{(1)}$	Thermal Resistance, Junction to Ambient	90	$^\circ\text{C}/\text{W}$	
$R_{\theta jc}^{(2)}$	Thermal Resistance, Junction to Case	1.66	$^\circ\text{C}/\text{W}$	

Notes:

1. $R_{\theta ja}$ test board and fixture under natural convection, JESD51-10 recommended thermal test board.
2. $R_{\theta jc}$ test fixture under infinite cooling condition.

Electrical Characteristics⁽³⁾Values are at $T_A = 25^\circ\text{C}$ unless otherwise noted.

Symbol	Parameter	Conditions	Min.	Typ.	Max.	Units
BV_{CBO}	Collector-Base Voltage	$I_C = 500 \mu\text{A}, I_E = 0$	1050			V
BV_{CEO}	Collector-Emitter Voltage	$I_C = 5 \text{ mA}, I_B = 0$	400			V
BV_{EBO}	Emitter-Base Voltage	$I_E = 500 \mu\text{A}, I_C = 0$	14			V
h_{FE}	DC Current Gain	$V_{CE} = 5 \text{ V}, I_C = 10 \text{ mA}$	10			
		$V_{CE} = 3 \text{ V}, I_C = 0.8 \text{ A}$	20		40	
$V_{CE(sat)}$	Collector-Emitter Saturation Voltage	$I_C = 1 \text{ A}, I_B = 0.2 \text{ A}$			0.5	V
		$I_C = 3.5 \text{ A}, I_B = 1.0 \text{ A}$			1.5	V
$V_{BE(sat)}$	Base-Emitter Saturation Voltage	$I_C = 3.5 \text{ A}, I_B = 1.0 \text{ A}$			1.2	V
C_{ob}	Output Capacitance	$V_{CB} = 10 \text{ V}, f = 1 \text{ MHz}$		45		pF
t_{ON}	Turn-On Time	$V_{CC} = 125 \text{ V}, I_C = 0.5 \text{ A},$ $I_{B1} = 45 \text{ mA}, I_{B2} = 0.5 \text{ A},$ $R_L = 250 \Omega$			1.0	μs
t_{STG}	Storage Time				1.2	μs
t_F	Fall Time				0.3	μs
t_{ON}	Turn-On Time	$V_{CC} = 250 \text{ V}, I_C = 2.5 \text{ A},$ $I_{B1} = 0.5 \text{ A}, I_{B2} = 1.0 \text{ A},$ $R_L = 100 \Omega$			2.0	μs
t_{STG}	Storage Time				2.5	μs
t_F	Fall Time				0.3	μs
EAS	Avalanche Energy	$L = 2 \text{ mH}$	6			mJ

Note:3. Pulse test: pulse width $\leq 300 \mu\text{s}$, duty cycle $\leq 2\%$.

Typical Performance Characteristics

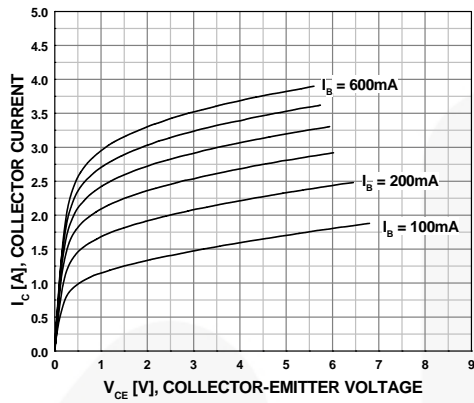

Figure 1. Static Characteristics

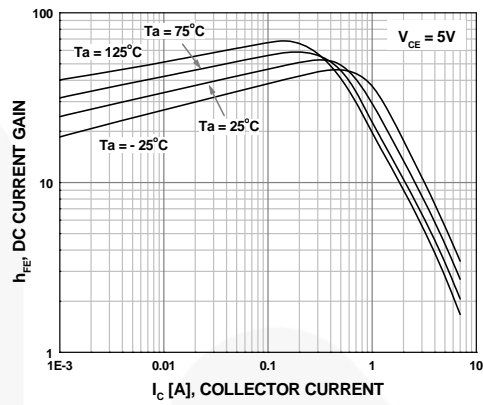

Figure 2. DC Current Gain

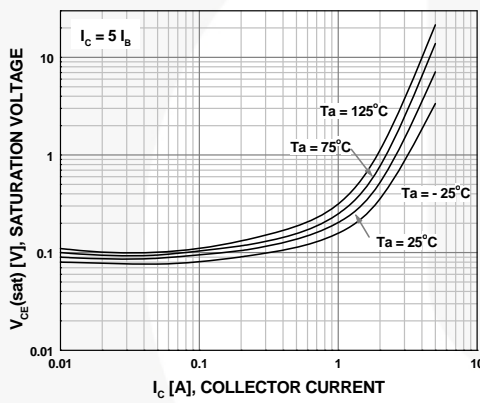

Figure 3. Saturation Voltage

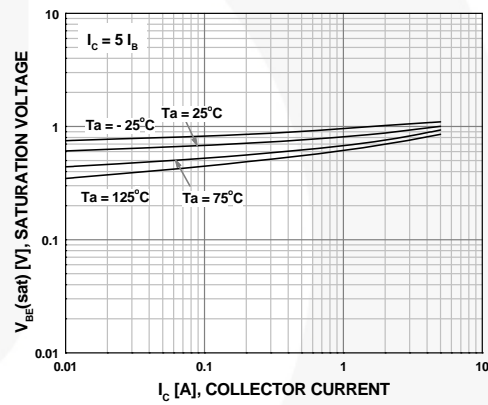

Figure 4. Saturation Voltage

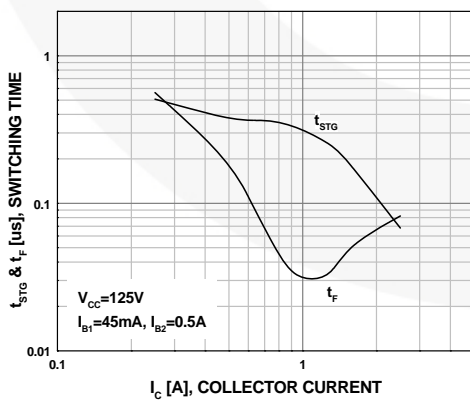

Figure 5. Resistive Load Switching

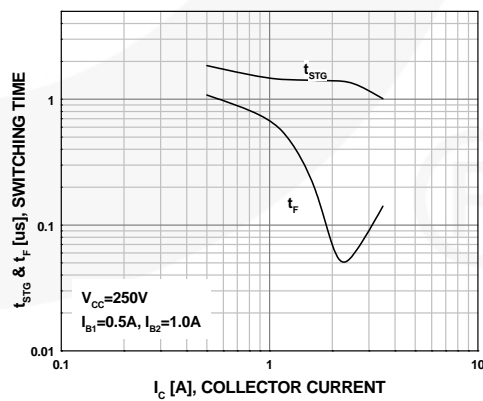

Figure 6. Resistive Load Switching

Typical Performance Characteristics (Continued)

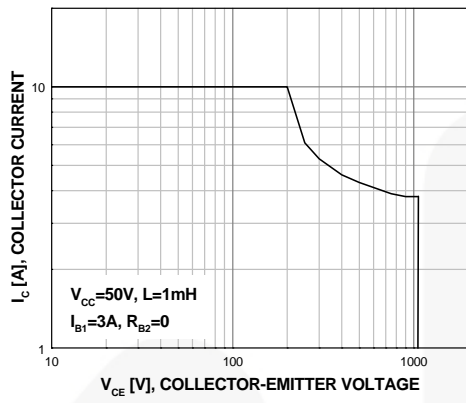

Figure 7. Reverse Biased Safe Operating Area

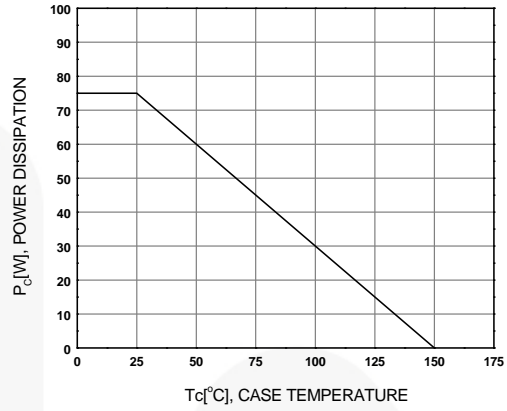

Figure 8. Power Derating

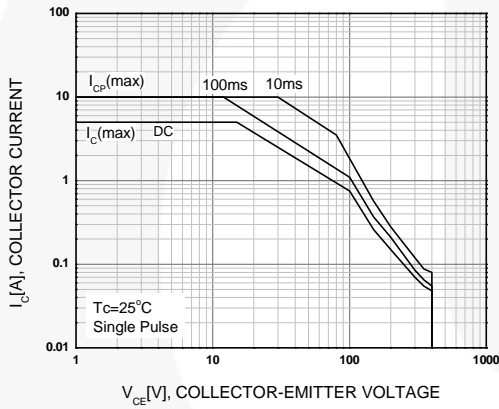
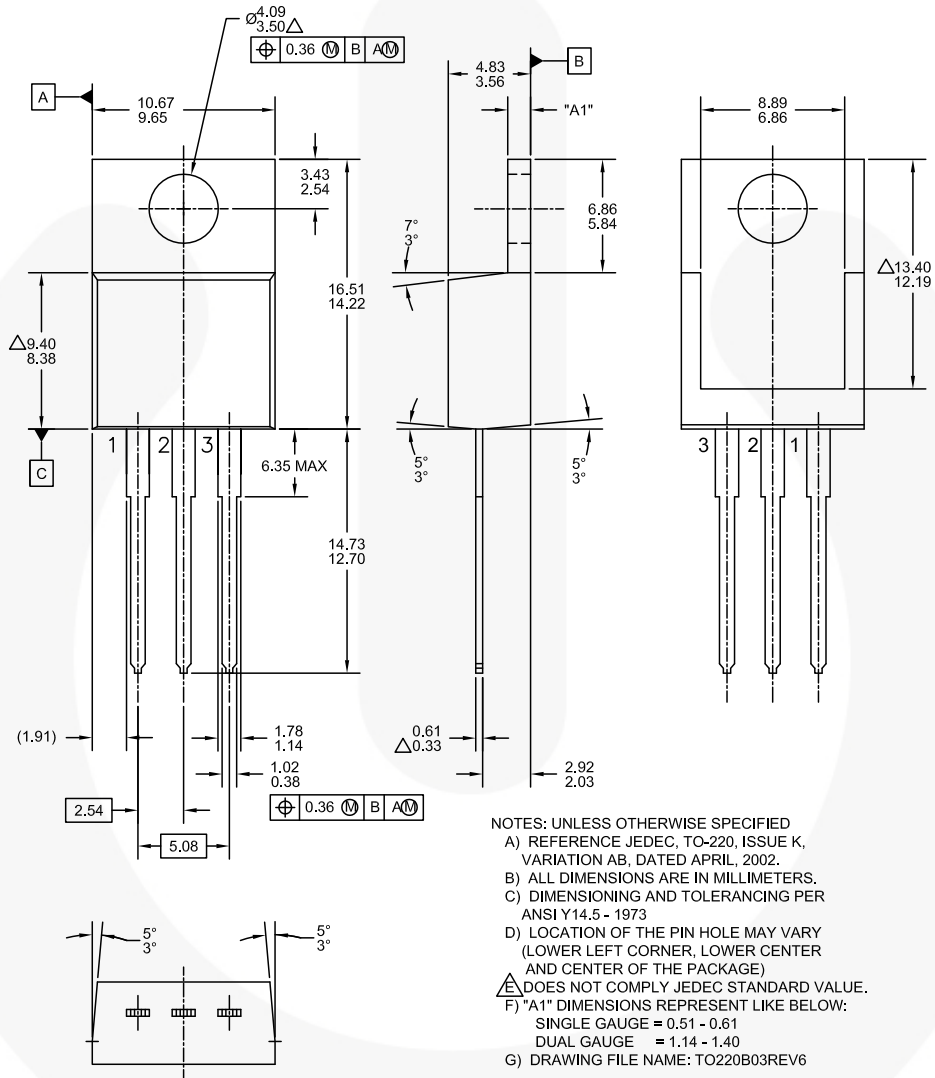

Figure 9. Forward Biased Safe Operating Area



Physical Dimensions

TO-220



- NOTES: UNLESS OTHERWISE SPECIFIED
 A) REFERENCE JEDEC, TO-220, ISSUE K, VARIATION AB, DATED APRIL, 2002.
 B) ALL DIMENSIONS ARE IN MILLIMETERS.
 C) DIMENSIONING AND TOLERANCING PER ANSI Y14.5 - 1973
 D) LOCATION OF THE PIN HOLE MAY VARY (LOWER LEFT CORNER, LOWER CENTER AND CENTER OF THE PACKAGE)
 E) DOES NOT COMPLY JEDEC STANDARD VALUE.
 F) "A1" DIMENSIONS REPRESENT LIKE BELOW:
 SINGLE GAUGE = 0.51 - 0.61
 DUAL GAUGE = 1.14 - 1.40
 G) DRAWING FILE NAME: TO220B03REV6

Figure 10. TO220, MOLDED, 3LD, JEDEC VARIATION (ACTIVE)





Package drawings are provided as a service to customers considering Fairchild components. Drawings may change in any manner without notice. Please note the revision and/or date on the drawing and contact a Fairchild Semiconductor representative to verify or obtain the most recent revision. Package specifications do not expand the terms of Fairchild's worldwide terms and conditions, specifically the warranty therein, which covers Fairchild products.

Always visit Fairchild Semiconductor's online packaging area for the most recent package drawings:
<http://www.fairchildsemi.com/packaging/>
 For current tape and reel specifications, visit Fairchild Semiconductor's online packaging area:
http://www.fairchildsemi.com/packing_dwg/PKG-TO220B03.pdf



TRADEMARKS

The following includes registered and unregistered trademarks and service marks, owned by Fairchild Semiconductor and/or its global subsidiaries, and is not intended to be an exhaustive list of all such trademarks.

- | | | | |
|---|--|---|---|
| 2Cool™ | FPS™ |  | Sync-Lock™ |
| AccuPower™ | F-PFS™ | PowerTrench® |  |
| AX-CAP®* | FRFET® | PowerXS™ | TinyBoost™ |
| BitSiC™ | Global Power Resource SM | Programmable Active Droop™ | TinyBuck™ |
| Build it Now™ | GreenBridge™ | QFET® | TinyCalc™ |
| CorePLUS™ | Green FPS™ | QS™ | TinyLogic® |
| CorePOWER™ | Green FPS™ e-Series™ | Quiet Series™ | TINYOPTO™ |
| CROSSVOLT™ | Gmax™ | RapidConfigure™ | TinyPower™ |
| CTL™ | GTO™ |  | TinyPWM™ |
| Current Transfer Logic™ | IntelliMAX™ | Saving our world, 1mW/W/kW at a time™ | TinyWire™ |
| DEUXPEED® | ISOPLANAR™ | SignalWise™ | TranSiC™ |
| Dual Cool™ | Making Small Speakers Sound Louder and Better™ | SmartMax™ | TriFault Detect™ |
| EcoSPARK® | MegaBuck™ | SMART START™ | TRUECURRENT®* |
| EfficientMax™ | MICROCOUPLER™ | Solutions for Your Success™ | μSerDes™ |
| ESBC™ | MicroFET™ | SPM® |  |
|  | MicroPak™ | STEALTH™ | UHC® |
| Fairchild® | MicroPak2™ | SuperFET® | Ultra FRFET™ |
| Fairchild Semiconductor® | MillerDrive™ | SuperSOT™-3 | UniFET™ |
| FACT Quiet Series™ | MotionMax™ | SuperSOT™-6 | VCX™ |
| FACT® | mWSaver™ | SuperSOT™-8 | VisualMax™ |
| FAST® | OptoHi™ | SupreMOS® | VoltagePlus™ |
| FastvCore™ | OPTOLOGIC® | SyncFET™ | XS™ |
| FETBench™ | OPTOPLANAR® | | |

* Trademarks of System General Corporation, used under license by Fairchild Semiconductor.

DISCLAIMER

FAIRCHILD SEMICONDUCTOR RESERVES THE RIGHT TO MAKE CHANGES WITHOUT FURTHER NOTICE TO ANY PRODUCTS HEREIN TO IMPROVE RELIABILITY, FUNCTION, OR DESIGN. FAIRCHILD DOES NOT ASSUME ANY LIABILITY ARISING OUT OF THE APPLICATION OR USE OF ANY PRODUCT OR CIRCUIT DESCRIBED HEREIN; NEITHER DOES IT CONVEY ANY LICENSE UNDER ITS PATENT RIGHTS, NOR THE RIGHTS OF OTHERS. THESE SPECIFICATIONS DO NOT EXPAND THE TERMS OF FAIRCHILD'S WORLDWIDE TERMS AND CONDITIONS, SPECIFICALLY THE WARRANTY THEREIN, WHICH COVERS THESE PRODUCTS.

LIFE SUPPORT POLICY

FAIRCHILD'S PRODUCTS ARE NOT AUTHORIZED FOR USE AS CRITICAL COMPONENTS IN LIFE SUPPORT DEVICES OR SYSTEMS WITHOUT THE EXPRESS WRITTEN APPROVAL OF FAIRCHILD SEMICONDUCTOR CORPORATION.

As used herein:

1. Life support devices or systems are devices or systems which, (a) are intended for surgical implant into the body or (b) support or sustain life, and (c) whose failure to perform when properly used in accordance with instructions for use provided in the labeling, can be reasonably expected to result in a significant injury of the user.
2. A critical component in any component of a life support, device, or system whose failure to perform can be reasonably expected to cause the failure of the life support device or system, or to affect its safety or effectiveness.

ANTI-COUNTERFEITING POLICY

Fairchild Semiconductor Corporation's Anti-Counterfeiting Policy. Fairchild's Anti-Counterfeiting Policy is also stated on our external website, www.fairchildsemi.com, under Sales Support.

Counterfeiting of semiconductor parts is a growing problem in the industry. All manufacturers of semiconductor products are experiencing counterfeiting of their parts. Customers who inadvertently purchase counterfeit parts experience many problems such as loss of brand reputation, substandard performance, failed applications, and increased cost of production and manufacturing delays. Fairchild is taking strong measures to protect ourselves and our customers from the proliferation of counterfeit parts. Fairchild strongly encourages customers to purchase Fairchild parts either directly from Fairchild or from Authorized Fairchild Distributors who are listed by country on our web page cited above. Products customers buy either from Fairchild directly or from Authorized Fairchild Distributors are genuine parts, have full traceability, meet Fairchild's quality standards for handling and storage and provide access to Fairchild's full range of up-to-date technical and product information. Fairchild and our Authorized Distributors will stand behind all warranties and will appropriately address any warranty issues that may arise. Fairchild will not provide any warranty coverage or other assistance for parts bought from Unauthorized Sources. Fairchild is committed to combat this global problem and encourage our customers to do their part in stopping this practice by buying direct or from authorized distributors.

PRODUCT STATUS DEFINITIONS

Definition of Terms

Datasheet Identification	Product Status	Definition
Advance Information	Formative / In Design	Datasheet contains the design specifications for product development. Specifications may change in any manner without notice.
Preliminary	First Production	Datasheet contains preliminary data; supplementary data will be published at a later date. Fairchild Semiconductor reserves the right to make changes at any time without notice to improve design.
No Identification Needed	Full Production	Datasheet contains final specifications. Fairchild Semiconductor reserves the right to make changes at any time without notice to improve the design.
Obsolete	Not In Production	Datasheet contains specifications on a product that is discontinued by Fairchild Semiconductor. The datasheet is for reference information only.