

Bracket

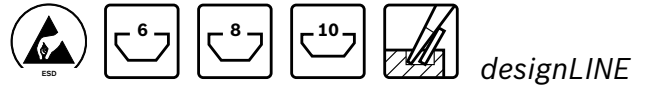





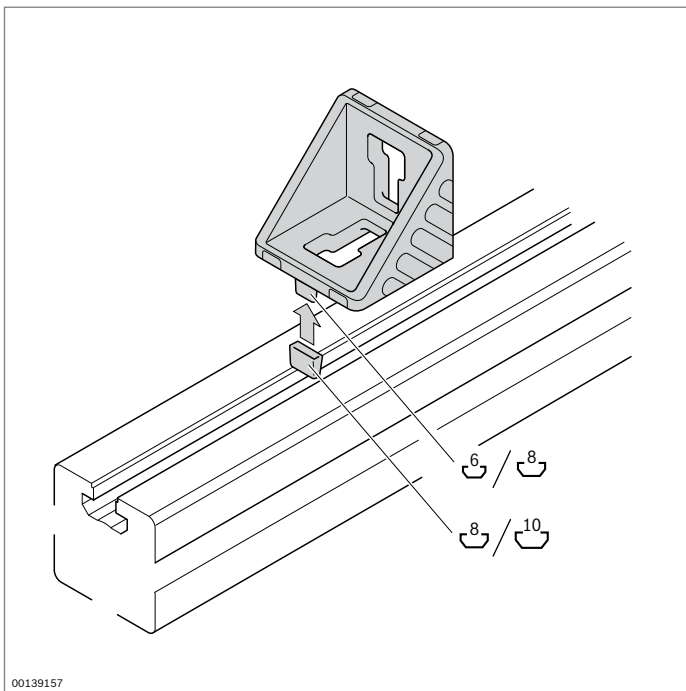

- ▶ Brackets with centering lugs for rapid, precise assembly with protection against turning
- ▶ Centering lugs can be easily broken off for assembly on plates or at right angles to the slot
- ▶ *designLINE* version with special silver paint (RAL 9006) for an attractive, high-quality design
- ▶ Intermediate element for positioning brackets in the next largest slot
- ▶ Offset sliding block for off-center positioning of the 45/45 bracket
- ▶ Cover cap to protect from dirt, available in signal gray (RAL 7004) and black ESD (RAL 9005)
- ▶ Profile finishing: not required

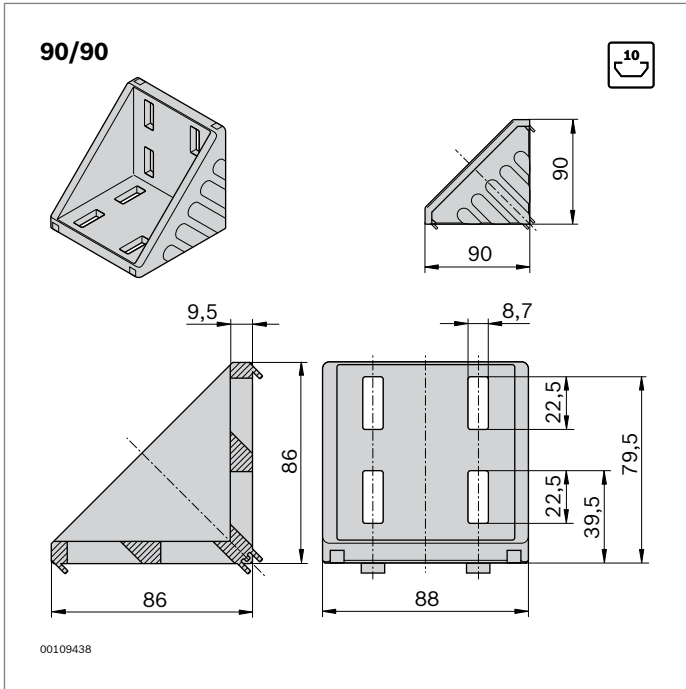
Technical data (p. 19-9)

Note: The collar screws enable the brackets to be assembled really quickly and easily (p. 3-5)







90/90	Slot	ESD		No.	FS
Set (standard)	10 / 10		1	3 842 523 578	8xFS7
<i>designLINE</i> set	10 / 10		1	3 842 551 613	8xFS7
Bracket (standard)	10		20	3 842 523 575	
Cover cap, signal gray			20	3 842 548 868	
Cover cap, black			20	3 842 548 869	

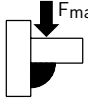
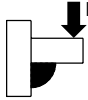
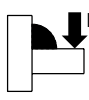

Material: Bracket: Diecast aluminum, vibratory ground
designLINE bracket: painted (RAL 9006)
 Cover cap: PP

Fastening material: steel; galvanized

Scope of delivery: set incl. fastening material (FS)

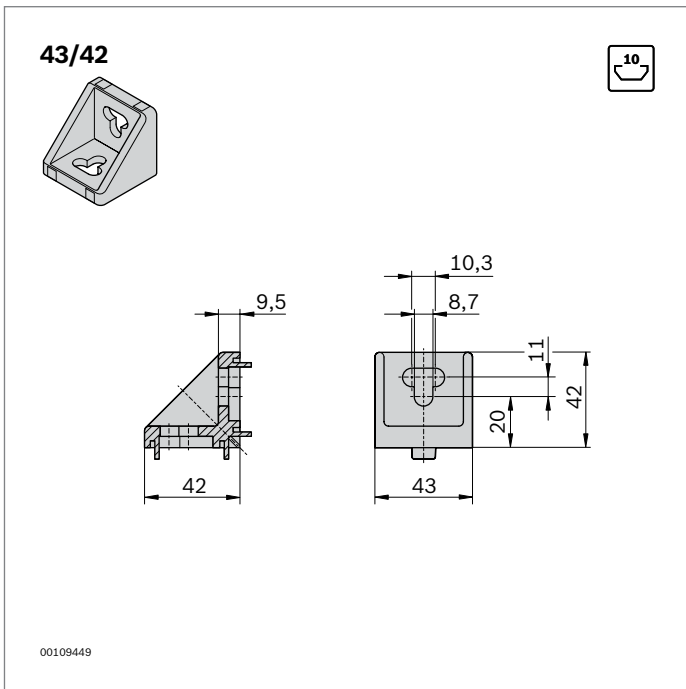
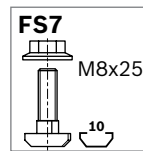
Type				
90/90	12000 N	370 Nm	800 Nm	200 Nm



43x42	Slot	ESD		No.	FS
Set (standard)	10 / 10		1	3 842 352 009	2xFS7
Bracket (standard)	10		100	3 842 348 526	

Material: Bracket: Die-cast aluminum

Fastening material: steel; galvanized

Scope of delivery: set incl. fastening material (FS)

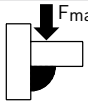
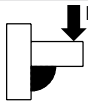
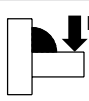
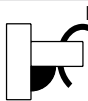
Type				
43x42	2000 N	-	160 Nm	-

