

FCP190N60_GF102

N-Channel SuperFET® II MOSFET

600 V, 20.2 A, 199 mΩ

Features

- 650 V @ $T_J = 150^\circ\text{C}$
- Typ. $R_{DS(on)} = 170\text{ m}\Omega$
- Ultra Low Gate Charge (Typ. $Q_g = 57\text{ nC}$)
- Low Effective Output Capacitance (Typ. $C_{oss(eff.)} = 160\text{ pF}$)
- 100% Avalanche Tested
- RoHS Compliant

Application

- LCD / LED / PDP TV Lighting
- Solar Inverter
- AC-DC Power Supply

Description

SuperFET® II MOSFET is Fairchild Semiconductor's brand-new high voltage super-junction (SJ) MOSFET family that is utilizing charge balance technology for outstanding low on-resistance and lower gate charge performance. This technology is tailored to minimize conduction loss, provide superior switching performance, dv/dt rate and higher avalanche energy. Consequently, SuperFET II MOSFET is very suitable for the switching power applications such as PFC, server/telecom power, FPD TV power, ATX power and industrial power applications.

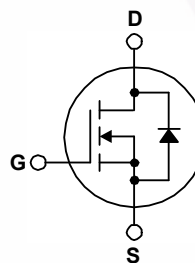
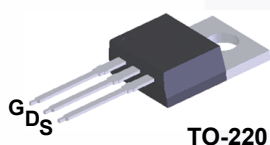

Absolute Maximum Ratings $T_C = 25^\circ\text{C}$ unless otherwise noted.

Symbol	Parameter	FCP190N60_GF102	Unit
V_{DSS}	Drain to Source Voltage	600	V
V_{GSS}	Gate to Source Voltage	- DC	± 20
		- AC (f > 1 Hz)	± 30
I_D	Drain Current	- Continuous ($T_C = 25^\circ\text{C}$)	20.2
		- Continuous ($T_C = 100^\circ\text{C}$)	12.7
I_{DM}	Drain Current	- Pulsed (Note 1)	60.6 A
E_{AS}	Single Pulsed Avalanche Energy	(Note 2)	400 mJ
I_{AR}	Avalanche Current	(Note 1)	4.0 A
E_{AR}	Repetitive Avalanche Energy	(Note 1)	2.1 mJ
dv/dt	MOSFET dv/dt		100 V/ns
	Peak Diode Recovery dv/dt	(Note 3)	20
P_D	Power Dissipation	($T_C = 25^\circ\text{C}$)	208 W
		- Derate Above 25°C	1.67 W/ $^\circ\text{C}$
T_J, T_{STG}	Operating and Storage Temperature Range	-55 to +150	$^\circ\text{C}$
T_L	Maximum Lead Temperature for Soldering, 1/8" from Case for 5 Seconds	300	$^\circ\text{C}$

Thermal Characteristics

Symbol	Parameter	FCP190N60_GF102	Unit
$R_{\theta JC}$	Thermal Resistance, Junction to Case, Max.	0.6	$^\circ\text{C/W}$
$R_{\theta JA}$	Thermal Resistance, Junction to Ambient, Max.	62.5	

Package Marking and Ordering Information

Part Number	Top Mark	Package	Packing Method	Reel Size	Tape Width	Quantity
FCP190N60_GF102	FCP190N60 GF102	TO-220	Tube	N/A	N/A	50 units

Electrical Characteristics $T_C = 25^\circ\text{C}$ unless otherwise noted.

Symbol	Parameter	Test Conditions	Min.	Typ.	Max.	Unit
--------	-----------	-----------------	------	------	------	------

Off Characteristics

BV_{DSS}	Drain to Source Breakdown Voltage	$V_{GS} = 0\text{ V}, I_D = 10\text{ mA}, T_J = 25^\circ\text{C}$	600	-	-	V
		$V_{GS} = 0\text{ V}, I_D = 10\text{ mA}, T_J = 150^\circ\text{C}$	650	-	-	
$\Delta BV_{DSS} / \Delta T_J$	Breakdown Voltage Temperature Coefficient	$I_D = 10\text{ mA}$, Referenced to 25°C	-	0.67	-	$\text{V}/^\circ\text{C}$
BV_{DS}	Drain to Source Avalanche Breakdown Voltage	$V_{GS} = 0\text{ V}, I_D = 20\text{ A}$	-	700	-	V
I_{DSS}	Zero Gate Voltage Drain Current	$V_{DS} = 480\text{ V}, V_{GS} = 0\text{ V}$	-	-	1	μA
		$V_{DS} = 480\text{ V}, T_C = 125^\circ\text{C}$	-	-	10	
I_{GSS}	Gate to Body Leakage Current	$V_{GS} = \pm 20\text{ V}, V_{DS} = 0\text{ V}$	-	-	± 100	nA

On Characteristics

$V_{GS(th)}$	Gate Threshold Voltage	$V_{GS} = V_{DS}, I_D = 250\ \mu\text{A}$	2.5	-	3.5	V
$R_{DS(on)}$	Static Drain to Source On Resistance	$V_{GS} = 10\text{ V}, I_D = 10\text{ A}$	-	0.17	0.199	Ω
g_{FS}	Forward Transconductance	$V_{DS} = 20\text{ V}, I_D = 10\text{ A}$	-	21	-	S

Dynamic Characteristics

C_{iss}	Input Capacitance	$V_{DS} = 25\text{ V}, V_{GS} = 0\text{ V}, f = 1\text{ MHz}$	-	2220	2950	pF	
C_{oss}	Output Capacitance		-	1630	2165	pF	
C_{rSS}	Reverse Transfer Capacitance		-	85	128	pF	
C_{oss}	Output Capacitance	$V_{DS} = 380\text{ V}, V_{GS} = 0\text{ V}, f = 1\text{ MHz}$	-	42	-	pF	
$C_{oss(eff.)}$	Effective Output Capacitance	$V_{DS} = 0\text{ V to } 480\text{ V}, V_{GS} = 0\text{ V}$	-	160	-	pF	
$Q_{g(tot)}$	Total Gate Charge at 10V	$V_{DS} = 380\text{ V}, I_D = 10\text{ A}, V_{GS} = 10\text{ V}$	-	57	74	nC	
Q_{gs}	Gate to Source Gate Charge		-	9	-	nC	
Q_{gd}	Gate to Drain "Miller" Charge		(Note 4)	-	21	-	nC
ESR	Equivalent Series Resistance		$f = 1\text{ MHz}$	-	1	-	Ω

Switching Characteristics

$t_{d(on)}$	Turn-On Delay Time	$V_{DD} = 380\text{ V}, I_D = 10\text{ A}, V_{GS} = 10\text{ V}, R_g = 4.7\ \Omega$	-	20	50	ns
t_r	Turn-On Rise Time		-	10	30	ns
$t_{d(off)}$	Turn-Off Delay Time		-	64	138	ns
t_f	Turn-Off Fall Time		(Note 4)	-	5	20

Drain-Source Diode Characteristics

I_S	Maximum Continuous Drain to Source Diode Forward Current	-	-	20.2	A	
I_{SM}	Maximum Pulsed Drain to Source Diode Forward Current	-	-	60.6	A	
V_{SD}	Drain to Source Diode Forward Voltage	$V_{GS} = 0\text{ V}, I_{SD} = 10\text{ A}$	-	-	1.2	V
t_{rr}	Reverse Recovery Time	$V_{GS} = 0\text{ V}, I_{SD} = 10\text{ A}, di_F/dt = 100\text{ A}/\mu\text{s}$	-	280	-	ns
Q_{rr}	Reverse Recovery Charge		-	3.8	-	μC

Notes:

1. Repetitive rating: pulse-width limited by maximum junction temperature.
2. $I_{AS} = 4\text{ A}, V_{DD} = 50\text{ V}, R_G = 25\ \Omega$, starting $T_J = 25^\circ\text{C}$.
3. $I_{SD} \leq 10\text{ A}, di/dt \leq 200\text{ A}/\mu\text{s}, V_{DD} \leq BV_{DSS}$, starting $T_J = 25^\circ\text{C}$.
4. Essentially independent of operating temperature typical characteristics.

Typical Performance Characteristics

Figure 1. On-Region Characteristics

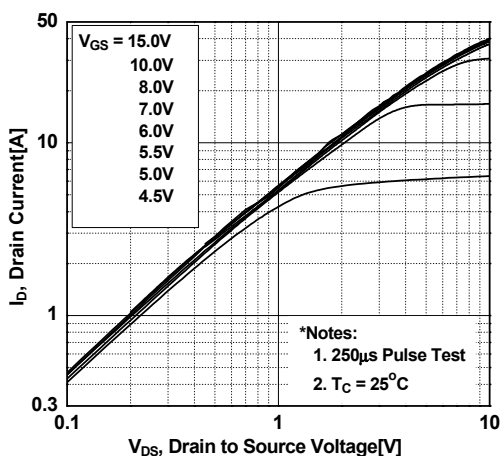

Figure 2. Transfer Characteristics

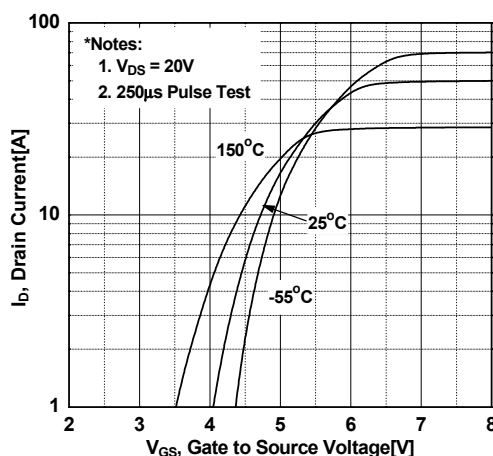

Figure 3. On-Resistance Variation vs. Drain Current and Gate Voltage

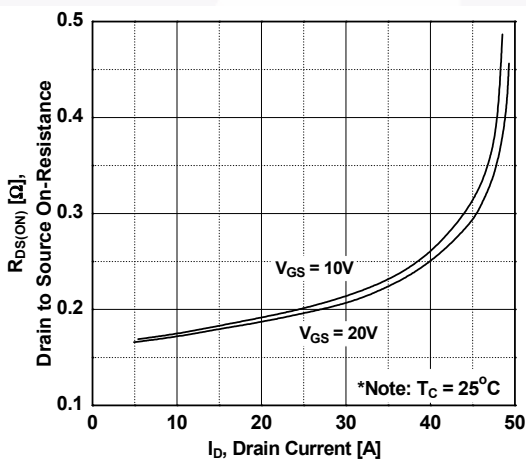

Figure 4. Body Diode Forward Voltage Variation vs. Source Current and Temperature

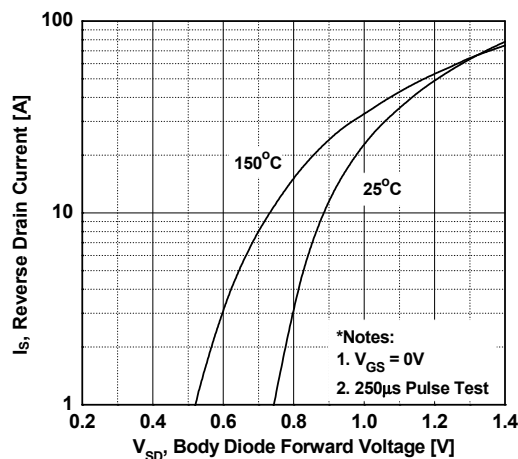

Figure 5. Capacitance Characteristics

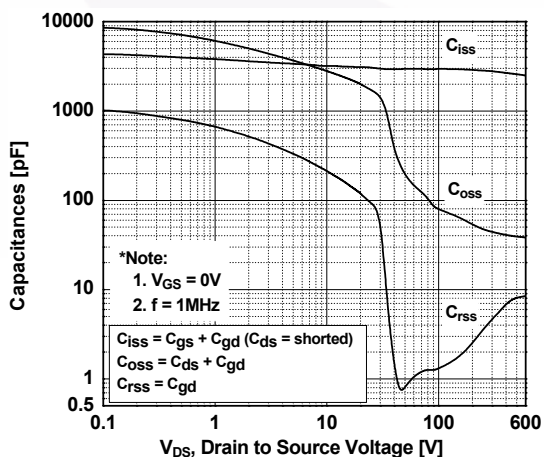
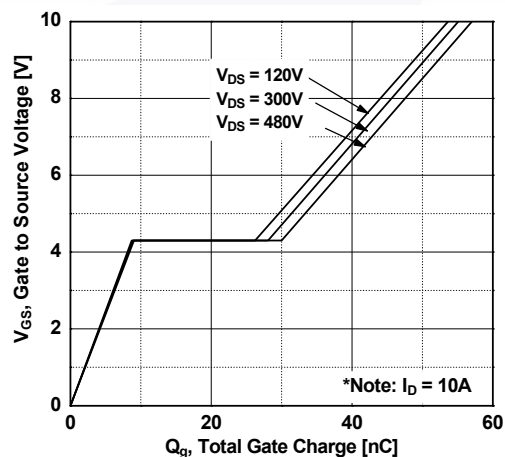

Figure 6. Gate Charge Characteristics



Typical Performance Characteristics (Continued)

Figure 7. Breakdown Voltage Variation vs. Temperature

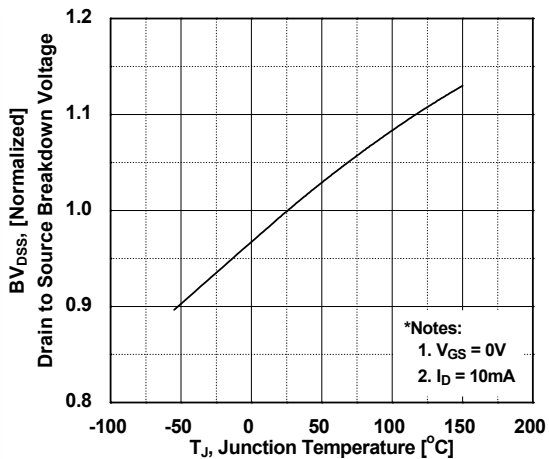

Figure 8. On-Resistance Variation vs. Temperature

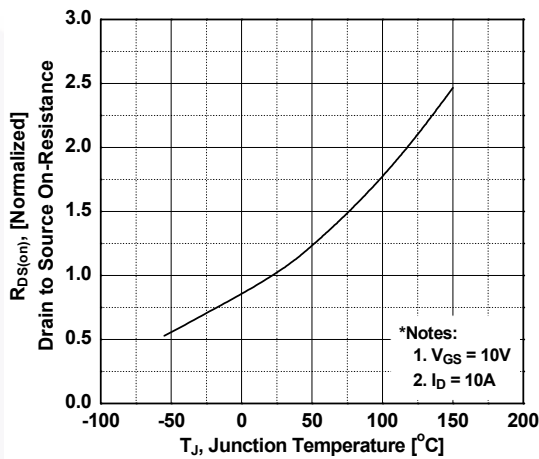

Figure 9. Maximum Safe Operating Area

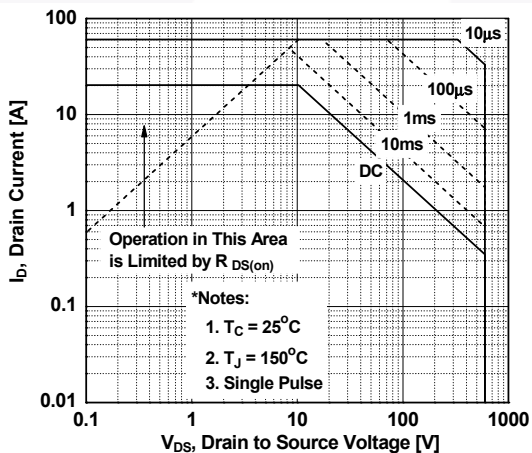

Figure 10. Maximum Drain Current vs. Case Temperature

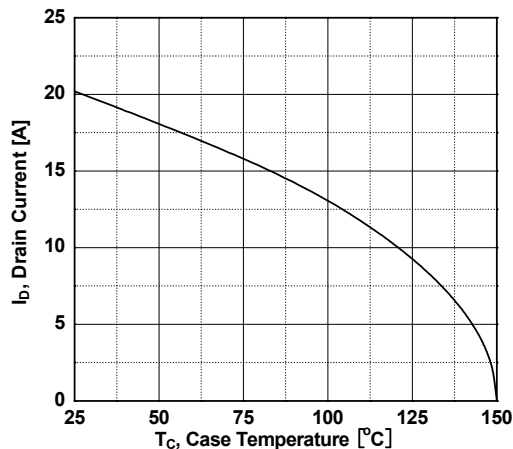
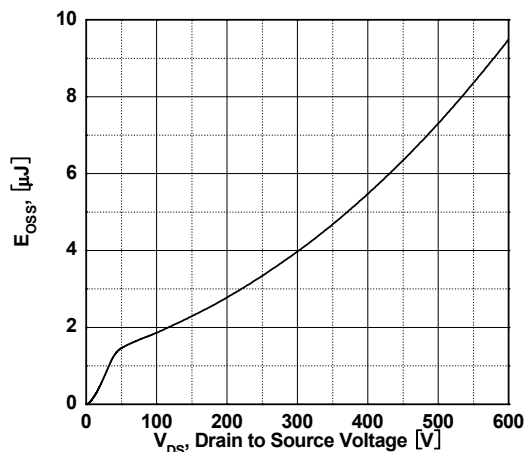
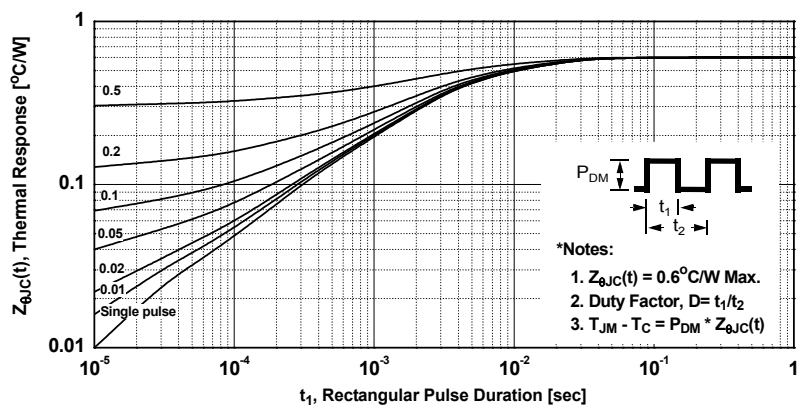

Figure 11. E_oss vs. Drain to Source Voltage



Typical Performance Characteristics (Continued)

Figure 12. Transient Thermal Response Curve



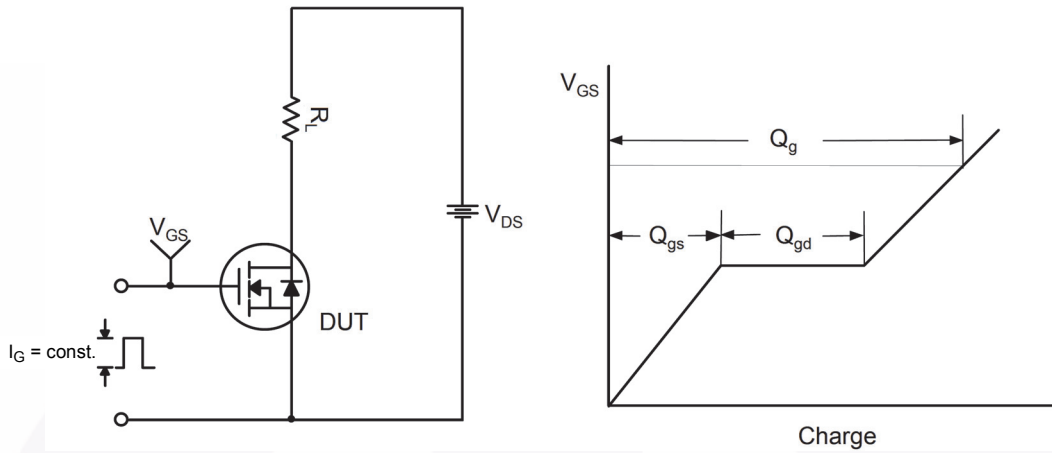

Figure 13. Gate Charge Test Circuit & Waveform



Figure 14. Resistive Switching Test Circuit & Waveforms



Figure 15. Unclamped Inductive Switching Test Circuit & Waveforms

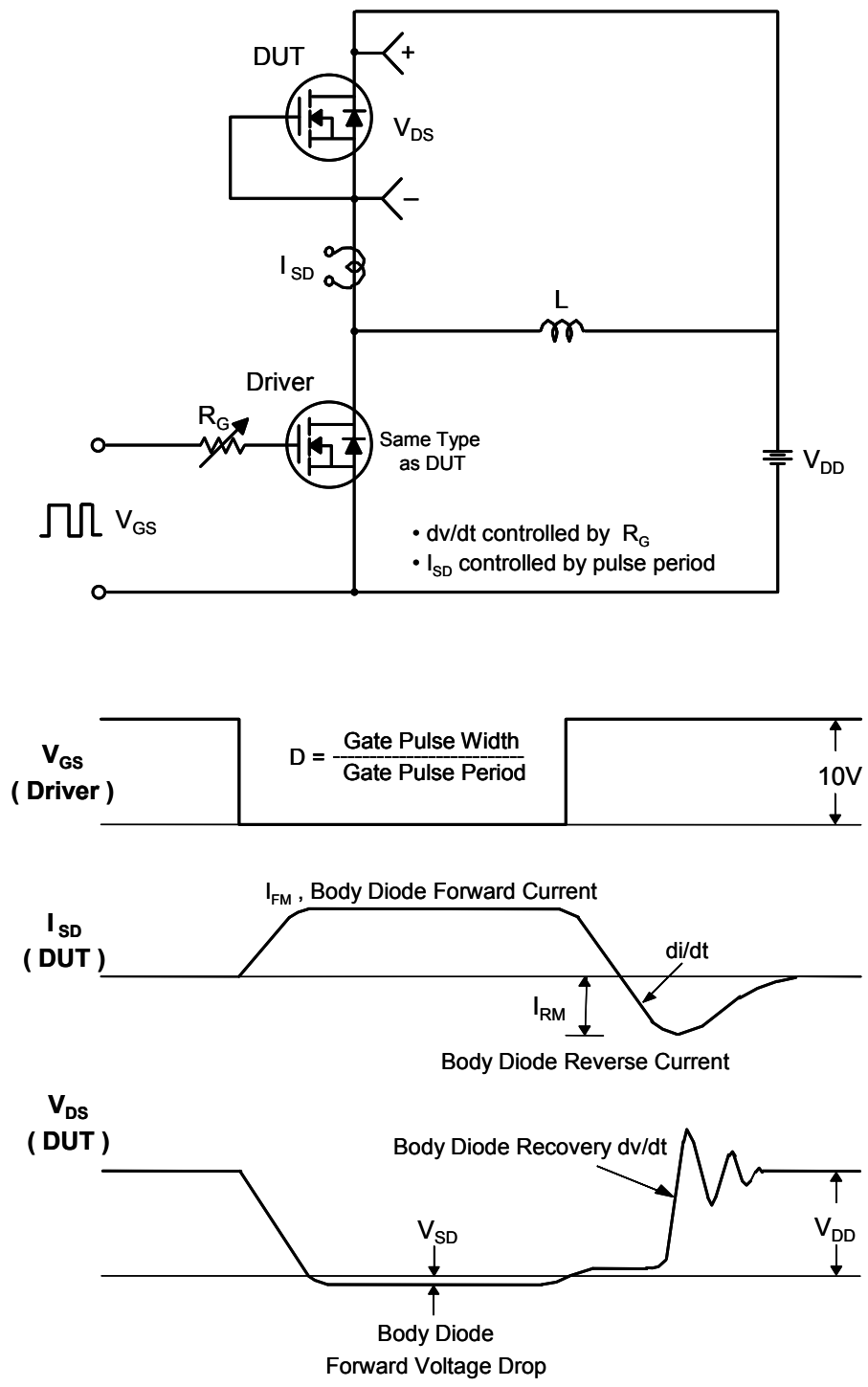

Figure 16. Peak Diode Recovery dv/dt Test Circuit & Waveforms

Mechanical Dimensions

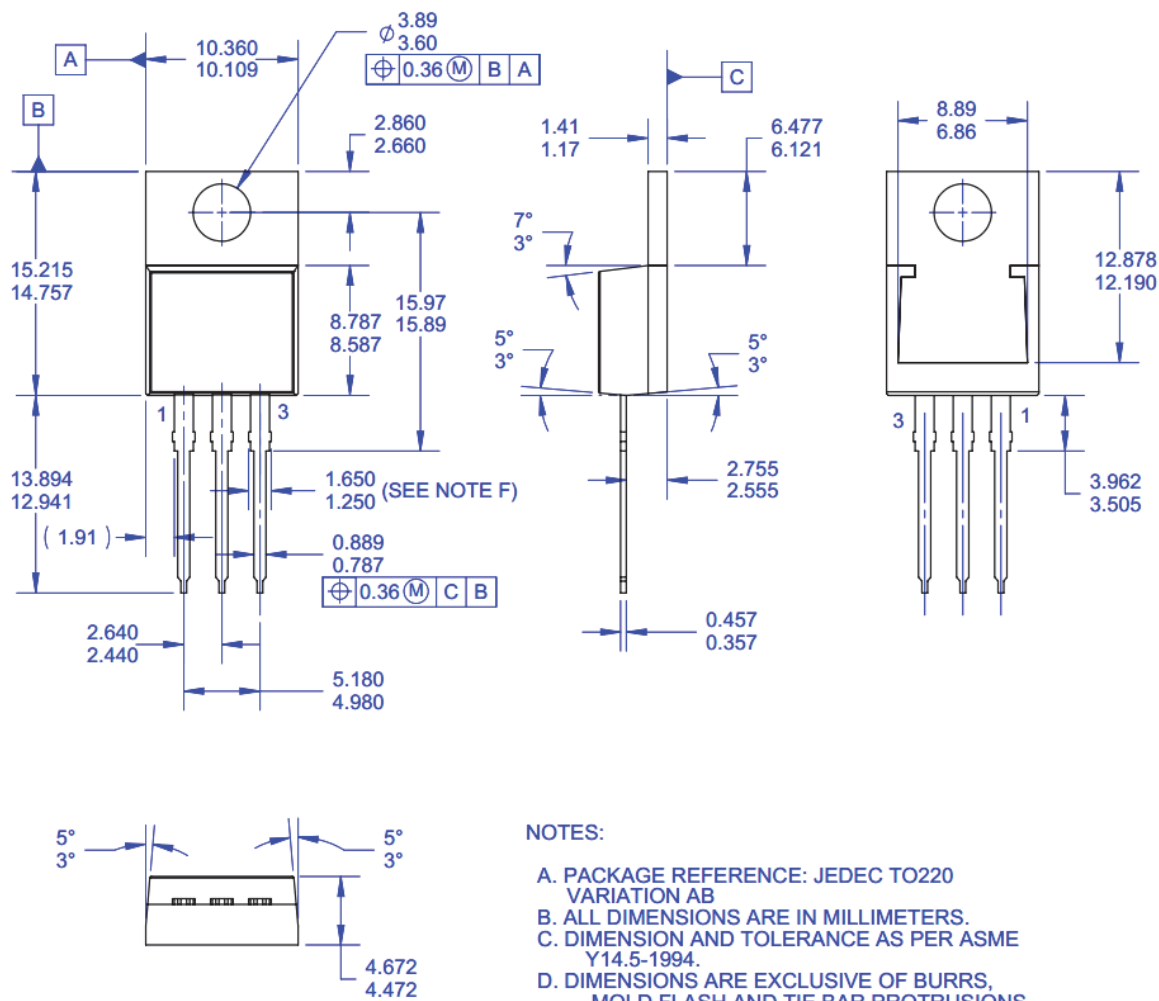

Figure 17. TO-220, Molded, 3-Lead, Jedec Variation AB (Delta)

Package drawings are provided as a service to customers considering Fairchild components. Drawings may change in any manner without notice. Please note the revision and/or date on the drawing and contact a Fairchild Semiconductor representative to verify or obtain the most recent revision. Package specifications do not expand the terms of Fairchild's worldwide terms and conditions, specifically the warranty therein, which covers Fairchild products.

Always visit Fairchild Semiconductor's online packaging area for the most recent package drawings:

http://www.fairchildsemi.com/package/packageDetails.html?id=PN_TT220-013

