

Relay



Products Features

PCB Relay G6B-1114

Subminiature Relay that Switches up to 5 A

- Subminiature: 20 × 10 × 10 mm (L × W × H).
- Low power consumption: 200 mW.
- Unique moving loop armature reduces relay size, magnetic interference, and contact bounce time.
- Single- and double-winding latching types also available.

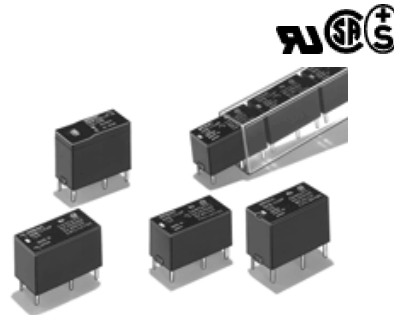

Dimensions

Note: 1. All units are in millimeters unless otherwise

2. Orientation marks are indicated as follows:

G6B-1114P-US G6BU-1114P-US

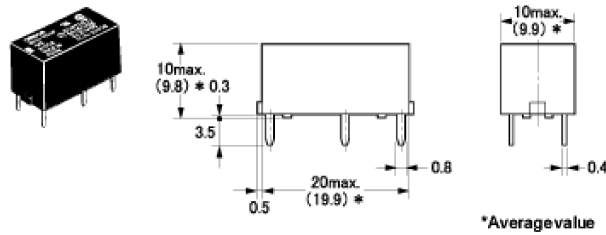

G6B-1114C-US G6BU-1114C-US

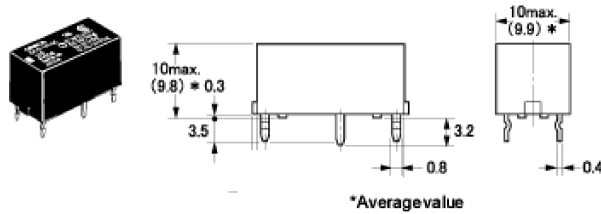

Terminal Arrangement / Internal Connections (BOTTOM VIEW)

G6B-1114P, -1114C

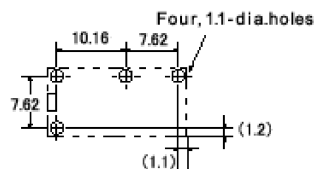

Mounting Holes (BOTTOM VIEW)

G6B-1114P, -1114C
G6BU-1114P, -1114C

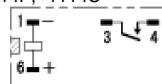

G6BU-1114P, -1114C (BOTTOM VIEW)

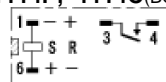

G6BK-1114P-US

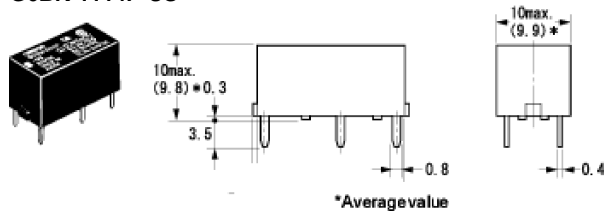

G6BK-1114C-US

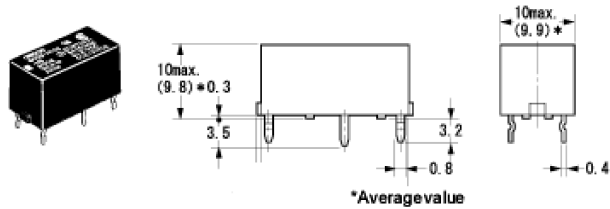

Terminal Arrangement / Internal Connections
(BOTTOM VIEW)
G6BK-1114P, -1114C

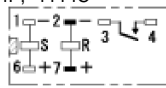

Mounting Holes
(BOTTOM VIEW)
G6BK-1114P, -1114C

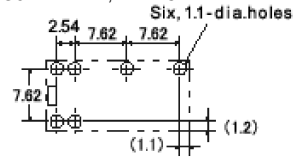

Back Connecting Socket
P6B-04P

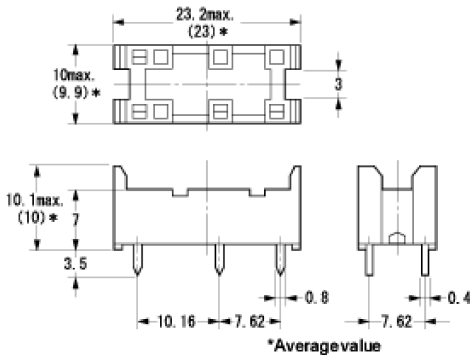

Mounting Holes
(BOTTOM VIEW)

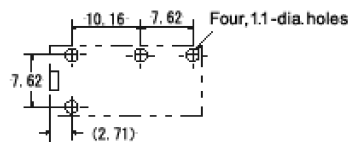

P6B-06P

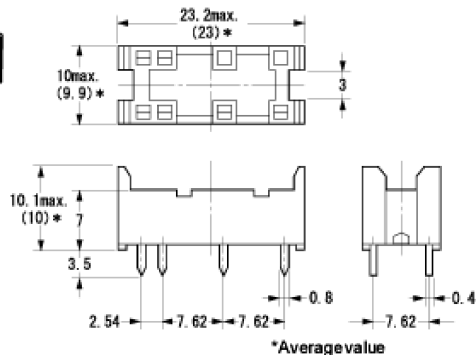
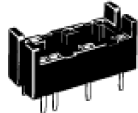

Mounting Holes
(BOTTOM VIEW)

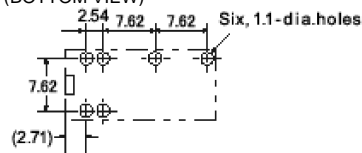

Removal Tool P6B-Y1



Hold-down Clips P6B-C2



Note: 1 P6B-C2 Hold-down Clips cannot be used for G6B-1174P-US.

Relay



Products Features

PCB Relay G6B-1114

Ordering Information Ratings / Characteristics Dimensions

Subminiature Relay that Switches up to 5 A

- Subminiature: 20 × 10 × 10 mm (L × W × H).
- Low power consumption: 200 mW.
- Unique moving loop armature reduces relay size, magnetic interference, and contact bounce time.
- Single- and double-winding latching types also available.

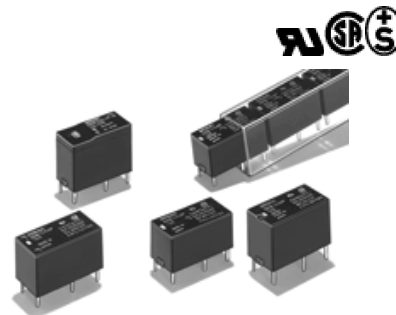

Ratings / Characteristics

Coil Ratings

Single-side Stable Type

Item	SPST-NO					SPST-NO + SPST-NC, DPST-NO, DPST-NC					
	3	5	6	12	24	3	5	6	12	24	
Rated voltage (VDC)	3	5	6	12	24	3	5	6	12	24	
Rated current (mA)	67	40	33.3	16.7	8.3	100	60	50	25	12.5	
Coil resistance (Ω)	45	125	180	720	2,880	30	83.3	120	480	1,920	
Coil inductance (H) (ref. value)	Armature OFF		0.20	0.28	0.31	1.2	4.9	---			
	Armature ON		0.18	0.26	0.28	1.1	4.1	---			
Must operate voltage	70% max. of rated voltage					80% max. of rated voltage					
Must release voltage	10% min. of rated voltage										
Max. voltage	160% of rated voltage (at 23°C)					140% of rated voltage (at 23°C)					
Power consumption	Approx. 200 mW					Approx. 300 mW					

Single-winding Latching Type

Rated voltage		3 VDC	5 VDC	6 VDC	12 VDC	24 VDC
Rated current		67 mA	40 mA	33.3 mA	16.7 mA	8.3 mA
Coil resistance		45 Ω	125 Ω	180 Ω	720 Ω	2,880 Ω
Coil inductance(H) (ref. value)	Armature OFF	0.20	0.28	0.31	1.2	4.9
	Armature ON	0.18	0.26	0.28	1.1	4.1
Must operate voltage		70% max. of rated voltage				
Must release voltage		70% min. of rated voltage				
Max. voltage		160% of rated voltage (at 23°C)				
Power consumption		Approx. 200 mW				

Double-winding Latching Type

Rated voltage		3 VDC	5 VDC	6 VDC	12 VDC	24 VDC
Set coil	Rated current	93.2 mA	56 mA	46.8 mA	23.3 mA	11.7 mA
	Coil resistance	32.2 Ω	89.2 Ω	128.5 Ω	515 Ω	2,060 Ω
	Coil inductance(H) (ref. value)	Armature OFF		0.11	0.15	0.18
		Armature ON		0.11	0.15	0.18
		0.52	1.2	0.52	1.2	

Must set voltage	70% max. of rated voltage
Must reset voltage	70% min. of rated voltage
Max. voltage	130% of rated voltage (at 23°C)
Power consumption	Set coil: Approx. 280 mW Reset coil: Approx. 280 mW

Note:1. The rated current and coil resistance are measured at a coil temperature of 23°C with a tolerance of ±10%.
2. Operating characteristics are measured at a coil temperature of 23°C.

Contact Ratings

Item	SPST-NO		SPST-NO + SPST-NC, DPST-NO, DPST-NC	
	Resistive load (cosφ = 1)	Inductive load (cosφ = 0.4; L/R = 7 ms)	Resistive load (cosφ = 1)	Inductive load (cosφ = 0.4; L/R = 7 ms)
Rated load	5 A at 250 VAC; 5A at 30 VDC	2 A at 250 VAC; 2 A at 30 VDC	5 A at 250 VAC; 5A at 30 VDC	1.5 A at 250 VAC; 1.5 A at 30 VDC
Contact material	AgCdO			
Rated carry current	5 A			
Max. switching voltage	380 VAC, 125 VDC			
Max. switching current	5 A			
Max. switching power	1,250 VA, 150 W	500 VA, 60 W	1,250 VA, 150 W	375 VA, 80 W
Failure rate (reference value)	10 mA at 5 VDC			

Item	SPST-NO (High-capacity)	
Load	Resistive load (cosφ = 1)	Inductive load (cosφ = 0.4; L/R = 7 ms)
Rated load	8 A at 250 VAC; 5A at 30 VDC	2 A at 250 VAC; 2 A at 30 VDC
Contact material	AgCdO	
Rated carry current	8 A	
Max. switching voltage	380 VAC, 125 VDC	
Max. switching current	8 A	
Max. switching power	2,000 VA, 150 W	
Failure rate (reference value)	10 mA at 5 VDC	

Note: P level: $\lambda_{60} = 0.1 \times 10^{-6}$ /operation

Characteristics

Contact resistance	30 mΩ max.
Operate (set) time	10 ms max. (mean value: 1-pole approx. 3 ms, 2-pole approx. 4 ms)
Release (reset) time	Single-side stable types: 10 ms max. (mean value: 1-pole approx. 1 ms, 2-pole approx. 2 ms) Latching types: 10 ms max. (mean value: approx. 3 ms)
Min. set/reset signal width	Latching type: 15 ms min. (at 23°C)
Max. operating frequency	Mechanical: 18,000 operations/hr Electrical: 1,800 operations/hr (under rated load)
Insulation resistance	1,000 MΩ min. (at 500 VDC, at 250 VDC between set coil and reset coil)

Dielectric strength	3,000 VAC (Latching types: 2,000 VAC), 50/60 Hz for 1 min between coil and contacts 1,000 VAC, 50/60 Hz for 1 min between contacts of same polarity 250 VAC, 50/60 Hz for 1 min between set and reset coils 2,000 VAC, 50/60 Hz for 1 min between contacts of different polarity
Vibration resistance	Destruction: 10 to 55 to 10 Hz, 0.75-mm single amplitude (1.5-mm double amplitude) Malfunction: 10 to 55 to 10 Hz, 0.75-mm single amplitude (1.5-mm double amplitude)
Shock resistance	Destruction: 1,000 m/s ² Malfunction: Single-side stable: 100 m/s ² ; Latching: 300 m/s ²
Endurance	Mechanical: 50,000,000 operations min. (at 18,000 operations/hr) Electrical: 100,000 operation min. (at 1,800 operations/hr)
Ambient temperature	Operating: -25°C to 70°C (with no icing)
Ambient humidity	Operating: 5% to 85%
Weight	Double-winding latching: Approx. 3.7 g High-capacity: Approx. 4.6 g Double pole: Approx. 4.5 g Other: Approx. 3.5 g

Note: The data shown above are initial values.

Relay



Products Features

PCB Relay G6B-1114

Ordering Information Ratings / Characteristics Dimensions

Subminiature Relay that Switches up to 5 A

- Subminiature: 20 × 10 × 10 mm (L × W × H).
- Low power consumption: 200 mW.
- Unique moving loop armature reduces relay size, magnetic interference, and contact bounce time.
- Single- and double-winding latching types also available.

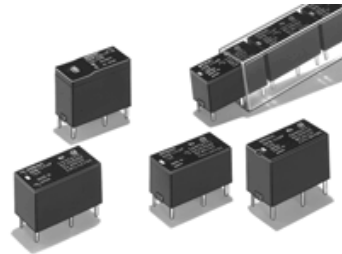

Dimensions

Note: 1. All units are in millimeters unless otherwise

2. Orientation marks are indicated as follows:

G6B-1114P-US G6BU-1114P-US

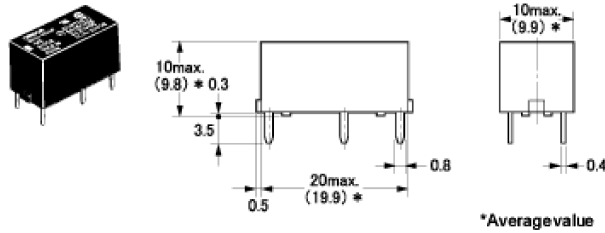

G6B-1114C-US G6BU-1114C-US

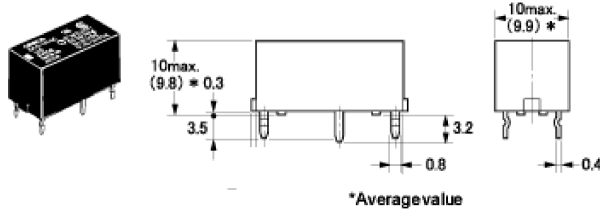

Terminal Arrangement / Internal Connections (BOTTOM VIEW)

G6B-1114P, -1114C

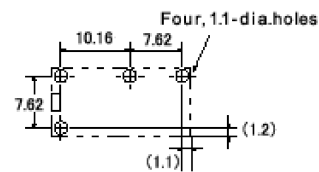

Mounting Holes (BOTTOM VIEW)

G6B-1114P, -1114C
G6BU-1114P, -1114C

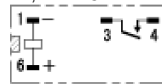

G6BU-1114P, -1114C (BOTTOM VIEW)

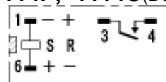

G6BK-1114P-US

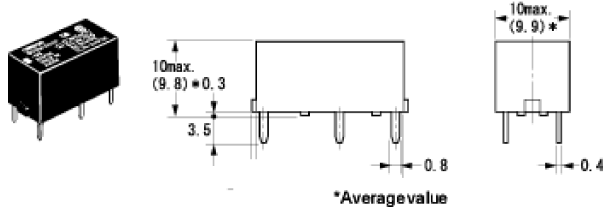

G6BK-1114C-US

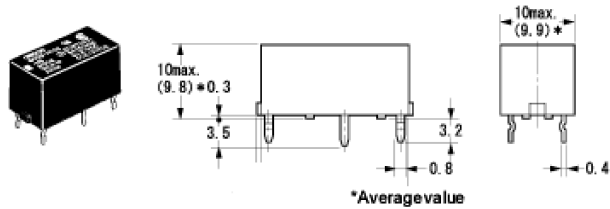

Terminal Arrangement / Internal Connections
(BOTTOM VIEW)
G6BK-1114P, -1114C

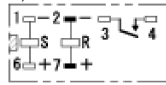

Mounting Holes
(BOTTOM VIEW)
G6BK-1114P, -1114C

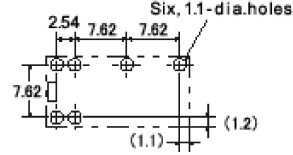

Back Connecting Socket
P6B-04P

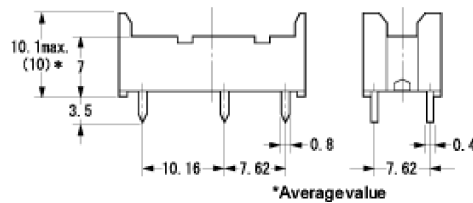
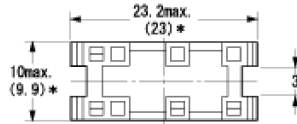
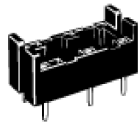

Mounting Holes
(BOTTOM VIEW)

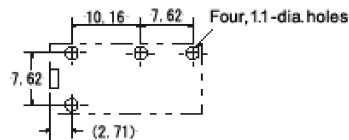

P6B-06P

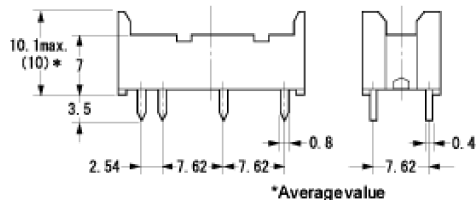
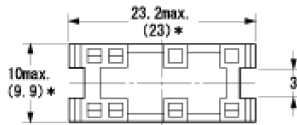
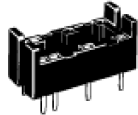

Mounting Holes
(BOTTOM VIEW)

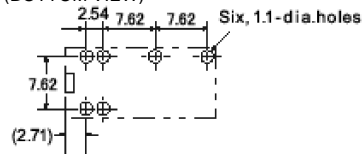

Removal Tool P6B-Y1



Hold-down Clips P6B-C2



Note: 1 P6B-C2 Hold-down Clips cannot be used for G6B-1174P-US.