

Datasheet

Blue Male 2P+E Right Angle Industrial Power Socket Rated At 16A,200 → 250 V

RS Stock number [517-7329](#)



Specifications:

Rated Current:	16A – 32A
Rated Voltage:	100÷690V ~
Frequency:	c.c. - 50÷500Hz
Insulating Voltage:	500/690V ~
Protection Degree:	IP44 – IP66/IP67
Operating temperature according to the reference standard:	-25°C + 40°C
Max. Operating Temperature:	60°C
Glow Wire Test:	650°C/850°C
Material:	Engineering plastic
IK Degree at 20°C:	IK07 – IK09
Cable Inlets:	Cable sleeve IP44 Cable gland IP66/IP67

PLUGS - IP44

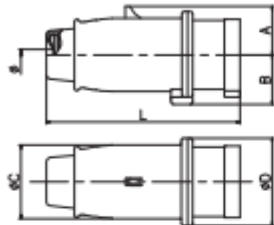

		A	B	C	D	L	ØMin.
16A	2P+E	30	31	44	53	128	7
	3P+E	34	35	50	59	135	7
	3P+N+E	38	38	57	68	150	9
32A	2P+E	40	38	57	68	159	9
	3P+E	40	38	57	68	159	9
	3P+N+E	45	42	62	75	166	10

PLUGS - IP66/IP67

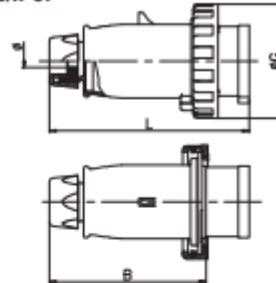

		ØG	B	L	ØMin.
16A	2P+E	73	98	132	8
	3P+E	81	105	139	8
	3P+N+E	88	121	155	10
32A	2P+E	93	121	164	10
	3P+E	93	121	164	10
	3P+N+E	101	130	173	14

PLUGS - ANGLED - IP44

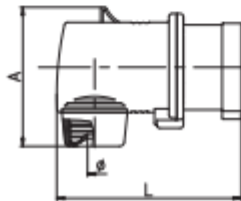

		A	L	ØMin.
16A	2P+E	70	109	7
	3P+E	77	113	7
	3P+N+E	88	117	9
32A	2P+E	90	135	9
	3P+E	90	135	9
	3P+N+E	100	135	10

PLUGS - ANGLED - IP66/IP67

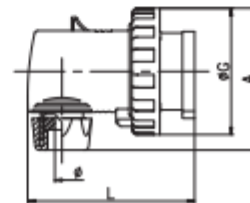

		A	L	ØG	ØMin.
16A	2P+E	80	109	73	8
	3P+E	88	113	81	8
	3P+N+E	100	117	88	10
32A	2P+E	100	135	93	10
	3P+E	100	135	93	10
	3P+N+E	108	140	101	14

CONNECTORS - IP44

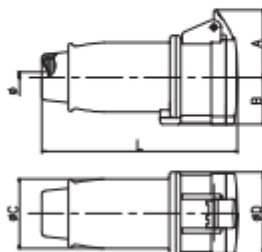

		A	B	C	D	L	ØMin.
16A	2P+E	46	31	44	53	137	7
	3P+E	49	34	50	60	144	7
	3P+N+E	55	39	57	68	160	9
32A	2P+E	55	39	57	68	170	9
	3P+E	55	39	57	68	170	9
	3P+N+E	61	43	63	75	178	10

CONNECTORS - IP66/IP67

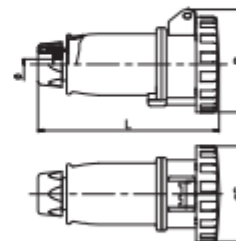

		ØG	B	L	ØMin.
16A	2P+E	78	75	144	8
	3P+E	81	83	150	8
	3P+N+E	88	95	168	10
32A	2P+E	93	102	178	10
	3P+E	93	102	178	10
	3P+N+E	101	102	187	14

(Dimensions in mm)

CONNECTORS - ANGLED - IP44

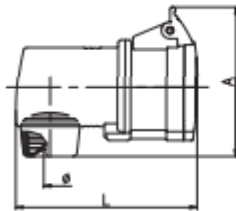

		A	L	ØMin.
16A	2P+E	89	117	7
	3P+E	95	122	7
	3P+N+E	108	127	9
32A	2P+E	110	146	9
	3P+E	110	146	9
	3P+N+E	120	152	10

CONNECTORS - ANGLED - IP66/IP67

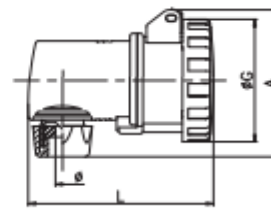

		A	L	ØG	ØMin.
16A	2P+E	78	120	73	8
	3P+E	86	125	81	8
	3P+N+E	106	130	88	10
32A	2P+E	106	150	93	10
	3P+E	106	150	93	10
	3P+N+E	107	155	101	14

APPLIANCE INLETS - 90° ANGLED - IP44

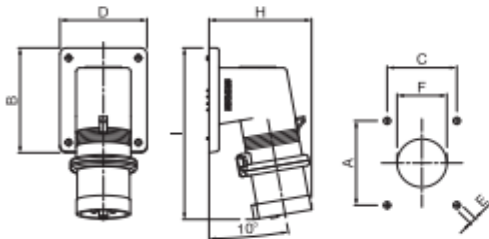

		A	B	C	D	E	F	H	I
16A	2P+E	70	87	56	70	5.2	40	83	142
	3P+E	70	87	56	70	5.2	40	91	143
	3P+N+E	70	87	56	70	5.2	40	97	144
32A	2P+E	70	87	56	70	5.2	40	99	153
	3P+E	70	87	56	70	5.2	40	99	153
	3P+N+E	70	87	56	70	5.2	40	107	154

APPLIANCE INLETS - 90° ANGLED - IP66/IP67

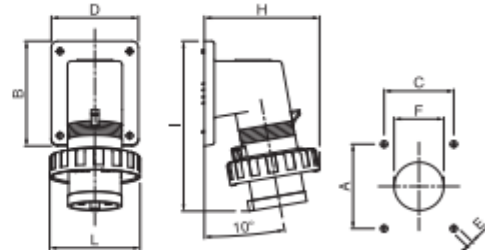

		A	B	C	D	E	F	H	I	L
16A	2P+E	70	87	56	70	5.2	40	93	142	73
	3P+E	70	87	56	70	5.2	40	102	143	81
	3P+N+E	70	87	56	70	5.2	40	109	144	88
32A	2P+E	70	87	56	70	5.2	40	111	153	93
	3P+E	70	87	56	70	5.2	40	111	153	93
	3P+N+E	70	87	56	70	5.2	40	120	154	101

SOCKETS OUTLET - 90° ANGLED - IP44

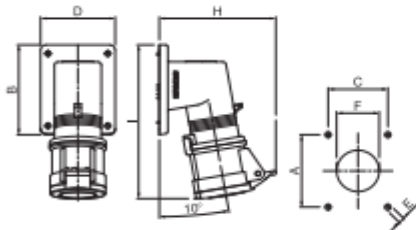

		A	B	C	D	E	F	H	I
16A	2P+E	70	87	56	70	5.2	40	109	149
	3P+E	70	87	56	70	5.2	40	116	150
	3P+N+E	70	87	56	70	5.2	40	125	151
32A	2P+E	70	87	56	70	5.2	40	127	161
	3P+E	70	87	56	70	5.2	40	127	161
	3P+N+E	70	87	56	70	5.2	40	137	163

SOCKETS OUTLET - 90° ANGLED - IP66/IP67

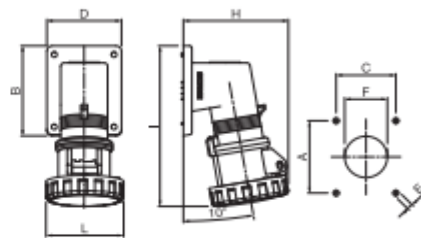

		A	B	C	D	E	F	H	I	L
16A	2P+E	70	87	56	70	5.2	40	98	155	73
	3P+E	70	87	56	70	5.2	40	107	156	81
	3P+N+E	70	87	56	70	5.2	40	117	157	88
32A	2P+E	70	87	56	70	5.2	40	123	168	93
	3P+E	70	87	56	70	5.2	40	123	168	93
	3P+N+E	70	87	56	70	5.2	40	127	169	101

(Dimensions in mm)

**PANEL MOUNTING SOCKET OUTLETS ANGLED
IP44**

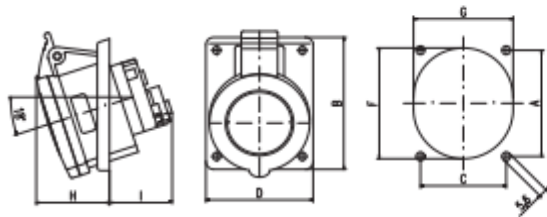

	A	B	C	D	F	G	H	I
2P+E	70	87	56	70	73	65	45	40
16A 3P+E	70	87	56	70	73	65	46	40
3P+N+E	70	87	56	70	73	65	48	41
2P+E	90	106	68	84	87	76	52	60
32A 3P+E	90	106	68	84	87	76	52	60
3P+N+E	90	106	68	84	87	76	54	61

**PANEL MOUNTING SOCKET OUTLETS - ANGLED
IP66/IP67**

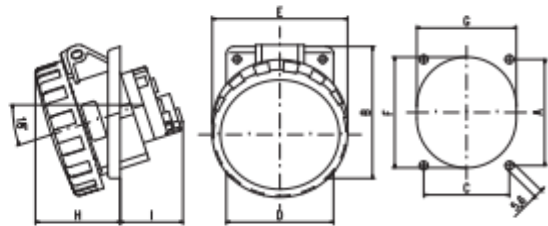

	A	B	C	D	E	F	G	H	I
2P+E	70	87	56	70	73	73	65	52	40
16A 3P+E	70	87	56	70	81	73	65	54	40
3P+N+E	70	87	56	70	88	73	65	55	41
2P+E	90	106	68	84	93	87	76	61	60
32A 3P+E	90	106	68	84	93	87	76	61	60
3P+N+E	90	106	68	84	101	87	76	63	61

**PANEL MOUNTING SOCKET OUTLETS - STRAIGHT
REDUCED FLANGE - IP44**

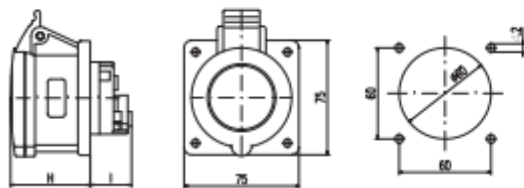

	I	H
2P+E	27	51
16A 3P+E	27	51
3P+N+E	27	52
2P+E	42	62
32A 3P+E	42	62
3P+N+E	42	63

**PANEL MOUNTING SOCKET OUTLETS - STRAIGHT
REDUCED FLANGE - IP66/IP67**

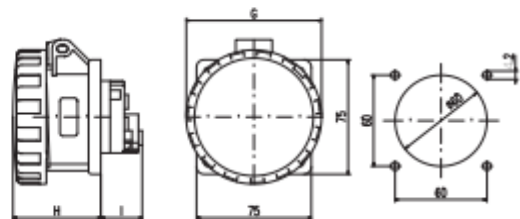

	G	H	I
2P+E	73	56	27
16A 3P+E	81	57	27
3P+N+E	88	58	27
2P+E	93	68	42
32A 3P+E	93	68	42
3P+N+E	101	69	42

(Dimensions in mm)

**SURFACE MOUNTING SOCKET OUTLETS
ANGLED BOX - >50V - IP44**

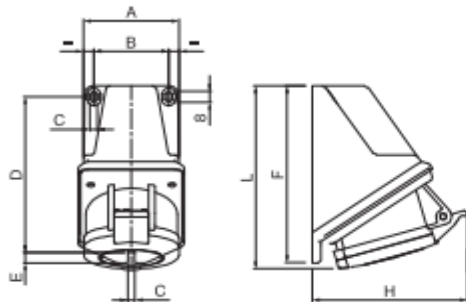

	A	B	C	D	E	F	H	L
2P+E	65	52	5	112	7.5	127	99	128
16A 3P+E	65	52	5	112	7.5	127	102	131
3P+N+E	65	52	5	112	7.5	127	107	133
2P+E	80	66	5	121	7.5	137	116	141
32A 3P+E	80	66	5	121	7.5	137	116	141
3P+N+E	80	66	5	121	7.5	137	120	143

**SURFACE MOUNTING SOCKET OUTLETS
ANGLED BOX - >50V - IP66/IP67**

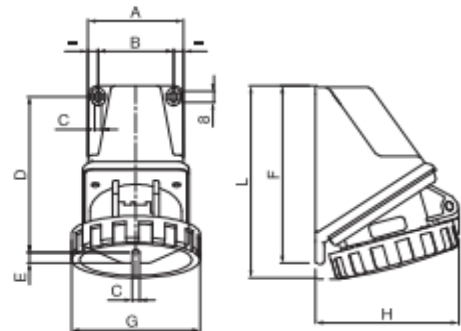

	A	B	C	D	E	F	G	H	I
2P+E	65	52	5	112	7.5	127	73	91	134
16A 3P+E	65	52	5	112	7.5	127	81	95	135
3P+N+E	65	52	5	112	7.5	127	88	96	136
2P+E	80	66	5	121	7.5	137	93	112	147
32A 3P+E	80	66	5	121	7.5	137	93	112	147
3P+N+E	80	66	5	121	7.5	137	101	113	149

**SURFACE MOUNTING SOCKET OUTLETS -
STRAIGHT BOX >50V - IP44**

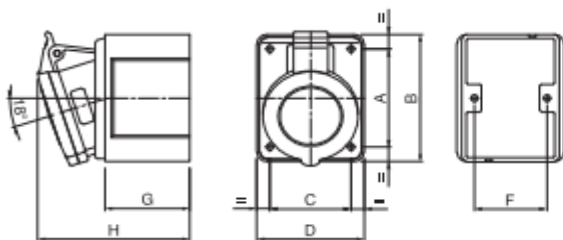

	A	B	C	D	F	G	H
2P+E	70	91	56	74	50	59	102
16A 3P+E	70	91	56	74	50	59	103
3P+N+E	70	91	56	74	50	59	105
2P+E	90	111	68	89	62	72	123
32A 3P+E	90	111	68	89	62	72	123
3P+N+E	90	111	68	89	62	72	125

**SURFACE MOUNTING SOCKET OUTLETS -
STRAIGHT BOX >50V - IP66/IP67**

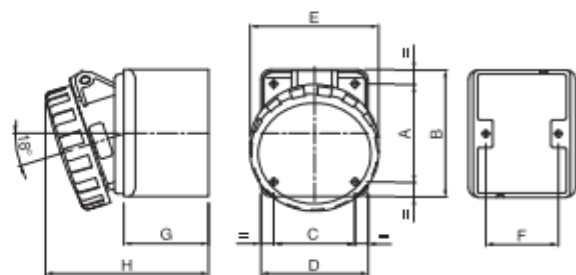

	A	B	C	D	E	F	G	H
2P+E	70	91	56	74	73	50	59	110
16A 3P+E	70	91	56	74	81	50	59	111
3P+N+E	70	91	56	74	88	50	59	113
2P+E	90	111	68	89	93	62	72	131
32A 3P+E	90	111	68	89	93	62	72	131
3P+N+E	90	111	68	89	101	62	72	134

(Dimensions in mm)