



Air-Conditioning Controllers



- anspruchsvolles Design/attractive design
- hohe Präzision/high precision
- robuste Zuverlässigkeit/robust reliability

KLR-E 7004



KLR-E 7006



Produktbeschreibung	KLR-E 7004	KLR-E 7006
Schalter	Netz EIN/AUS Lüfter schnell/mittel/langsam Heizen/Lüften/Kühlen	Netz EIN/AUS Lüfter schnell/mittel/langsam Heizen/Lüften/Kühlen
Switches	Mains ON/OFF Fan speed high/med/low Heat/Fan/Cool	Mains ON/OFF Fan speed high/med/low Heat/Fan/Cool
Ausgänge	Heizen Kühlen Lüfter schnell/mittel/langsam	Kompressor Umkehrventil (bei Heizen EIN) Lüfter schnell/mittel/langsam
Outputs	Heat Cool Fan speed high/med/low	Compressor Reverse valve (for heating on) Fan speed high/med/low
Anzeigelampen	Heizen Kühlen Netz EIN/AUS	Heizen Kühlen Netz EIN/AUS
Indication lamps	Heat Cool Mains ON/OFF	Heat Cool Mains ON/OFF

Technische Daten / Technical data	
Betriebsspannung Operating Voltage	AC 230 V/50/60 Hz
Schaltstrom Switching current	6 A $\cos\varphi = 1$ / 3 A $\cos\varphi = 0,6$
Kontakt Contact configuration	Wechsler SPDT
Temperaturbereich Temperature range	5...30°C
Hysterese/Hysteresis	~0,5 K
Temperaturfühler Temperature sensor	Bimetall
Schutzart/Schutzklasse Housing protection	IP 30/schutzisoliert IP 30/isolated
Bestell-Bezeichnung Type	KLR-E 7004
Artikel-Nr./article no.	111 7704 51 100

Schaltzeichnung / Wiring diagram

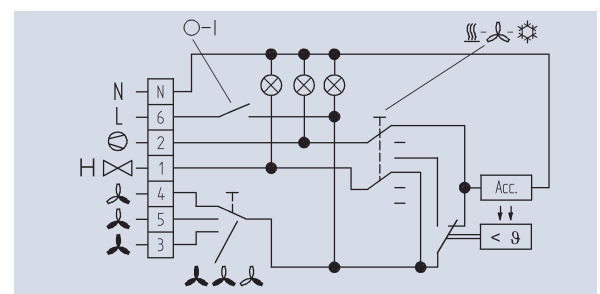
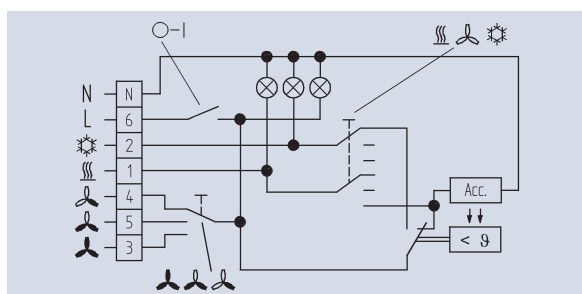



Produktbeschreibung	KLR-E 7007	KLR-E 7009
Schalter	Netz EIN/AUS Lüfter dauernd/automatisch Heizen/Lüften/Kühlen	Netz EIN/AUS Lüfter schnell/mittel/langsam
Switches	Mains ON/OFF Fan continuous/automatic Heat/Fan/Cool	Mains ON/OFF Fan speed high/med/low
Ausgänge	Heizen Kühlen Lüfter Kompressor Schalterausgang	Heizen Kühlen Lüfter schnell/mittel/langsam
Outputs	Heat Cool Fan Compressor Switch output	Heat Cool Fan speed high/med/low

Technische Daten / Technical data		
Betriebsspannung Operating Voltage	AC 24 V/AC 230 V/50/60 Hz	AC 230 V/50/60 Hz
Schaltstrom Switching current	6A cosφ = 1 / 3A cosφ = 0,6	6A cosφ = 1 / 3A cosφ = 0,6
Kontakt Contact configuration	Wechsler SPDT	Wechsler SPDT
Temperaturbereich Temperature range	5...30°C	5...30°C
Hysterese/Hysteresis	~0,5K	~0,5K
Temperaturfühler Temperature sensor	Bimetall	Bimetall
Schutzart/Schutzklasse Housing protection	IP 30/schutzisoliert IP 30/isolated	IP 30/schutzisoliert IP 30/isolated
Bestell-Bezeichnung Type	KLR-E 7007	KLR-E 7009
Artikel-Nr./article no.	111 7707 91 100	111 7709 51 100

Schaltzeichnung / Wiring diagram

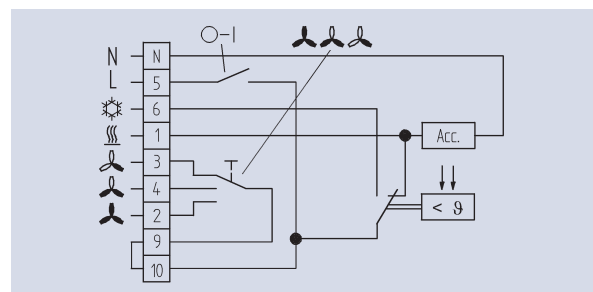
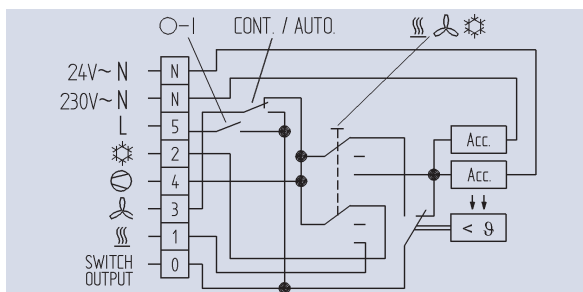

KLR-E 7010



KLR-E 7011



Produktbeschreibung	KLR-E 7010	KLR-E 7011
Schalter	Netz EIN/AUS Lüfter schnell/mittel/langsam Heizen/Kühlen	Netz EIN/AUS Lüfter schnell/mittel/langsam
Switches	Mains ON/OFF Fan speed high/med/low Heat/Fan/Cool	Mains ON/OFF Fan speed high/med/low
Ausgänge	Heizen/Kühlen Lüfter schnell/mittel/langsam	Heizen Kühlen Lüfter schnell/mittel/langsam
Outputs	Heat/Cool Fan speed high/med/low	Heat Cool Fan speed high/med/low

Technische Daten / Technical data		
Betriebsspannung Operating Voltage	AC 230 V/50/60 Hz	AC 230 V/50/60 Hz
Schaltstrom Switching current	6 A $\cos\varphi = 1$ / 3 A $\cos\varphi = 0,6$	6 A $\cos\varphi = 1$ / 3 A $\cos\varphi = 0,6$
Kontakt Contact configuration	Wechsler SPDT	Wechsler SPDT
Temperaturbereich Temperature range	5...30°C	5...30°C
Hysterese/Hysteresis	~0,5 K	~0,5 K
Temperaturfühler Temperature sensor	Bimetall	Bimetall
Schutzart/Schutzklasse Housing protection	IP 30/schutzisoliert IP 30/isolated	IP 30/schutzisoliert IP 30/isolated
Bestell-Bezeichnung Type	KLR-E 7010	KLR-E 7011
Artikel-Nr./article no.	111 7710 51 100	111 7711 51 100

Schaltzeichnung / Wiring diagram

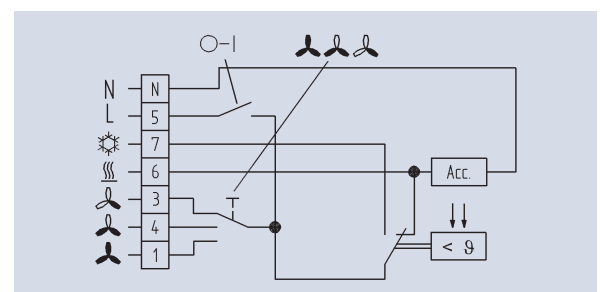
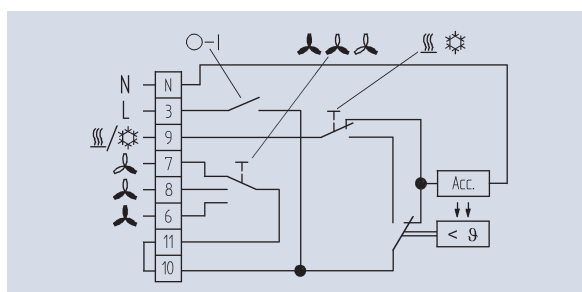

KLR-E 7012



KLR-E 7015



Produktbeschreibung	KLR-E 7012	KLR-E 7015
Schalter	Netz EIN/AUS Heizen/Kühlen	Netz EIN/AUS Heizen/Kühlen
Switches	Lüfter schnell/mittel/langsam Mains ON/OFF Heat/Cool Fan speed high/med/low	Lüfter schnell/mittel/langsam Mains ON/OFF Heat/Cool Fan speed high/med/low
Ausgänge	Heizen Kühlen Lüfter schnell/mittel/langsam	Lüfter schnell/mittel/langsam
Outputs	Heat Cool Fan speed low/med/high	Fan speed high/med/low

Technische Daten / Technical data		
Betriebsspannung Operating Voltage	AC 230 V/50/60 Hz	AC 230V/50/60 Hz
Schaltstrom Switching current	6 A $\cos \varphi = 1$ / 3 A $\cos \varphi = 0,6$	6 A $\cos \varphi = 1$ / 3 A $\cos \varphi = 0,6$
Kontakt Contact configuration	Wechsler SPDT	Wechsler SPDT
Temperaturbereich Temperature range	5...30°C	5...30°C
Hysterese/Hysteresis	~0,5 K	~0,5 K
Temperaturfühler Temperature sensor	Bimetall	Bimetall
Schutzart/Schutzklasse Housing protection	IP 30/schutzisoliert IP 30/isolated	IP 30/schutzisoliert IP 30/isolated
Bestell-Bezeichnung Type	KLR-E 7012	KLR-E 7015
Artikel-Nr./article no.	111 7712 51 100	111 7715 51 100

Schaltzeichnung / Wiring diagram

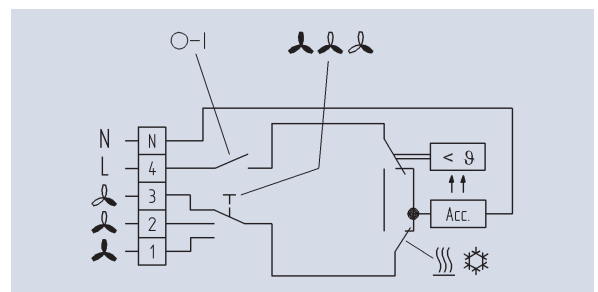
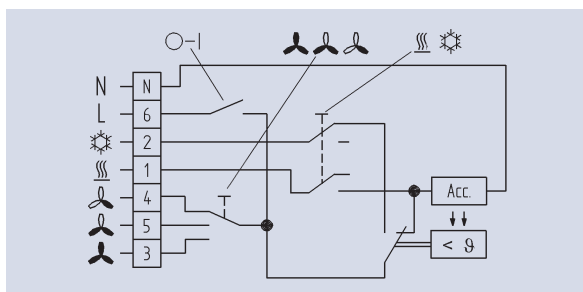

KLR-E 7017



KLR-E 7019



Produktbeschreibung	KLR-E 7017	KLR-E 7019
Schalter	Netz EIN/AUS Lüfter schnell/mittel/langsam Heizen/Lüften/Kühlen	Netz EIN/AUS Lüfter schnell/mittel/langsam
Switches	Mains ON/OFF Fan speed high/med/low Heat/Fan/Cool	Mains ON/OFF Fan speed high/med/low
Ausgänge	Heizen Kühlen Lüfter schnell/mittel/langsam	Kühlen Lüfter schnell/mittel/langsam
Outputs	Heat Cool Fan speed high/med/low	Eingang Temperaturanhebung Cool Fan speed high/med/low
Eingänge Inputs		Temperaturanhebung Temperature set up
Anzeigelampen	Heizen Kühlen Netz EIN/AUS	
Indication lamps	Heat Cool Mains ON/OFF	

Technische Daten / Technical data

Betriebsspannung/Operating Voltage	AC 230 V/50/60 Hz	AC 230 V/50/60 Hz
Schaltstrom/Switching current	6 A $\cos\varphi = 1$ / 3 A $\cos\varphi = 0,6$	6 A $\cos\varphi = 1$ / 3 A $\cos\varphi = 0,6$
Kontakt Contact configuration	Wechsler SPDT	Wechsler SPDT
Temperaturbereich Temperature range	5...30°C	5...30°C
Hysterese/Hysteresis	~0,5 K	~0,5 K
Temperaturanhebung Temperature set up	—	5 K
Temperaturfühler Temperature sensor	Bimetall	Bimetall
Schutzart/Schutzklasse Housing protection	IP 30/schutzisoliert IP 30/isolated	IP 30/schutzisoliert IP 30/isolated
Bestell-Bezeichnung/Type	KLR-E 7017	KLR-E 7019
Artikel-Nr./article no.	111 7717 51 100	111 7019 51 100

Schaltzeichnung / Wiring diagram

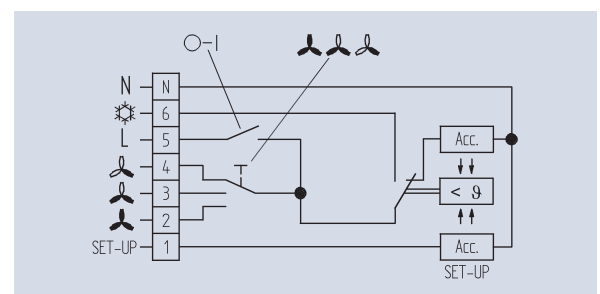
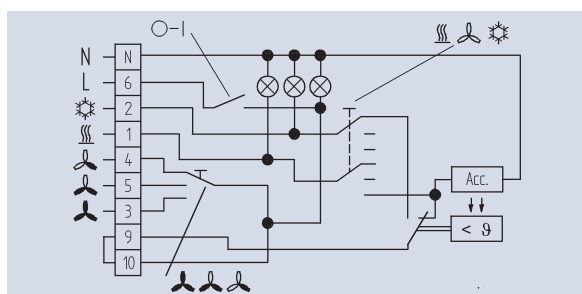

KLR-E 7026



KLR-E 7034



Produktbeschreibung	KLR-E 7026	KLR-E 7034
Schalter	Netz EIN/AUS Lüfter schnell/mittel/langsam	Netz EIN/AUS Lüfter schnell/mittel/langsam Heizen/Lüften/Kühlen
Switches	Mains ON/OFF Fan speed high/med/low	Mains ON/OFF Fan speed high/med/low Heat/Fan/Cool
Ausgänge	Kühlen Lüfter schnell/mittel/langsam	Heizen Kühlen Lüfter schnell/mittel/langsam
Outputs	Cool Fan speed high/med/low	Heat Cool Fan speed high/med/low
Anzeigelampen		Heizen Kühlen Netz EIN/AUS
Indication lamps		Heat Cool Mains ON/OFF

Technische Daten / Technical data		
Betriebsspannung Operating Voltage	AC 230 V/50/60 Hz	AC 230 V/50/60 Hz
Schaltstrom Switching current	6 A cosφ = 1 / 3 A cosφ = 0,6	6 A cosφ = 1 / 3 A cosφ = 0,6
Kontakt Contact configuration	Wechsler SPDT	Wechsler SPDT
Temperaturbereich Temperature range	5...30°C	5...30°C
Hysterese/Hysteresis	~0,5 K	~0,5 K
Temperaturfühler Temperature sensor	Bimetall	Bimetall
Schutzart/Schutzklasse Housing protection	IP 30/schutzisoliert IP 30/isolated	IP 30/schutzisoliert IP 30/isolated
Bestell-Bezeichnung/Type	KLR-E 7026	KLR-E 7034
Artikel-Nr./article no.	111 7026 51 100	111 7734 51 100

Schaltzeichnung / Wiring diagram

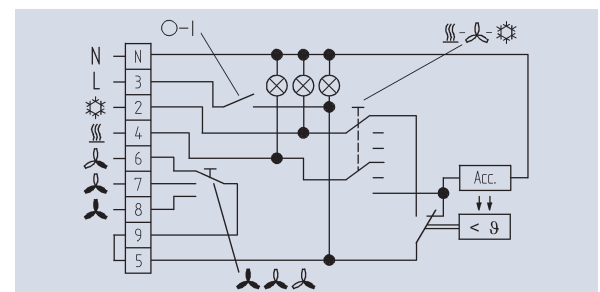
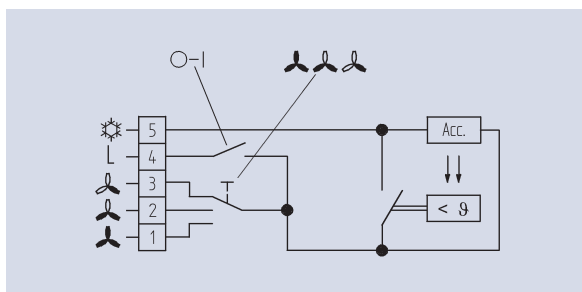

KLR-E 7038



KLR-E 7201



Produktbeschreibung	KLR-E 7038	KLR-E 7201
Schalter	Netz EIN/AUS Lüfter schnell/mittel/langsam Heizen/Kühlen	
Switches	Mains ON/OFF Fan speed high/med/low Heat/Cool	
Ausgänge	Heizen Kühlen Heizen / Kühlen	Heizen Kühlen
Outputs	Lüfter schnell/mittel/langsam Heat Cool Heat/Cool Fan speed high/med/low	Heat Cool

Technische Daten / Technical data		
Betriebsspannung Operating Voltage	AC 230 V/50/60 Hz	AC 230 V/50/60 Hz
Schaltstrom Switching current	6 A $\cos\varphi = 1$ / 3 A $\cos\varphi = 0,6$	10 A $\cos\varphi = 1$ / 4 A $\cos\varphi = 0,6$
Kontakt Contact configuration	Wechsler SPDT	Wechsler mit Neutralzone SPDT with neutral zone
Temperaturbereich Temperature range	5...30°C	5...30°C
Hysterese/Hysteresis	~0,5 K	~0,5 K
Neutralzone/Neutral zone	—	~2 K
Temperaturfühler Temperature sensor	Bimetall	NTC intern NTC internal
Schutzart/Schutzklasse Housing protection	IP 30/schutzisoliert IP 30/isolated	IP 30/schutzisoliert IP 30/isolated
Bestell-Bezeichnung Type	KLR-E 7038	KLR-E 7201
Artikel-Nr./article no.	111 7738 51 100	517 7201 51 100

Schaltzeichnung / Wiring diagram

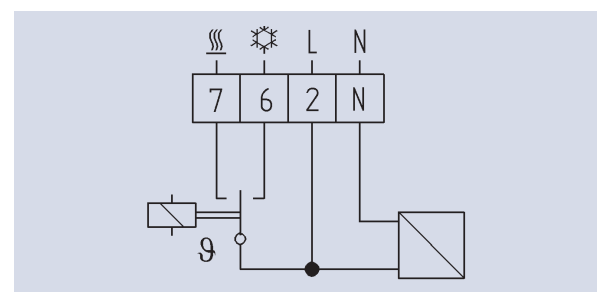
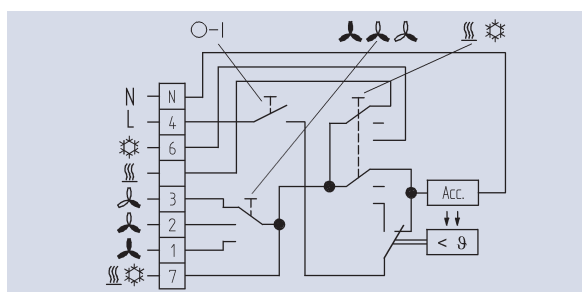

KLR-E 7202



KLR-E 7203



Produktbeschreibung	KLR-E 7202	KLR-E 7203
Schalter	Netz EIN/AUS	Netz EIN/AUS
Switches	Mains ON/OFF	Lüfter schnell/mittel/langsam Mains ON/OFF Fan speed high/med/low
Ausgänge	Heizen Kühlen Schalterausgang	Heizen Kühlen Lüfter schnell/mittel/langsam
Outputs	Heat Cool Switch output	Heat Cool Fan speed high/med/low

Technische Daten / Technical data		
Betriebsspannung Operating Voltage	AC 230 V/50/60 Hz	AC 230 V/50/60 Hz
Schaltstrom Switching current	10 A $\cos\varphi = 1$ / 4 A $\cos\varphi = 0,6$	6 A $\cos\varphi = 1$ / 3 A $\cos\varphi = 0,6$ / 10 A $\cos\varphi = 1$ / 4 A $\cos\varphi = 0,6$
Kontakt Contact configuration	Wechsler mit Neutralzone SPDT with neutral zone	Wechsler mit Neutralzone SPDT with neutral zone
Temperaturbereich Temperature range	5...30°C	5...30°C
Hysterese/Hysteresis	~0,5 K	~0,5 K
Neutralzone/Neutral zone	~2 K	~2 K
Temperaturfühler Temperature sensor	NTC intern NTC internal	NTC intern NTC internal
Schutzart/Schutzklasse Housing protection	IP 30/schutzisoliert IP 30/isolated	IP 30/schutzisoliert IP 30/isolated
Bestell-Bezeichnung Type	KLR-E 7202	KLR-E 7203
Artikel-Nr./article no.	517 7202 51 100	517 7203 51 100

Schaltzeichnung / Wiring diagram

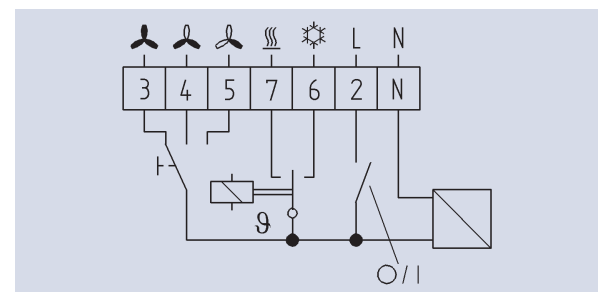
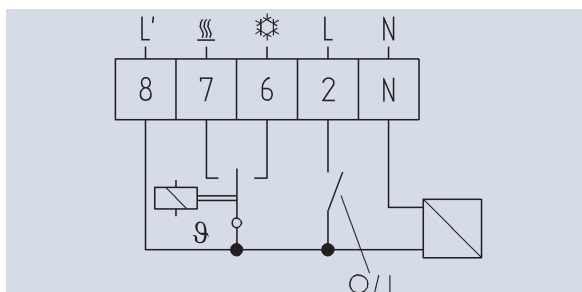

KLR-E 7204



KLR-E 7222



Produktbeschreibung	KLR-E 7204	KLR-E 7222
Schalter	Netz EIN/AUS Lüfter schnell/mittel/langsam	Netz EIN/AUS Lüfter schnell/mittel/langsam
Switches	Mains ON/OFF Fan speed high/med/low	Mains ON/OFF Fan speed high/med/low
Ausgänge	Heizen Kühlen Lüfter schnell/mittel/langsam	Heizen Kühlen Lüfter schnell/mittel/langsam
Outputs	Heat Cool Fan speed high/med/low	Heat Cool Fan speed high/med/low
Anzeigelampen	Netz EIN/AUS Kühlen Heizen	
Indication lamps	Mains ON/OFF Cool Heat	

Technische Daten / Technical data

Betriebsspannung Operating Voltage	AC 230 V/50/60 Hz	AC 230 V/50/60 Hz
Schaltstrom Switching current	6A cosφ = 1/3A cosφ = 0,6 10A cosφ = 1/4A cosφ = 0,6	6A cosφ = 1/3A cosφ = 0,6 10A cosφ = 1/4A cosφ = 0,6
Kontakt Contact configuration	Wechsler mit Neutralzone SPDT with neutral zone	Wechsler mit Neutralzone SPDT with neutral zone
Temperaturbereich Temperature range	5...30°C	5...30°C
Hysterese/Hysteresis	~0,5 K	~0,5 K
Neutralzone/Neutral zone	~2 K	~2 K
Temperaturfühler Temperature sensor	NTC intern NTC internal	NTC intern NTC internal
Schutzart/Schutzklasse Housing protection	IP 30/schutzisoliert IP 30/isolated	IP 30/schutzisoliert IP 30/isolated
Bestell-Bezeichnung Type	KLR-E 7204	KLR-E 7222
Artikel-Nr./article no.	517 7204 51 100	517 7220 51 100

Schaltzeichnung / Wiring diagram

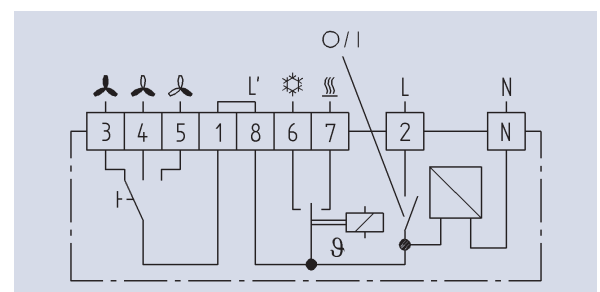
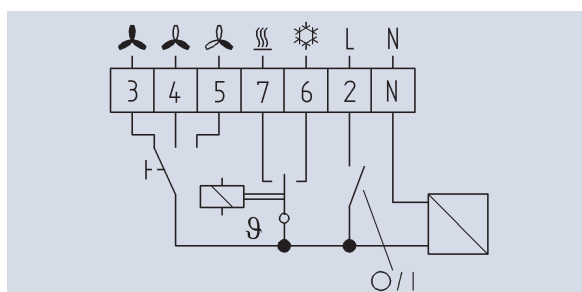

KLR-E 7430



KLR-E 7434



Produktbeschreibung	KLR-E 7430	KLR-E 7434
Schalter	Netz EIN/AUS Lüfter schnell/mittel/langsam Lüfter dauernd/automatisch Heizen/Lüften/Kühlen	Netz EIN/AUS Lüfter schnell/mittel/langsam Lüfter dauernd/automatisch Heizen/Lüften/Kühlen
Switches	Mains ON/OFF Fan speed high/med/low Fan continuous/automatic Heat/Fan/Cool	Mains ON/OFF Fan speed high/med/low Fan continuous/automatic Heat/Fan/Cool
Ausgänge	Heizen Kühlen Lüfter schnell/mittel/langsam Kompressor	Heizen Kühlen Lüfter schnell/mittel/langsam Kompressor
Outputs	Heat Cool Fan speed high/med/low Compressor	Heat Cool Fan speed high/med/low Compressor

Technische Daten / Technical data		
Betriebsspannung Operating Voltage	AC 230 V/50/60 Hz	AC 230 V/50/60 Hz
Schaltstrom Switching current	6 A cosφ = 1 / 3 A cosφ = 0,6	6 A cosφ = 1 / 3 A cosφ = 0,6
Kontakt Contact configuration	Wechsler SPDT	Wechsler SPDT
Temperaturbereich Temperature range	5...30°C	5...30°C
Hysterese/Hysteresis	~0,5 K	~0,5 K
Temperaturfühler Temperature sensor	Bimetall	Bimetall
Schutzart/Schutzklasse Housing protection	IP 30/schutzisoliert IP 30/isolated	IP 30/schutzisoliert IP 30/isolated
Bestell-Bezeichnung Type	KLR-E 7430	KLR-E 7434
Artikel-Nr./article no.	111 7730 51 100	111 7754 51 100

Schaltzeichnung / Wiring diagram

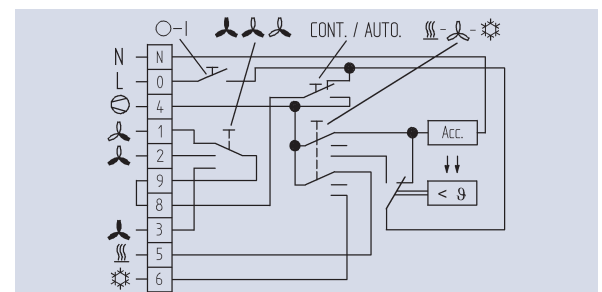
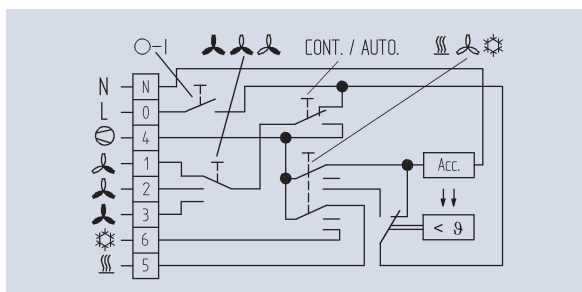

KLR-E 7603



KLR-E 7611



Produktbeschreibung	KLR-E 7603	KLR-E 7611
Schalter Switches		Netz EIN/AUS Mains ON/OFF
Ausgänge Outputs	Kompressor Umkehrventil (bei Heizen EIN) Compressor Reverse valve (for Heating ON)	Kompressor Umkehrventil (bei Heizen EIN) Compressor Reverse valve (for Heating ON)

Technische Daten / Technical data		
Betriebsspannung Operating Voltage	AC 230 V/50/60 Hz	AC 230 V/50/60 Hz
Schaltstrom Switching current	10 A $\cos\varphi = 1$ / 4 A $\cos\varphi = 0,6$	10 A $\cos\varphi = 1$ / 4 A $\cos\varphi = 0,6$
Kontakt Contact configuration	Wechsler mit Neutralzone SPDT with neutral zone	Wechsler mit Neutralzone SPDT with neutral zone
Temperaturbereich Temperature range	5...30 °C	5...30 °C
Hysterese/Hysteresis	~0,5 K	~0,5 K
Neutralzone/Neutral zone	~2 K	~2 K
Temperaturfühler Temperature sensor	NTC intern NTC internal	NTC intern NTC internal
Schutzart/Schutzklasse Housing protection	IP 30/schutzisoliert IP 30/isolated	IP 30/schutzisoliert IP 30/isolated
Bestell-Bezeichnung Type	KLR-E 7603 hp	KLR-E 7611
Artikel-Nr./article no.	517 7241 51 100	517 7243 51 100

Schaltzeichnung / Wiring diagram

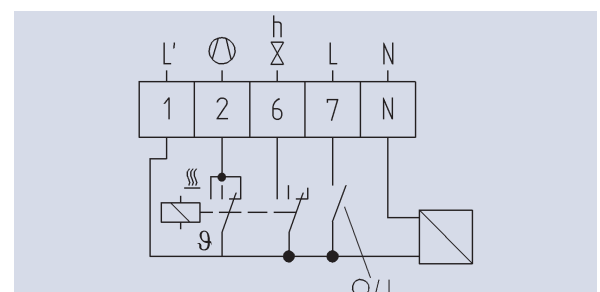
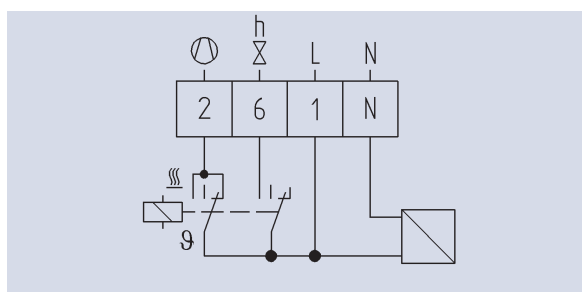

KLR-E 52552 4p



KLR-E 52552 hp



Produktbeschreibung	KLR-E 52552 4p	KLR-E 52552 hp
Schalter	Netz EIN/AUS Lüfter schnell/mittel/langsam	Netz EIN/AUS Lüfter schnell/mittel/langsam
Switches	Mains ON/OFF Fan speed high/med/low	Mains ON/OFF Fan speed high/med/low
Ausgänge	Heizen Kühlen Lüfter schnell/mittel/langsam	Kompressor Umkehrventil (bei Heizen EIN) Lüfter schnell/mittel/langsam
Outputs	Heat Cool Fan speed high/med/low Remote sensor	Compressor Reverse valve (for Heating ON) Fan speed high/med/low Remote sensor
Eingänge	Fernfühler	Fernfühler
Inputs	Remote sensor	Remote sensor
Anzeigelampen	Heizen Kühlen Netz EIN/AUS	Netz EIN/AUS
Indication lamps	Heat Cool Mains ON/OFF	Mains ON/OFF

Technische Daten / Technical data	
Betriebsspannung/Operating Voltage	AC 230 V/50/60 Hz
Schaltstrom	6 A $\cos\varphi = 1/3$ A $\cos\varphi = 0,6$
Switching current	10 A $\cos\varphi = 1/4$ A $\cos\varphi = 0,6$
Kontakt	Wechsler mit Neutralzone
Contact configuration	SPDT with neutral zone
Temperaturbereich	5...30°C
Temperature range	5...30°C
Hysterese/Hysteresis	~0,5 K
Neutralzone/Neutral zone	~0,5...8,5 K
Temperaturfühler	NTC intern
Temperature sensor	NTC internal
Fernfühler	F 193 720 oder F 190 021 optional
Remote sensor	F 193 720 or F 190 021 optional
Bestell-Bezeichnung/Type	KLR-E 52552 4p
Artikel-Nr./article no.	517 7210 51 100

Schaltzeichnung / Wiring diagram

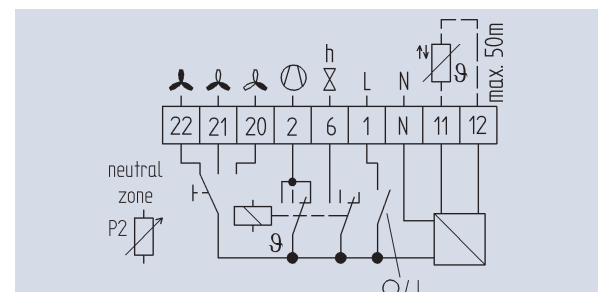
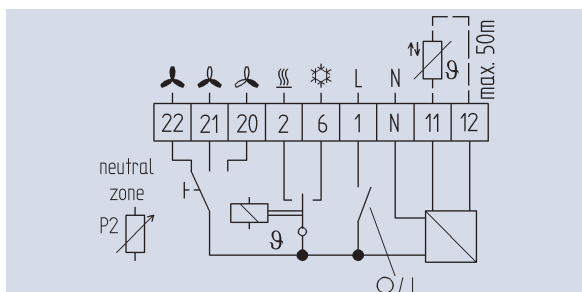

KLR-E 527 21



KLR-E 527 22



Produktbeschreibung	KLR-E 527 21	KLR-E 527 22
Schalter	Netz EIN/AUS	Lüfter schnell/mittel/langsam
Switches	Lüfter schnell/mittel/langsam Mains ON/OFF Fan speed high/med/low	Heizen/Lüften/Kühlen/Aus Fan speed high/med/low Heat/Fan/Cool/Off
Ausgänge	Heizen Kühlen Lüfter schnell/mittel/langsam	Heizen Kühlen Lüfter schnell/mittel/langsam
Outputs	Heat Cool Fan speed high/med/low	Heat Cool Fan speed high/med/low
Eingänge	Fernfühler Heizen/Kühlen-Umschaltung	Fernfühler
Inputs	Remote sensor Heat/Cool change over	Remote sensor

Technische Daten / Technical data	
Betriebsspannung Operating Voltage	AC 230 V/50/60 Hz
Schaltstrom Switching current	⚡ 6A $\cos\varphi = 1$ / 3A $\cos\varphi = 0,6$ ⚡ / ⚡ 3A $\cos\varphi = 1$ / 2A $\cos\varphi = 0,6$
Kontakt Contact configuration	Wechsler SPDT
Temperaturbereich Temperature range	5...30°C
Hysterese/Hysteresis	~0,5 K
Temperaturfühler Temperature sensor	NTC intern NTC internal
Schutzart/Schutzklasse Housing protection	IP 30/schutzisoliert IP 30/isolated
Fernfühler Remote sensor	F 193 720 oder F 190 021 optional F 193 720 or F 190 021 optional
Bestell-Bezeichnung Type	KLR-E 527 21
Artikel-Nr./article no.	515 7701 51 100

Schaltzeichnung / Wiring diagram

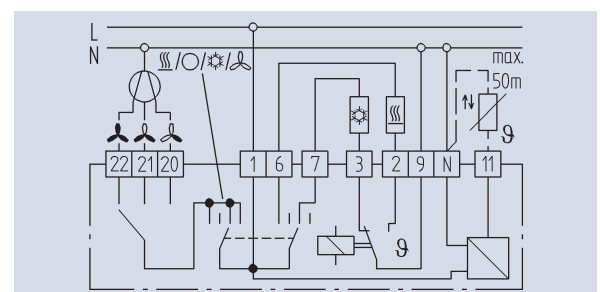
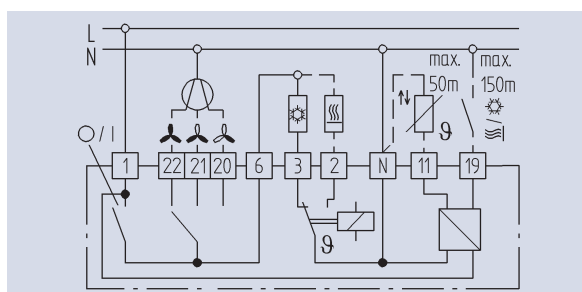

KLR-E 527 23



KLR-E 527 24



Produktbeschreibung	KLR-E 527 23	KLR-E 527 24
Schalter	Netz EIN/AUS Lüfter schnell/mittel/langsam	Lüfter schnell/mittel/langsam
Switches	Mains ON/OFF Fan speed high/med/low	Heizen/Lüften/Kühlen/Aus Fan speed high/med/low Heat/Fan/Cool/Off
Ausgänge	Heizen Kühlen Lüfter schnell/mittel/langsam	Heizen Kühlen Lüfter schnell/mittel/langsam
Outputs	Heat Cool Fan speed high/med/low	Heat Cool Fan speed high/med/low
Eingänge	Fernfühler Heizen/Kühlen-Umschaltung	Fernfühler
Inputs	Remote sensor Heat/Cool change over	Remote sensor

Technische Daten / Technical data	
Betriebsspannung Operating Voltage	AC 230 V/50/60 Hz
Schaltstrom Switching current	$6A \cos\varphi = 1 / 3A \cos\varphi = 0,6$ $3A \cos\varphi = 1 / 2A \cos\varphi = 0,6$
Kontakt Contact configuration	Wechsler SPDT
Temperaturbereich Temperature range	5...30°C
Hysterese/Hysteresis	~0,5K
Temperaturfühler Temperature sensor	NTC intern NTC internal
Schutzart/Schutzklasse Housing protection	IP 30/schutzisoliert IP 30/isolated
Fernfühler Remote sensor	F 193 720 oder F 190 021 optional F 193 720 or F 190 021 optional
Bestell-Bezeichnung Type	KLR-E 527 23
Artikel-Nr./article no.	517 7701 51 100

Schaltzeichnung / Wiring diagram

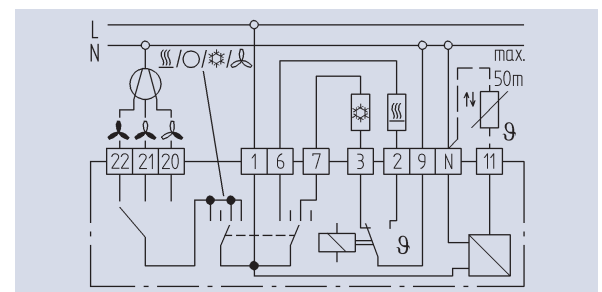
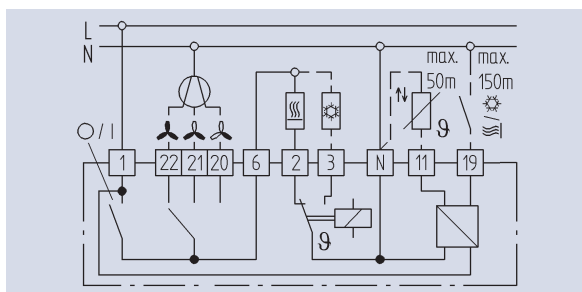

RTR-E 7712



RTR-E 525 50



Produktbeschreibung	RTR-E 7712	RTR-E 525 50
Schalter	Netz EIN/AUS Zusatzheizung	Heizen Stufe 2
Switches	Mains ON/OFF Auxiliary heating	Heating stage 2
Ausgänge	Heizen Stufe 1 Heizen Stufe 2 Zusatzheizung	Heizen Stufe 1 Heizen Stufe 2
Outputs	Heating stage 1 Heating stage 2 Auxiliary heating	Heating stage 1 Heating stage 2
Anzeigelampen	Zusatzheizung	Heizen Stufe 1 Heizen Stufe 2 Service
Indication lamps	Auxiliary heating	Heating Stage 1 Heating Stage 2 Service
Technische Daten / Technical data		
Betriebsspannung Operating Voltage	AC 230 V/50/60 Hz	AC 230 V/50/60 Hz
Schaltstrom Switching current	\sum 10 A $\cos\varphi = 1$ / 4 A $\cos\varphi = 0,6$ \sum 10 A $\cos\varphi = 1$ / 4 A $\cos\varphi = 0,6$ \sum max. 10 A	10 A $\cos\varphi = 1$ / 4 A $\cos\varphi = 0,6$
Kontakt Contact configuration	2-Stufen-Relais 2-Stages-relay	2-Stufen-Relais 2-stage-relays
Temperaturbereich Temperature range	5...30°C	5...30°C
Hysterese / Hysteresis	~0,5 K	~0,5 K
Stufenabstand / Stages gap	~1 K	~1 K
Temperaturfühler Temperature sensor	NTC intern NTC internal	NTC intern NTC internal
Schutzart/Schutzklasse Housing protection	IP 30/schutzisoliert IP 30/isolated	IP 30/schutzisoliert IP 30/isolated
Bestell-Bezeichnung / Type	RTR-E 7712	RTR-E 525 50
Artikel-Nr./article no.	517 7290 51 100	517 7285 51 100

Schaltzeichnung / Wiring diagram

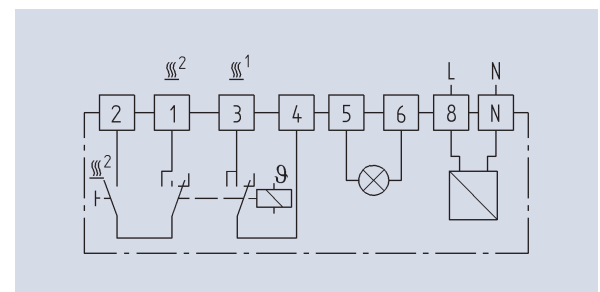
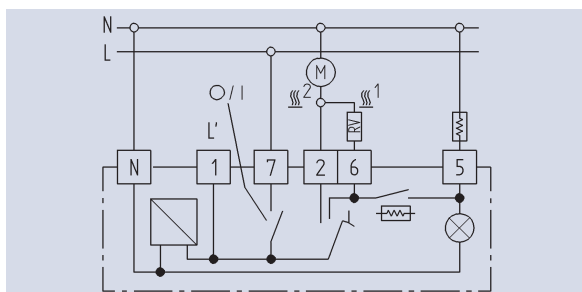

KLR-E 7037



F 190 021



F 193 720



Produktbeschreibung		KLR-E 7037	F 190 021	
		Zur Steuerung von Fenstern oder Beschattungseinrichtungen To control windows or shading equipments		Fernfühler Remote sensor
Schalter		Auf/Zu Auto/Hand	Schutzart Protection class	IP 30
Switches		Open/Close Auto/Manual	Betriebstemperatur Operating temperature	-25...+70°C
Ausgänge		Auf Zu	Maße Dimensions	75 x 75 x 25,5 mm
Outputs		Open Close	Bestell-Bezeichnung Type	F 190 021
			Artikel-Nr. article no.	000 190 021 000
Technische Daten / Technical data		F 193 720		
Betriebsspannung Operating Voltage	AC 230 V/50/60 Hz			Fernfühler Remote sensor
Schaltstrom Switching current	6 A cosφ = 1 / 3 A cosφ = 0,6			Schutzart Protection class
Kontakt Contact configuration	Wechsler SPDT			Betriebstemperatur Operating temperature
Hysterese/Hysteresis	~3 K/~7 K			Fühlerleitung Sensor cable
Temperaturbereich Temperature range	5...30°C			Bestell-Bezeichnung Type
Temperaturfühler Temperature sensor	Bimetall			Artikel-Nr. article no.
Schutzart/Schutzklasse Housing protection	IP 30/schutzisoliert IP 30/isolated			
Bestell-Bezeichnung Type	KLR-E 7037			
Artikel-Nr./article no.	111 7737 51 102			

Schaltzeichnung / Wiring diagram

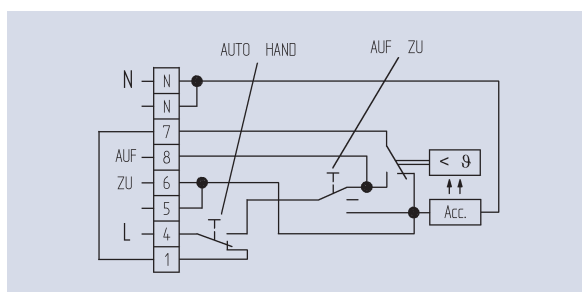

ARA 1.7 E



SGH 473



Produktbeschreibung	ARA 1.7 E	SGH 473
	Adapterrahmen Mounting plate	Schutzgehäuse Protection housing
	Zur Montage von Regelgeräten auf nahezu alle international verwendeten UP-Dosen For mounting of controllers onto nearly all flush mounted conduit boxes	Transparentes Aufputzgehäuse, abschließbar, mit Lüftungsschlitzen Transparent wall mounted housing, lockable, with ventilation slit
Bestellbezeichnung Type	ARA 1,7 E	SGH 473
Artikel-Nr./article no.	007 632 488 001	473 051 000 006
Bestellbezeichnung Type	Schraubensatz SS 00 1 Screw set SS 00 1	
Artikel-Nr./article no.	007 10 3188 001	

Maße / Dimensions

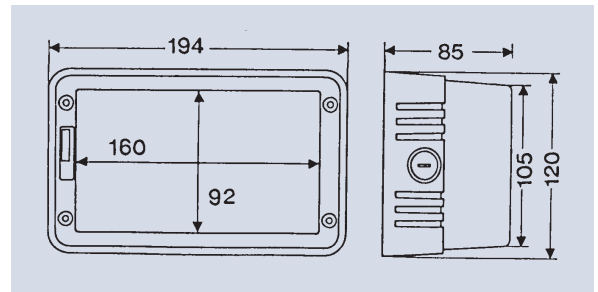
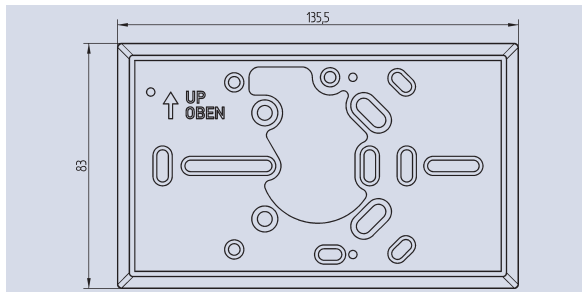

Maße / Dimensions

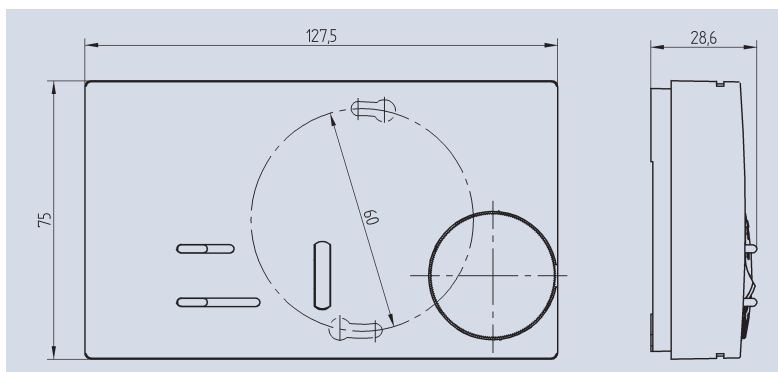

Typ Type	2-Rohr 2-pipe	4-Rohr 4-pipe	nur Kühlen Cooling only	Kühlen + elektr. Heizen Cooling + electr. heating	Wärmepumpe Heat pump	Lüftungs- systeme Ventilation	
7004		++		++			
7006				+	++		
7007		++		++	++		
7009	++		++				
7010	++						
7011	++	+	++			+	
7012		++		++			
7015	+	+				+	
7017		++		++			
7019			++				
7026			++				
7034		++		++			
7038	++	++		++			
7201		++					
7202		++					
7203		++				+	
7204		++				+	
7222		++				+	
7430		++		++	++	+	
7434		++		++	++	+	
7603					++		
7611					++		
525 52 4p	++	++	+	++		+	
525 52 hp					++	+	
527 21	++					+	
527 22		++			+	+	
527 23	++					+	
527 24		++			+	+	
525 58							Kühldecke Cool ceiling
7610							2-stufig Heizen 2 stage heating
7712							2-stufig Heizen mit Zusatzheizung 2 stage heating with auxiliary heating
52550							2-stufig Heizen 2 stage heating
7037							Wintergarten Winter garden

* nur in Verbindung mit einem Rohranlegeregler (z.B. RAR)

* to use with cylinder thermostat (e.g. RAR)



EBERLE Controls GmbH

P.O. Box 13 01 53 D-90113 Nürnberg
Klingenhofstraße 71 D-90411 Nürnberg
Tel +49(0)911 56 93 0 Fax +49(0)911 56 93 536
Email: info.eberle@climate.invensys.com
www.climate-eu.invensys.com