

Flush-type connector - SACC-CI-M12FS-8CON-L90 SH SCO - 1437009

Please be informed that the data shown in this PDF Document is generated from our Online Catalog. Please find the complete data in the user's documentation. Our General Terms of Use for Downloads are valid (<http://phoenixcontact.com/download>)



Sensor/actuator flush-type connector, socket, 8-pos., A-coded, shielded, with angled solder connection, only contact insert



Key commercial data

Packing unit	20 pc
Minimum order quantity	20 pc
GTIN	 4 046356 438575
Weight per Piece (excluding packing)	5.3 g
Custom tariff number	85366990
Country of origin	Germany

Technical data

Ambient conditions

Ambient temperature (operation)	-25 °C ... 85 °C (Plug / socket)
	-40 °C ... 85 °C (without mechanical actuation)
Degree of protection	IP67

General

Note	The electrical and mechanical data specified assume that the connector pair is correctly locked and mounted. If the connector is unlocked and if there is a danger of contamination, the connector must be sealed using a protective cap > IP54. Influences arising from litz wires, cables or PCB assembly must also be taken into consideration.
Rated current at 40°C	2 A
Rated voltage	30 V
Number of positions	8
Contact resistance	≤ 3 mΩ
Insulation resistance	≥ 100 MΩ
Coding	A - standard
Standards/regulations	M12 connector IEC 61076-2-101

Flush-type connector - SACC-CI-M12FS-8CON-L90 SH SCO - 1437009

Technical data

General

Status display	No
Surge voltage category	II
Pollution degree	3
Connection method	Solder pins
Insertion/withdrawal cycles	> 100
Torque	3 Nm ... 4 Nm (Installation-side)
Mounting type	PCB mounting

Material

Inflammability class according to UL 94	V0
Contact material	CuZn
Contact surface material	Au
Contact carrier material	PA 66
Sealing material	FKM / EPDM

Cable

Conductor cross section	0.25 mm ²
Conductor structure signal line	14x 0.15 mm
Core diameter including insulation	1.15 mm ±0.07 mm
Thickness, insulation	0.21 mm
Insulation resistance	≥ 20 MΩ*km
Conductor resistance	≤ 57.6 mΩ/m
Nominal voltage, cable	300 V
Test voltage, cable	2000 V AC
Ambient temperature (operation)	-40 °C ... 85 °C (cable, fixed installation)
	-25 °C ... 85 °C (cable, flexible installation)

Classifications

eCl@ss

eCl@ss 4.0	27060306
eCl@ss 4.1	27060306
eCl@ss 5.0	27061801
eCl@ss 5.1	27260701
eCl@ss 6.0	27279220
eCl@ss 7.0	27440103
eCl@ss 8.0	27440103

ETIM

ETIM 3.0	EC002061
ETIM 4.0	EC002061
ETIM 5.0	EC002061

Flush-type connector - SACC-CI-M12FS-8CON-L90 SH SCO - 1437009

Classifications

UNSPSC

UNSPSC 6.01	31251501
UNSPSC 7.0901	31251501
UNSPSC 11	31251501
UNSPSC 12.01	31251501
UNSPSC 13.2	31251501

Approvals

Approvals

Approvals

UL Recognized / EAC

Ex Approvals

Approvals submitted

Approval details

UL Recognized	
mm ² /AWG/kcmil	26-20
Nominal current I _N	2 A
Nominal voltage U _N	30 V

EAC

Accessories

Accessories

Panel mounting base

Housing screw connection - SACC-M12-SCO NUT - 1552243



M12 SPEEDCON housing screw connection for M12 female inserts, with O-ring, for all SPEEDCON-capable THR and wave soldering contact carriers

Flush-type connector - SACC-CI-M12FS-8CON-L90 SH SCO - 1437009

Accessories

Housing screw connection - SACC-M12-SCO NUT L 90 - 1432460



M12-SPEEDCON housing screw connection for M12 female inserts, with flat gasket, for all Speedcon-compatible THR and wave soldering contact carriers

Housing screw connection - SACC-M12 NUT PRESS - 1437889



Housing screw connection for two-piece M12 connectors for the reflow soldering process.

Protective cap

Screw plug - PROT-M12 - 1680539



An M12 screw plug for the unoccupied M12 sockets of the sensor/actuator cable, boxes and flush-type connectors

Screw plug - PROT-M12 SH - 1503302



An M12 screw plug for the unoccupied M12 sockets of the shielded sensor/actuator cable, boxes and flush-type connectors

Screw plug - PROT-M12 FB - 1555538



M12 high-grade steel screw plug, for unoccupied M12 sockets of the sensor/actuator cables, boxes and flush-type connectors for the food industry

Drawings

Flush-type connector - SACC-CI-M12FS-8CON-L90 SH SCO - 1437009

Schematic diagram

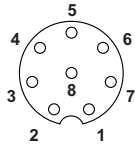

Pin assignment M12 socket, 8-pos., A-coded, view female side

Drilling diagram

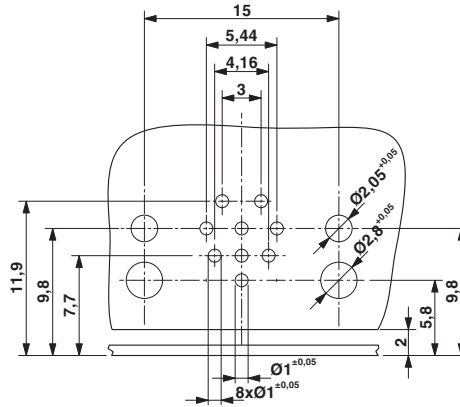

Drilling diagram only valid in connection with the SACC-M12-SCO NUT L90 housing (order no. 1432460)

Dimensioned drawing

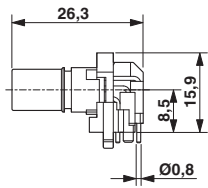

M12 flush-type connector, socket, contact carrier, side view

Dimensioned drawing

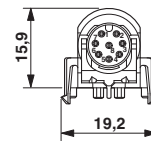

M12 flush-type connector, socket, contact carrier, front view

Dimensioned drawing

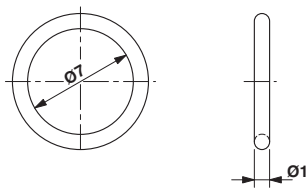

Optionally with O-ring (green) for tight seal when plugged in.
 - the axial mating force of 80 N per connector may not be exceeded when using with assembled O-ring!
 - Avoid radial forces!

Dimensioned drawing

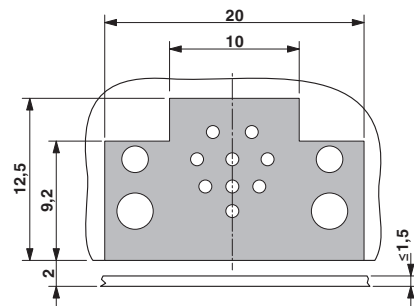

Locked area on the PCB