

**Ordering number C12476\_MIRELLA-50-S**

Family	Mirella	FWHM	13 degrees
Type	Reflector	Efficiency	89 %
LED	BXRA LS	cd/lm	8.600
Color	Metal	Gerber File	Available
Diameter	49.9 mm		
Height	23.9 mm		
Style	Round		
Optic Material	PC		
Holder Material	-		
Fastening	Glue		
Status	Ready		

Not compatible if PCB board fixed down by using screws.

**Ordering number CN12483\_MIRELLA-50-S-DL**

Family	Mirella	FWHM	18 degrees
Type	Pack	Efficiency	83 %
LED	BXRA LS	cd/lm	4.000
Color	Metal	Gerber File	Available
Diameter	49.9 mm		
Height	23.9 mm		
Style	Round		
Optic Material	PC		
Holder Material	-		
Fastening	Glue		
Status	Ready		

Not compatible if PCB board fixed down by using screws.

**Ordering number C12477\_MIRELLA-50-M**

Family	Mirella	FWHM	27 degrees
Type	Reflector	Efficiency	89 %
LED	BXRA LS	cd/lm	2.800
Color	Metal	Gerber File	Available
Diameter	49.9 mm		
Height	23.9 mm		
Style	Round		
Optic Material	PC		
Holder Material	-		
Fastening	Glue		
Status	Ready		

Not compatible if PCB board fixed down by using screws.

**Ordering number C12478\_MIRELLA-50-W**

Family	Mirella	FWHM	35 degrees
Type	Reflector	Efficiency	88 %
LED	BXRA LS	cd/lm	1.900
Color	Metal	Gerber File	Available
Diameter	49.9 mm		
Height	23.9 mm		
Style	Round		
Optic Material	PC		
Holder Material	-		
Fastening	Glue		
Status	Ready		

Not compatible if PCB board fixed down by using screws.

**Ordering number CN12484\_MIRELLA-50-M-DL**

Family	Mirella	FWHM	35 degrees
Type	Pack	Efficiency	83 %
LED	BXRA LS	cd/lm	1.600
Color	Metal	Gerber File	Available
Diameter	49.9 mm		
Height	24 mm		
Style	Round		Not compatible if PCB board fixed down by using screws.
Optic Material	PC		
Holder Material	-		
Fastening	Glue		
Status	Ready		

**Ordering number CN12485\_MIRELLA-50-W-DL**

Family	Mirella	FWHM	43 degrees
Type	Pack	Efficiency	82 %
LED	BXRA LS	cd/lm	1.300
Color	Metal	Gerber File	Available
Diameter	49.9 mm		
Height	23.9 mm		
Style	Round		Not compatible if PCB board fixed down by using screws.
Optic Material	PC		
Holder Material	-		
Fastening	Glue		
Status	Ready		

**NOTE: The typical divergence will be changed by different color, chip size and chip position tolerance. The typical total divergence is the full angle measured where the luminous intensity is half of the peak value.**



## PRODUCT DATASHEET

### Mirella series

last update 3/8/2012



#### GENERAL INFORMATION

- Product series especially designed & optimized for BXRA LS series of LEDs.
- Special care taken to make light distribution as uniform as possible.
- Lens material optical grade PC with high UV and temperature resistance (120 degrees of Celcius / 248 degrees of Fahrenheit). Allows use of high current and temperature conditions.

Please find more information about used materials from below:

[http://ledil.fi/sites/default/files/Documents/Technical/Material/PC%20Makrolon%202400\\_2407\\_2456\\_2458-UL.pdf](http://ledil.fi/sites/default/files/Documents/Technical/Material/PC%20Makrolon%202400_2407_2456_2458-UL.pdf)

- Reflector is made of aluminium coated PC (120 degrees of Celcius / 248 degrees of Fahrenheit) with protective lacquer (110 degrees of Celcius / 230 degrees of Fahrenheit).

- Fastening to PCB with appropriate adhesive. By clicking link below you can find Ledil recommended glue options.

[http://www.ledil.com/datasheets/DataSheet\\_GLUES.pdf](http://www.ledil.com/datasheets/DataSheet_GLUES.pdf)

**NOTE 1: We advise customer to ensure the suitability and sufficiency of the bond in the end product. For example, mechanical stress, vibration and holes on the surface of the circuit board weaken the strength of the glue.**

**NOTE 2: All surfaces where glue is applied must be clean, dry and free from grease and dirt. If cleaning of PCB surfaces is needed, please follow strictly the cleaning instructions of your LED manufacturer -this is important as cleaning shall under no circumstances damage LEDs or other electronics components on the PCB.**

**Further note that optical components shall not be cleaned with any chemicals - only micro fiber cloth may be used to remove fingerprints or other traces from handling.**

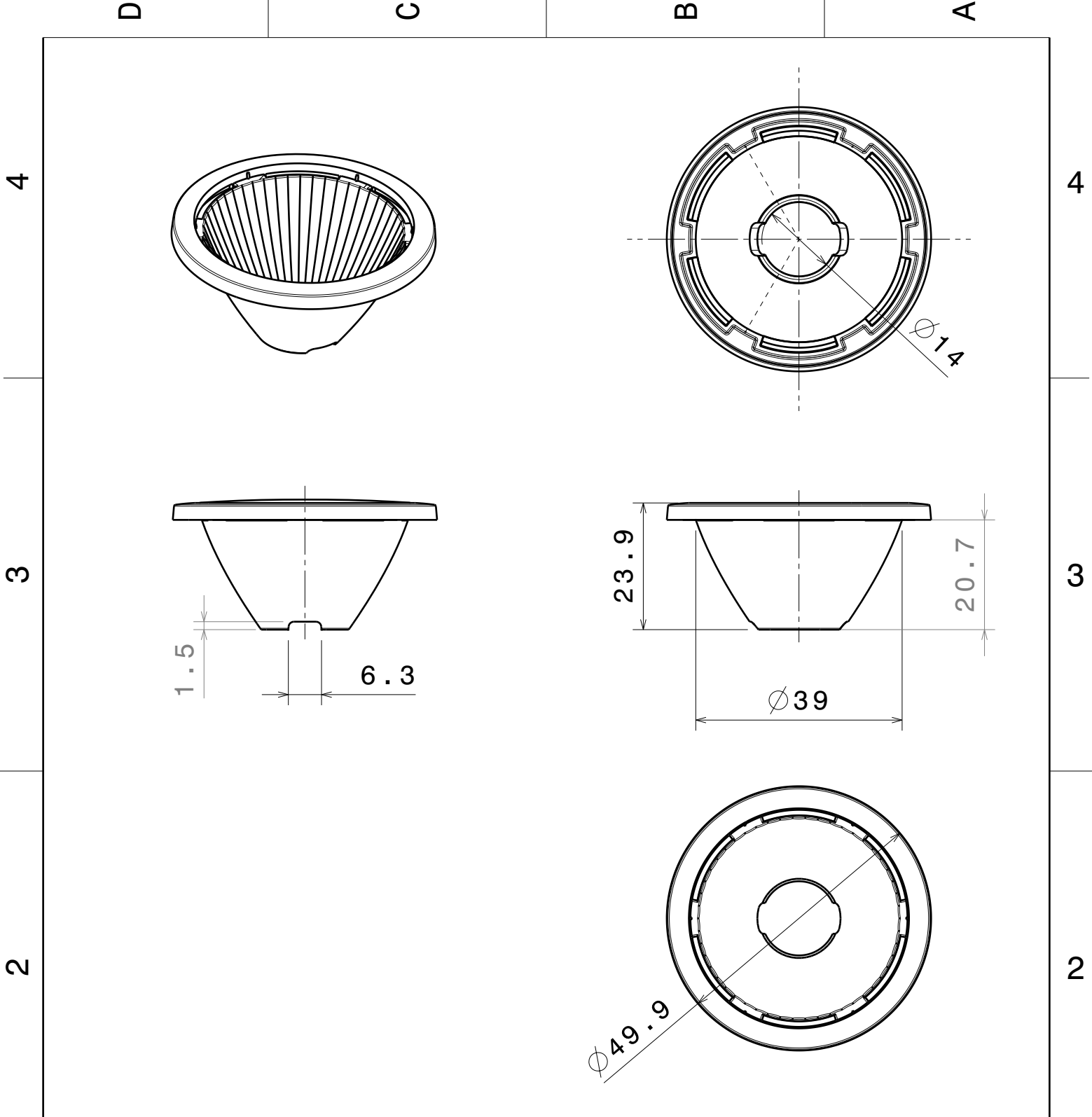

Material: PC, metal plated

This drawing is our property.  
It can't be reproduced  
or communicated without  
our written agreement.



Ledil Oy  
Salorankatu 10  
FIN-24240 SALO  
Finland

DRAWING TITLE

Datasheet Mirella reflector

DRAWN BY pl		DATE 25.11.2011		SIZE A4		DRAWING NUMBER		REV 1	
CHECKED BY		DATE		SCALE 1:1		WEIGHT (g)		SHEET 1/1	
DESIGNED BY pl		DATE 25.11.2011							

D

A

Luminaire: Ledil Oy C12476\_MIRELLA-50-S (Bridgelux LS 170lm @ 250mA) Efficiency=89%  
Lamps: 1 x Bridgelux LS 170lm @ 250mA

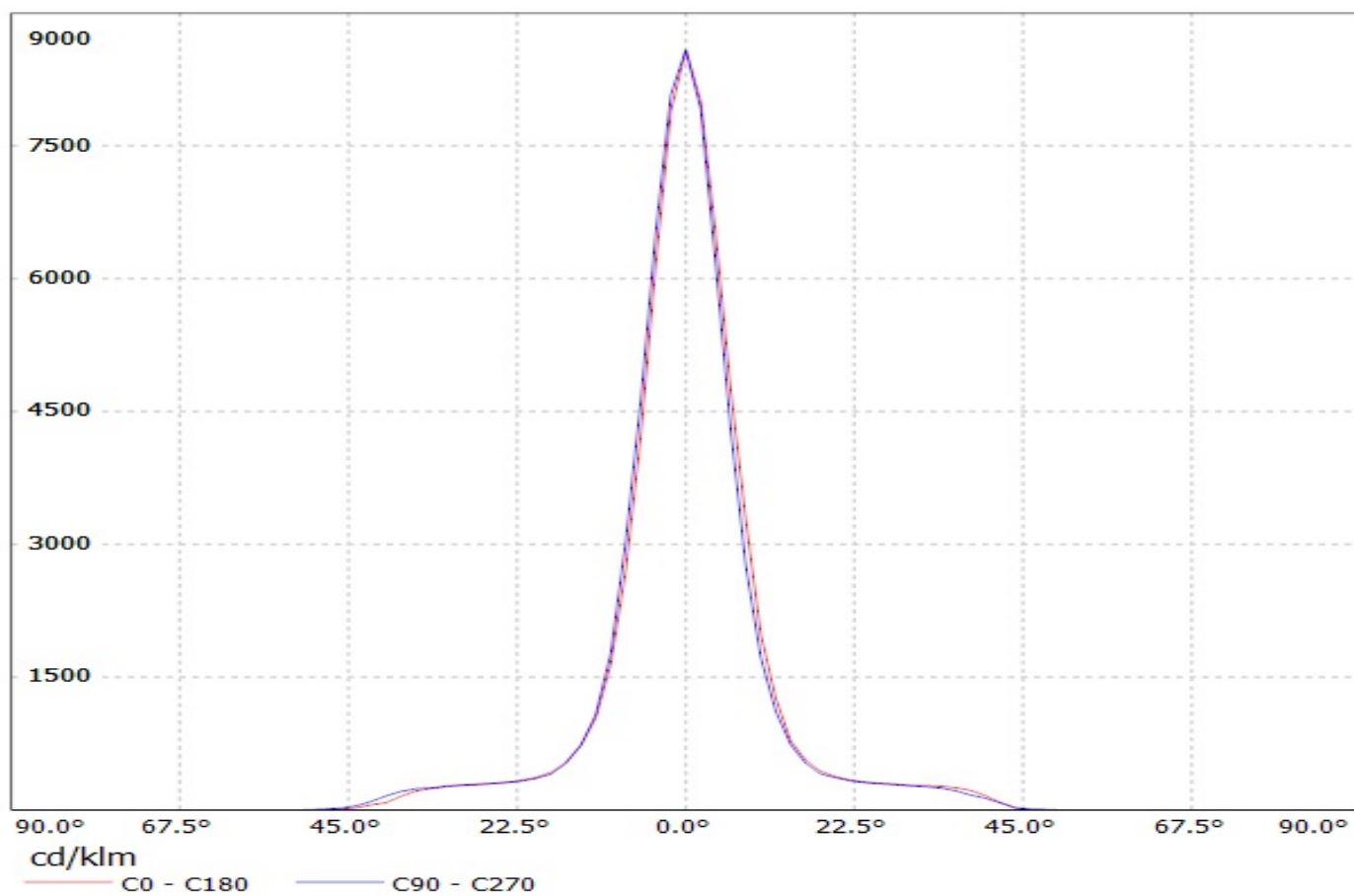

Luminaire: Ledil Oy CN12483\_MIRELLA-50-S-DL (Bridgelux LS 170lm @ 250mA) Efficiency=83%  
Lamps: 1 x Bridgelux LS 170lm @ 250mA

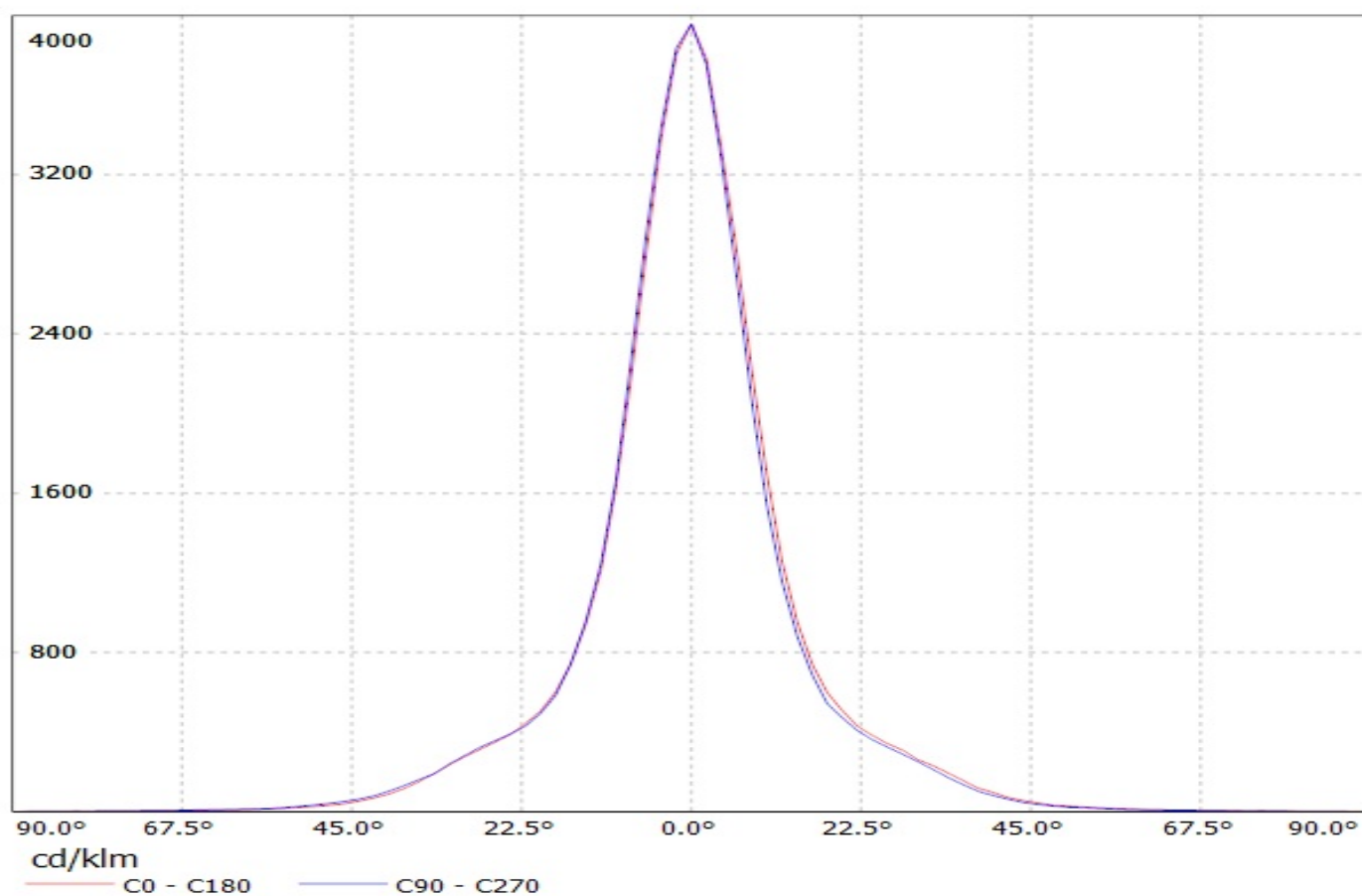

Luminaire: Ledil Oy C12477\_MIRELLA-50-M (Bridgelux LS 170lm @ 250mA) Efficiency=89%  
Lamps: 1 x Bridgelux LS 170lm @ 250mA

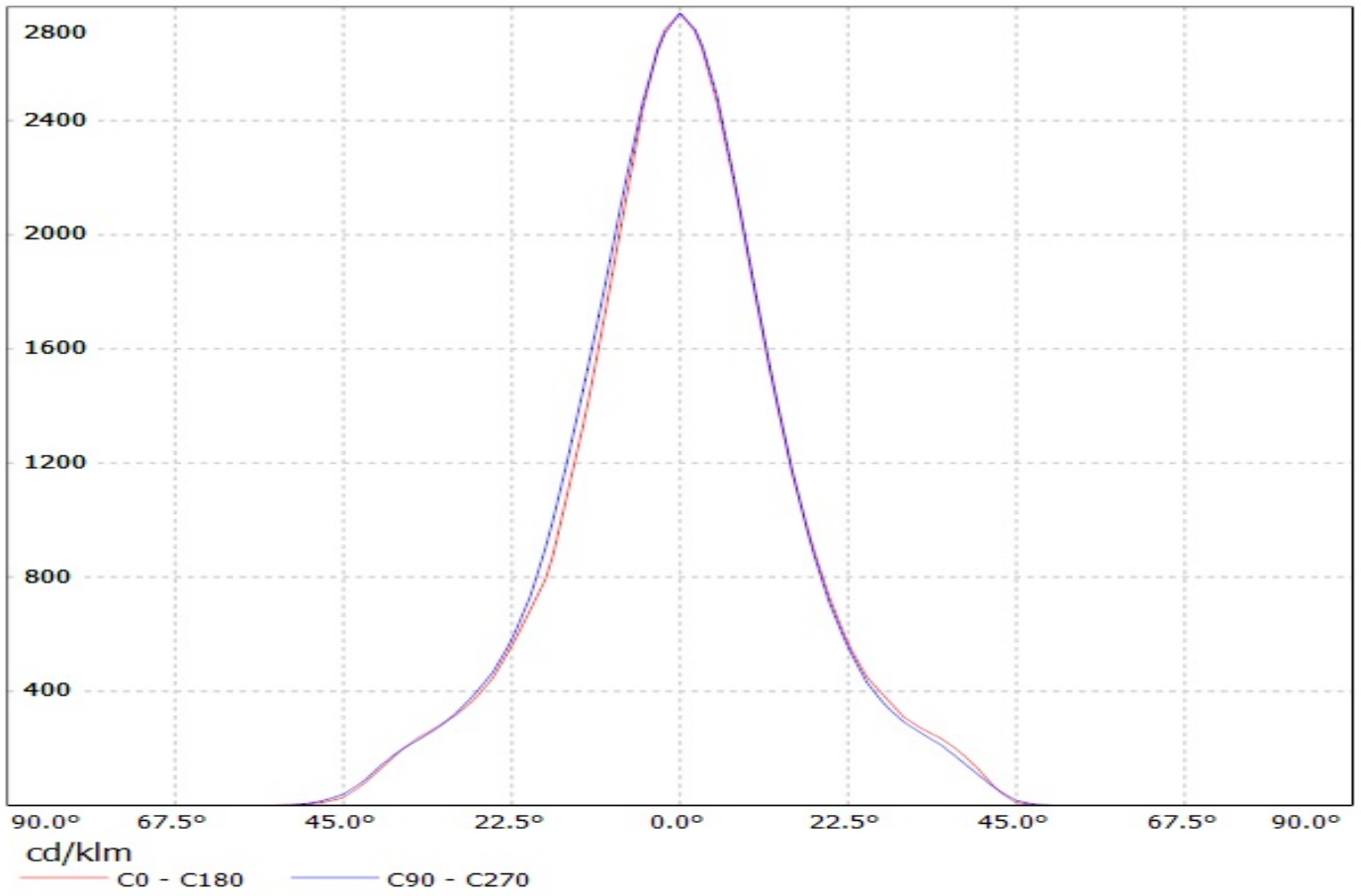

Luminaire: Ledil Oy C12478\_MIRELLA-50-W (Bridgelux LS 170lm @ 250mA) Efficiency=88%  
Lamps: 1 x Bridgelux LS 170lm @ 250mA

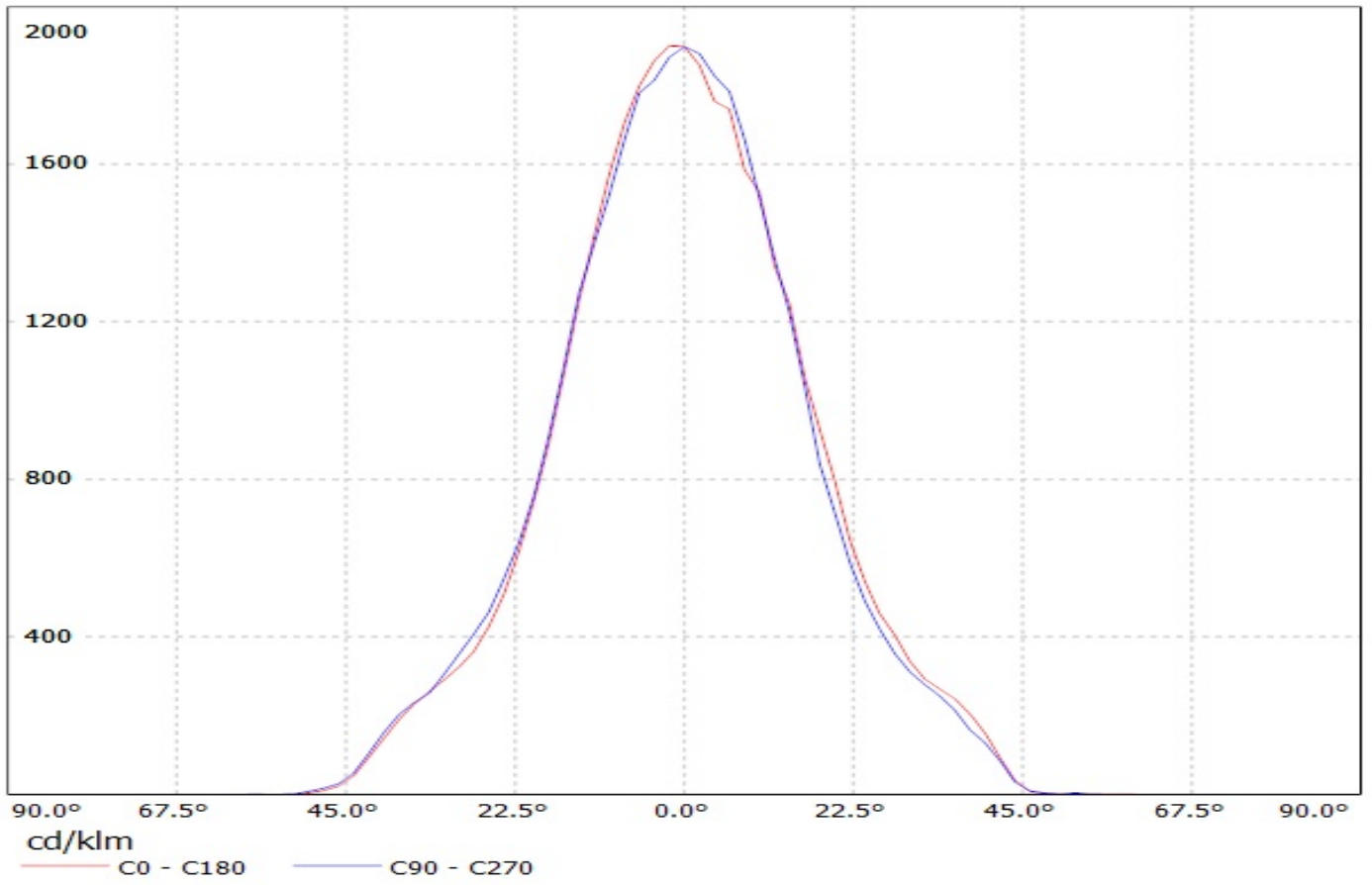

Luminaire: Ledil Oy CN12484\_MIRELLA-50-M-DL (Bridgelux LS 170lm @ 250mA) Efficiency=83%  
Lamps: 1 x Bridgelux LS 170lm @ 250mA

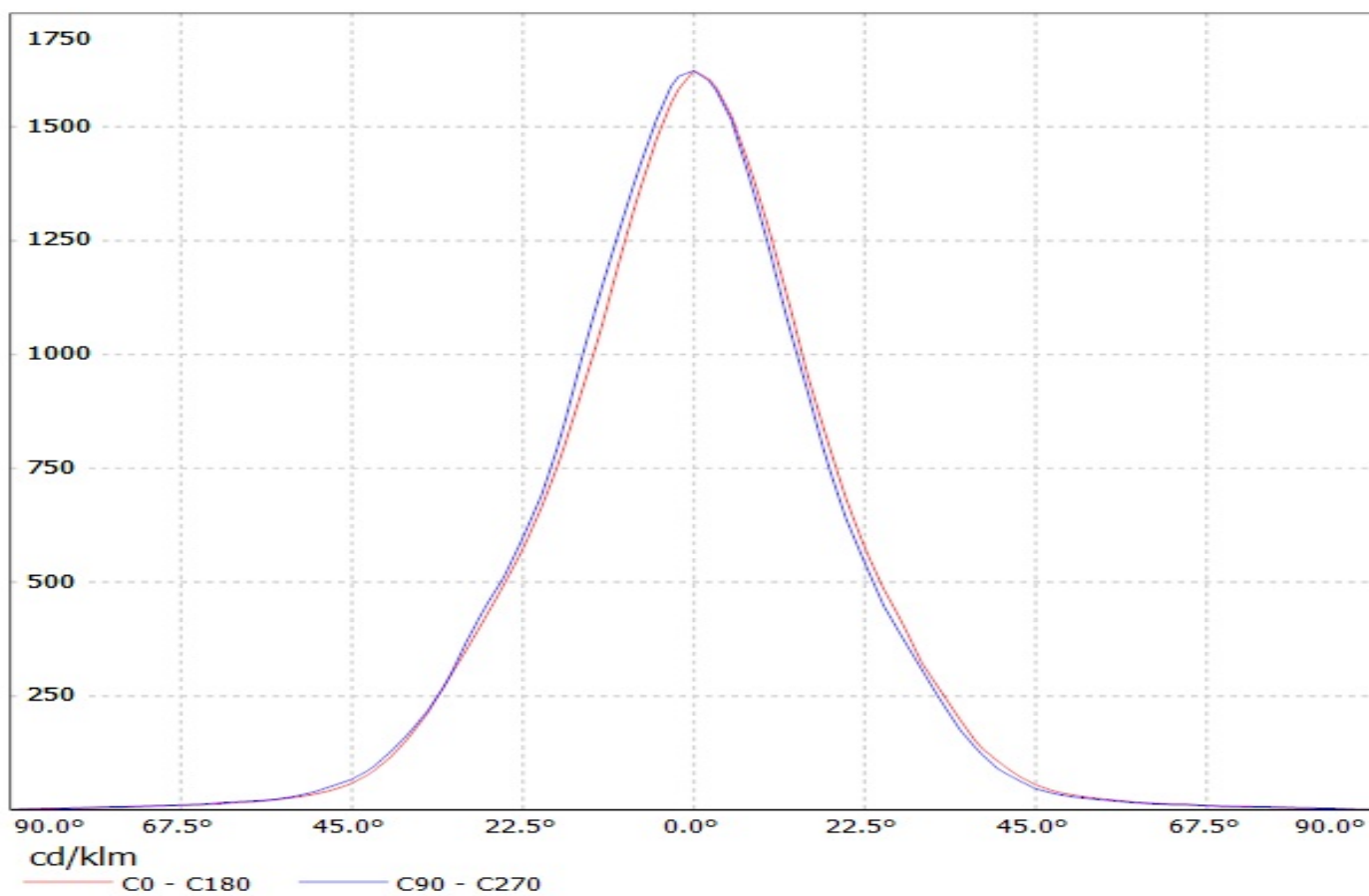

Luminaire: Ledil Oy CN12485\_MIRELLA-50-W-DL (Bridgelux LS 170lm @ 250mA) Efficiency=82%  
Lamps: 1 x Bridgelux LS 170lm @ 250mA

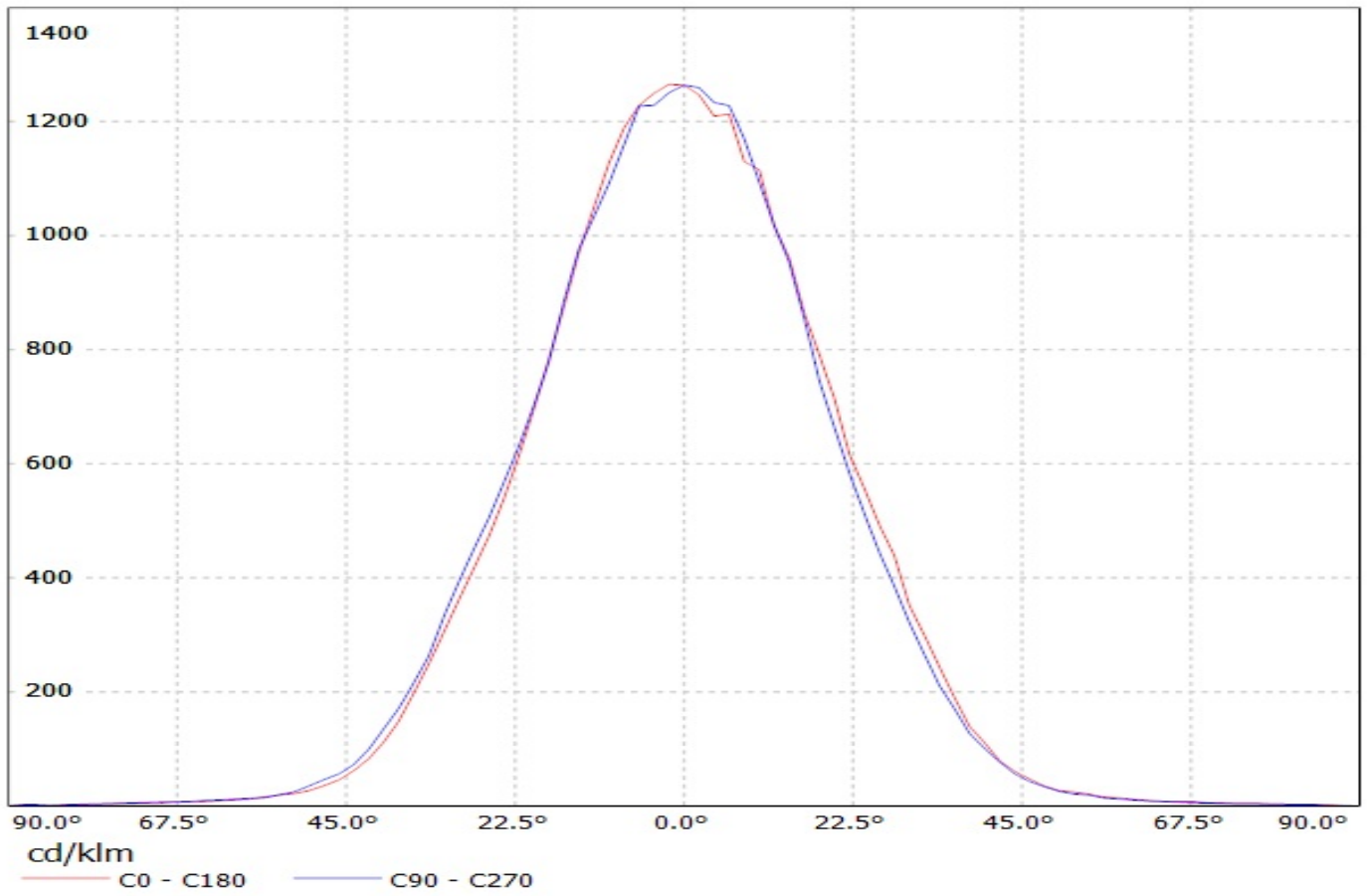

Luminaire: Ledil Oy C12476\_MIRELLA-50-S (Bridgelux LS 170lm @ 250mA) Efficiency=89%  
Lamps: 1 x Bridgelux LS 170lm @ 250mA

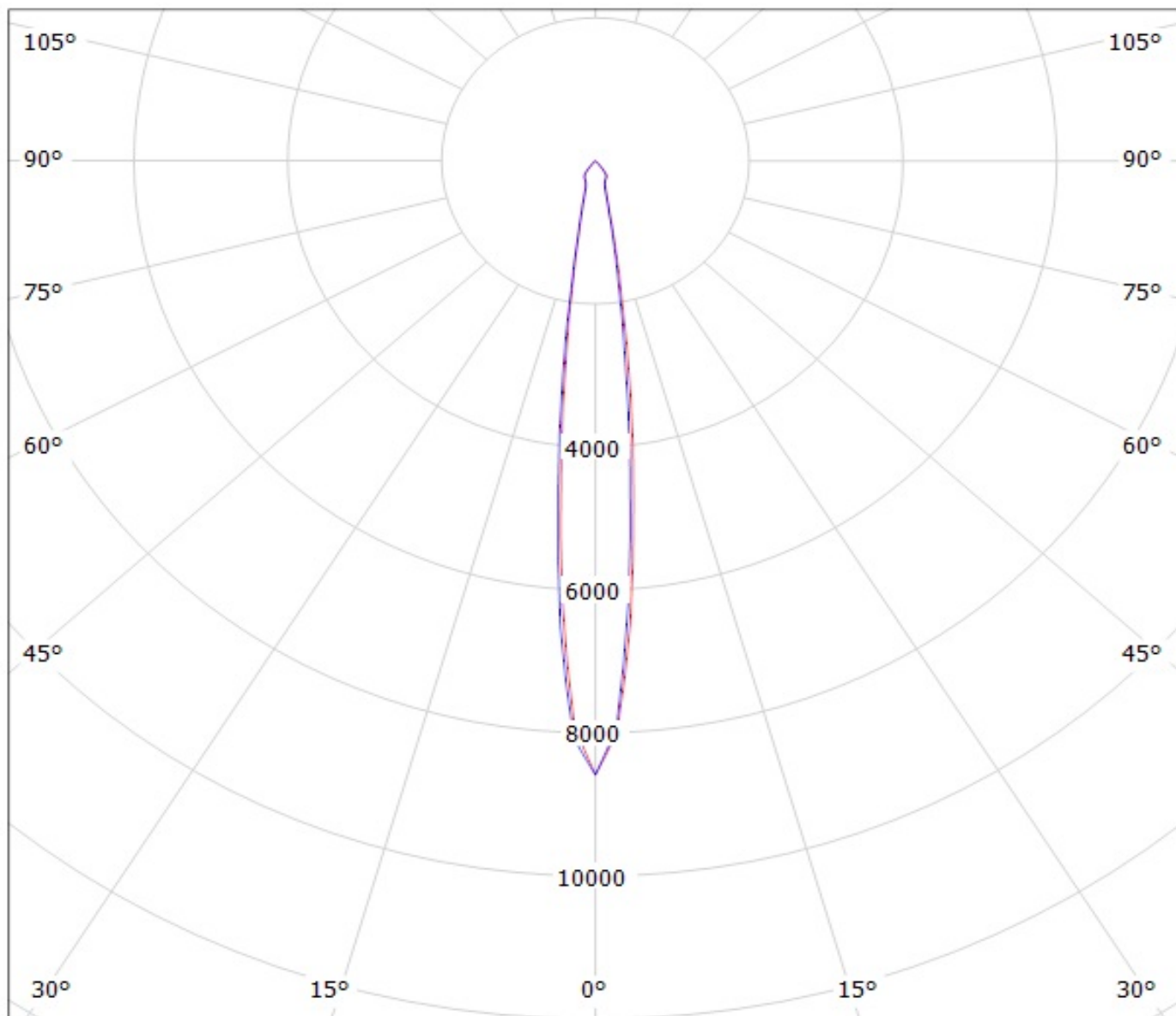

cd/klm

— C0 - C180

— C90 - C270

Luminaire: Ledil Oy CN12483\_MIRELLA-50-S-DL (Bridgelux LS 170lm @ 250mA) Efficiency=83%  
Lamps: 1 x Bridgelux LS 170lm @ 250mA

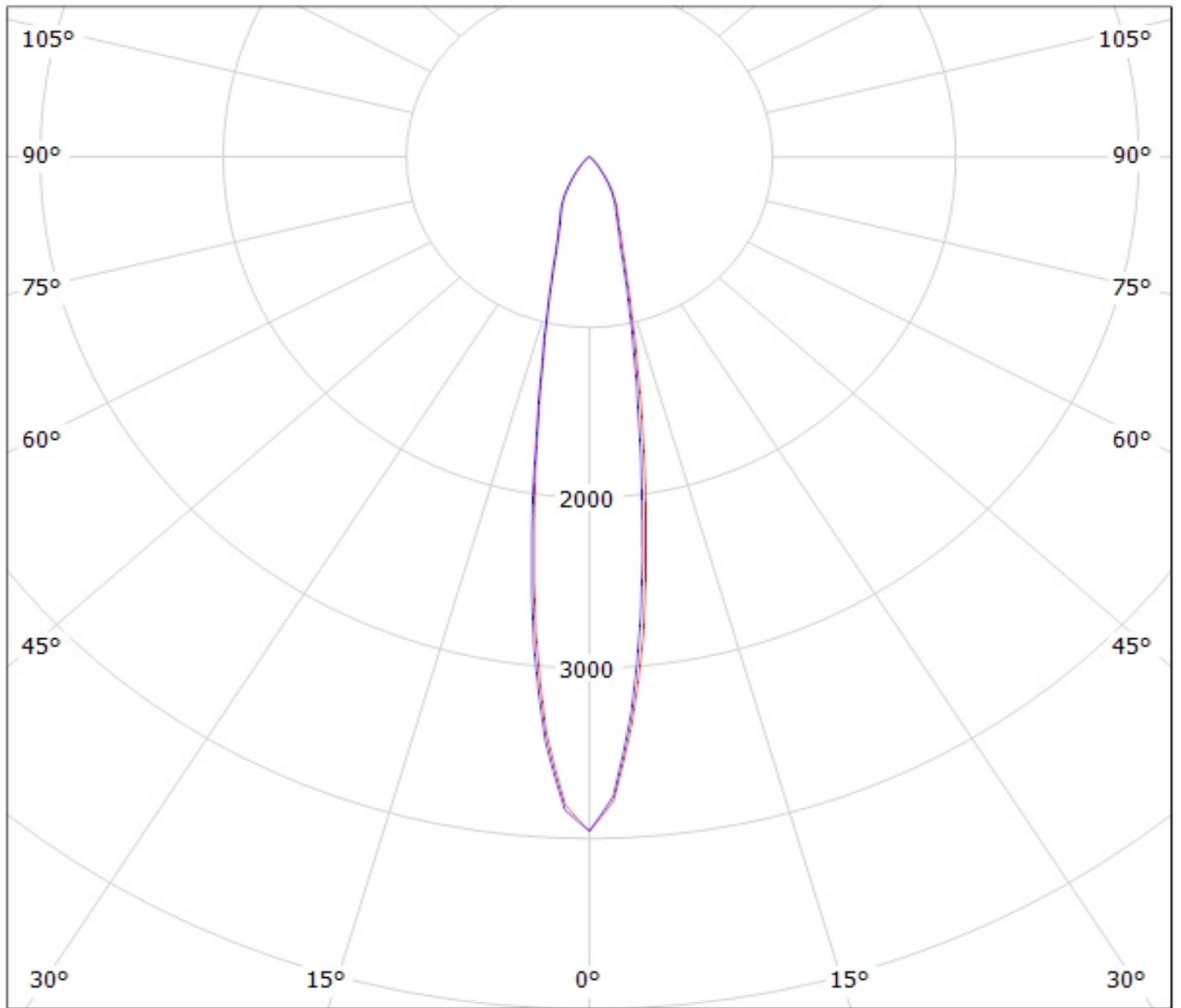

cd/klm

— C0 - C180

— C90 - C270

Luminaire: Ledil Oy C12477\_MIRELLA-50-M (Bridgelux LS 170lm @ 250mA) Efficiency=89%  
Lamps: 1 x Bridgelux LS 170lm @ 250mA

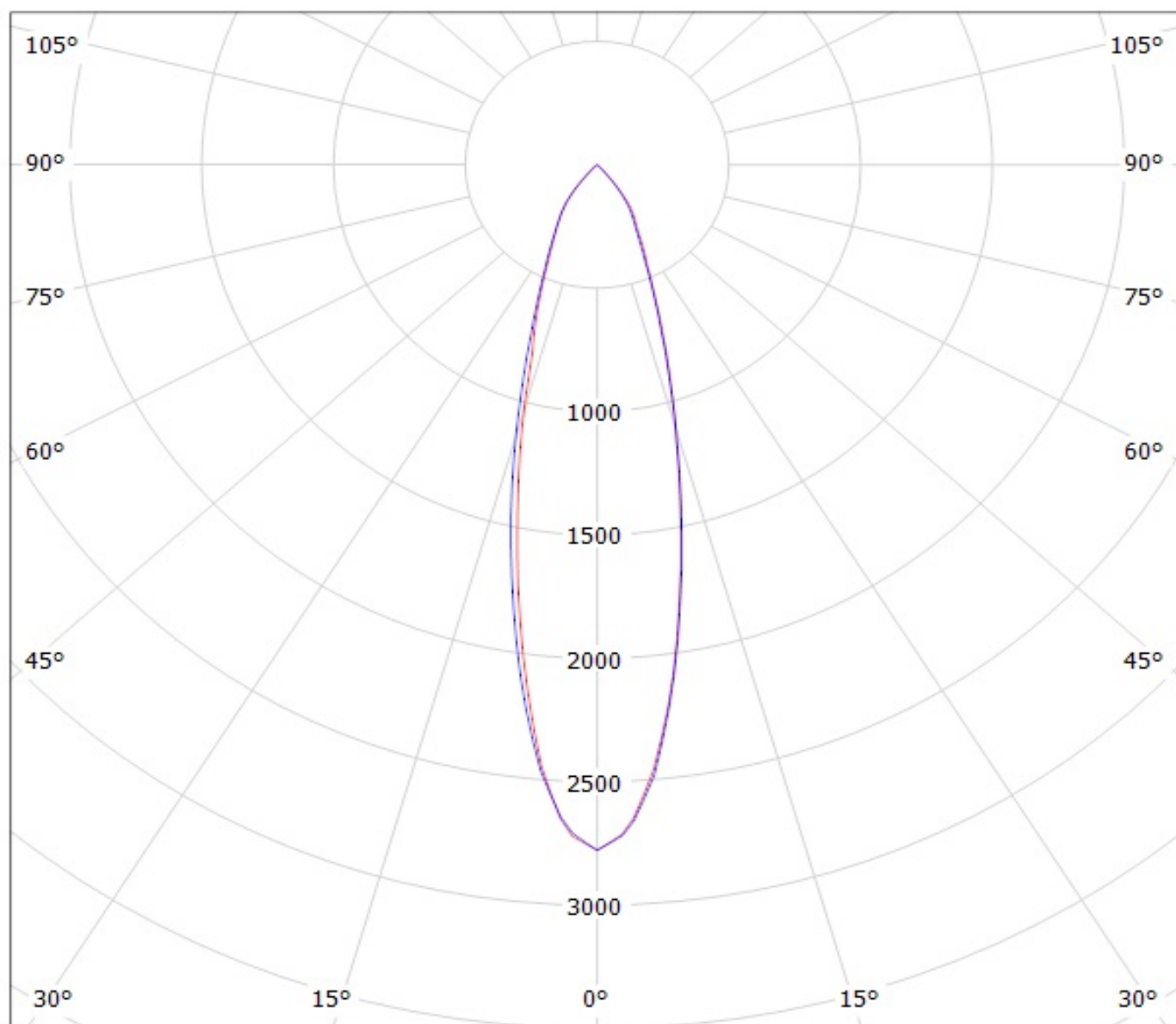

cd/klm

— C0 - C180    — C90 - C270

Luminaire: Ledil Oy C12478\_MIRELLA-50-W (Bridgelux LS 170lm @ 250mA) Efficiency=88%  
Lamps: 1 x Bridgelux LS 170lm @ 250mA

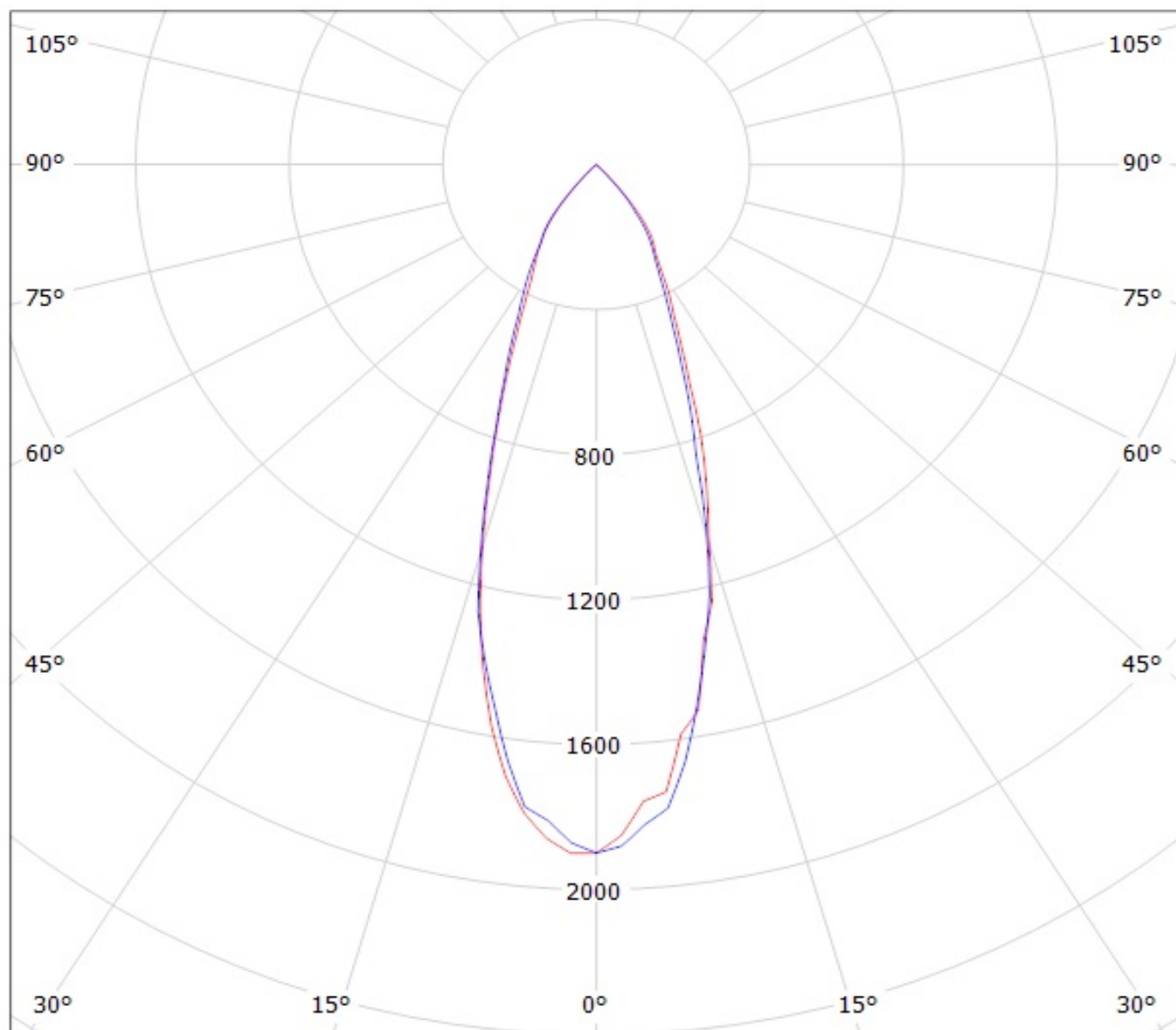

cd/klm

— C0 - C180    — C90 - C270

Luminaire: Ledil Oy CN12484\_MIRELLA-50-M-DL (Bridgelux LS 170lm @ 250mA) Efficiency=83%  
Lamps: 1 x Bridgelux LS 170lm @ 250mA

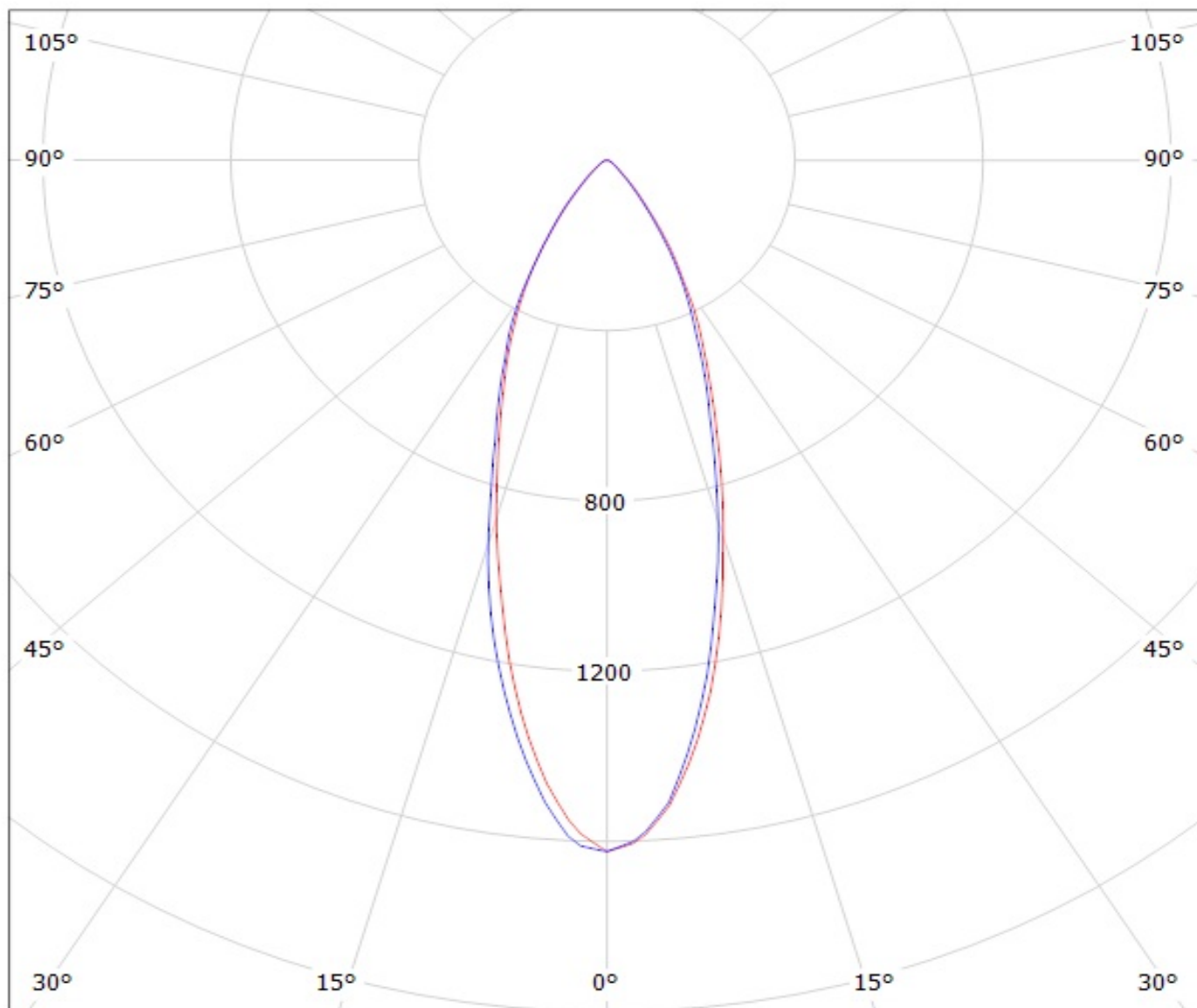

cd/klm

— C0 - C180

— C90 - C270

Luminaire: Ledil Oy CN12485\_MIRELLA-50-W-DL (Bridgelux LS 170lm @ 250mA) Efficiency=82%  
Lamps: 1 x Bridgelux LS 170lm @ 250mA

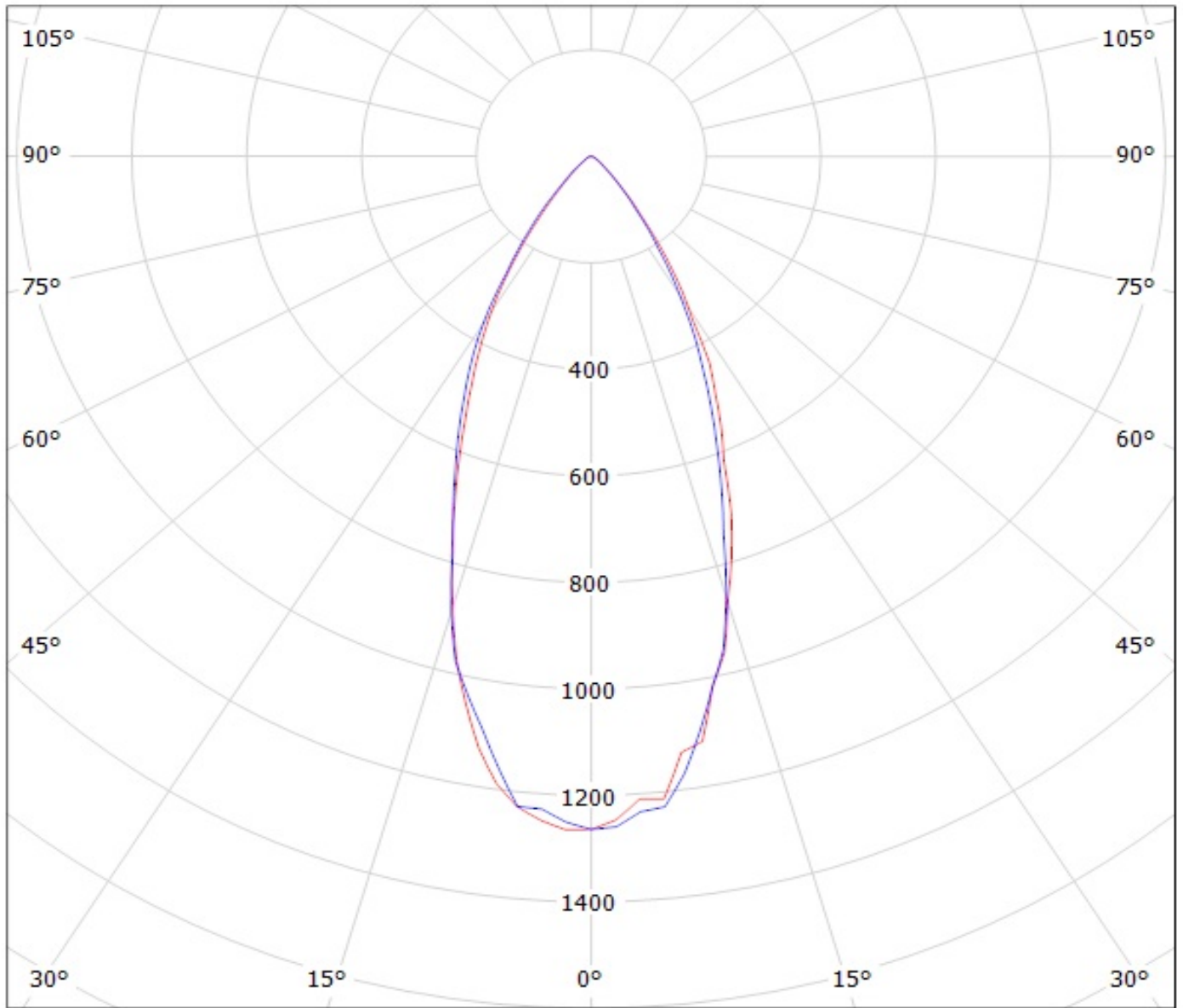

cd/klm

— C0 - C180    — C90 - C270