

OSLON® Square 4+ PowerStar Colours

ILH-0004-xxxx-SC211-xx Series

Product Overview

At the heart of each PowerStar are 4 OSLON® SSL Square ThinGan (UX:3) LEDs. OSLON® SSL can be driven up to 1000 mA while OSRAM's latest power chip technology remains efficient even at the highest drive currents. A low thermal resistance of 7 K/W ensures cool running and a highly efficient product. PowerStars are compact, powerful LED light sources built on aluminium substrates for optimal thermal management. Available with 200mm wires as standard.

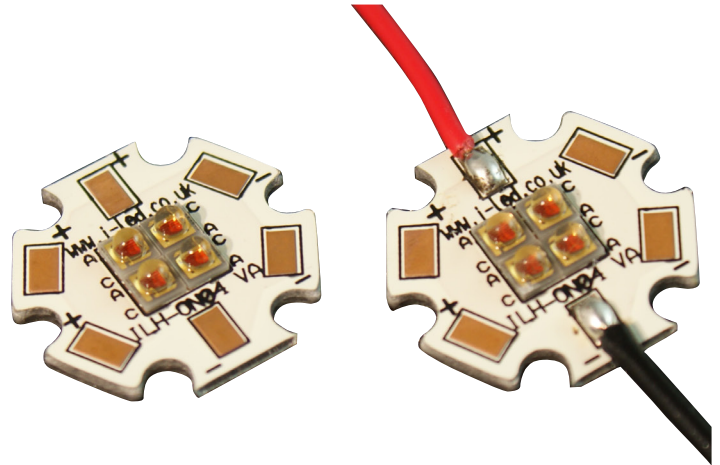

Applications

- General Lighting
- Decorative Lighting
- Task Lighting
- Spot Lighting
- Downlighters
- Retail and Entertainment Lighting

Technical Features

- OSLON® Square 4+ PowerStars contain OSLON® SSL Square LEDs with integral 120 degree silicon resin Lenses
- Up to 100,000 Hour lifetime to 70% of original brightness
- Mounting holes using M3 screws allows easy installation
- Size (L x W x H) : 20mm x 20mm x 3.85mm
- Available with 200mm connecting wires
- Secondary Lens can be fitted – check options in suitable Lens and Reflector section
- Suitable Heat Sinks available – check options in Heat Sink section
- Matching Power Supply available - check options in Power Supply section
- PowerStars can be linked together to produce longer chains
- Current range 100 to 1,000mA.

*This datasheet should be read in conjunction with the relevant OSRAM Opto Semiconductors data on the LED used

Important Information and Precautions

- The PowerStar’s LED, when powered up, is very bright. Thus it is advised that you do not look directly at it. Turn the PowerStar away from you and do not shine into the eyes of others.
- PowerStars will overheat in operation if not attached to a suitable Heat Sink. Over heating can cause failure or irreparable damage.
- Do not operate PowerStars with a Power Supply with unlimited current. Connection to constant voltage Power Supplies that are not current limited may cause the PowerStar to consume current above the specified maximum and cause failure or irreparable damage.
- PowerStars, when operated, can reach high temperatures thus there is risk of injury if they are touched.
- DO NOT HOT PLUG ON LED SIDE OF POWER SUPPLY.

Product Options

ILS PART NUMBER	Colour	Dominant Wavelength*	TypicalWattage §		Forward Voltage	Flux † at 700mA	Radiance Angle	Relevant OSRAM LED Data
			at 350mA	at 700mA				
ILH-0004-DEBL-SC211-WIR200.	Deep Blue	455nm	4.34 watts	8.68 watts	10.80 to 14.0 volts	<5600 mW	120° (± 60°)	LDCQAR

* Due to the special conditions of the manufacturing processes of LEDs, the typical data of technical parameters can only reflect statistical figures and do not necessarily correspond to the actual parameters of each single product which could differ from the typical data.

§ Tolerance +/- 10%

† Measured with 20mS 700mA pulse at 25 °c

Minimum and Maximum Ratings

ILS PART NUMBER	Operating Temperature at Tc-Point [°C]*	Storage Temperature [°C]*	Forward Current per chip [mA]*	Reverse Voltage [Vdc] *
ILH-0004-DEBL-SC211-WIR200.	70 °C max	- 40 to 110 °C	1,000mA max	not designed for reverse voltage

* Exceeding maximum ratings for operating and storage temperature will reduce expected life time or destroy the LED module.

Exceeding maximum ratings for operating voltage will cause hazardous overload and will likely destroy the LED module.

The temperature of the LED module must be measured at the Tc-Point according to EN60598-1 in a thermally constant status with a temperature sensor or a temperature sensitive label.

Radiation of single LED

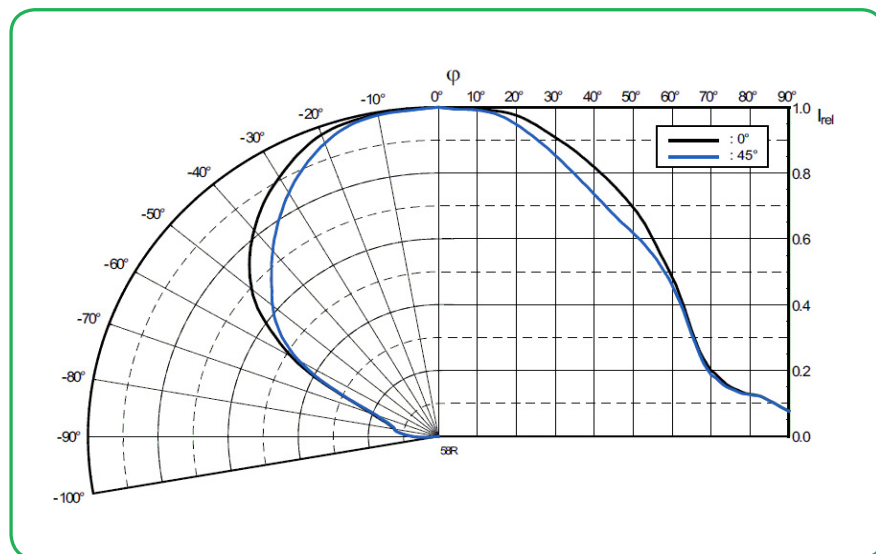

Technical Drawing with cables (mm)

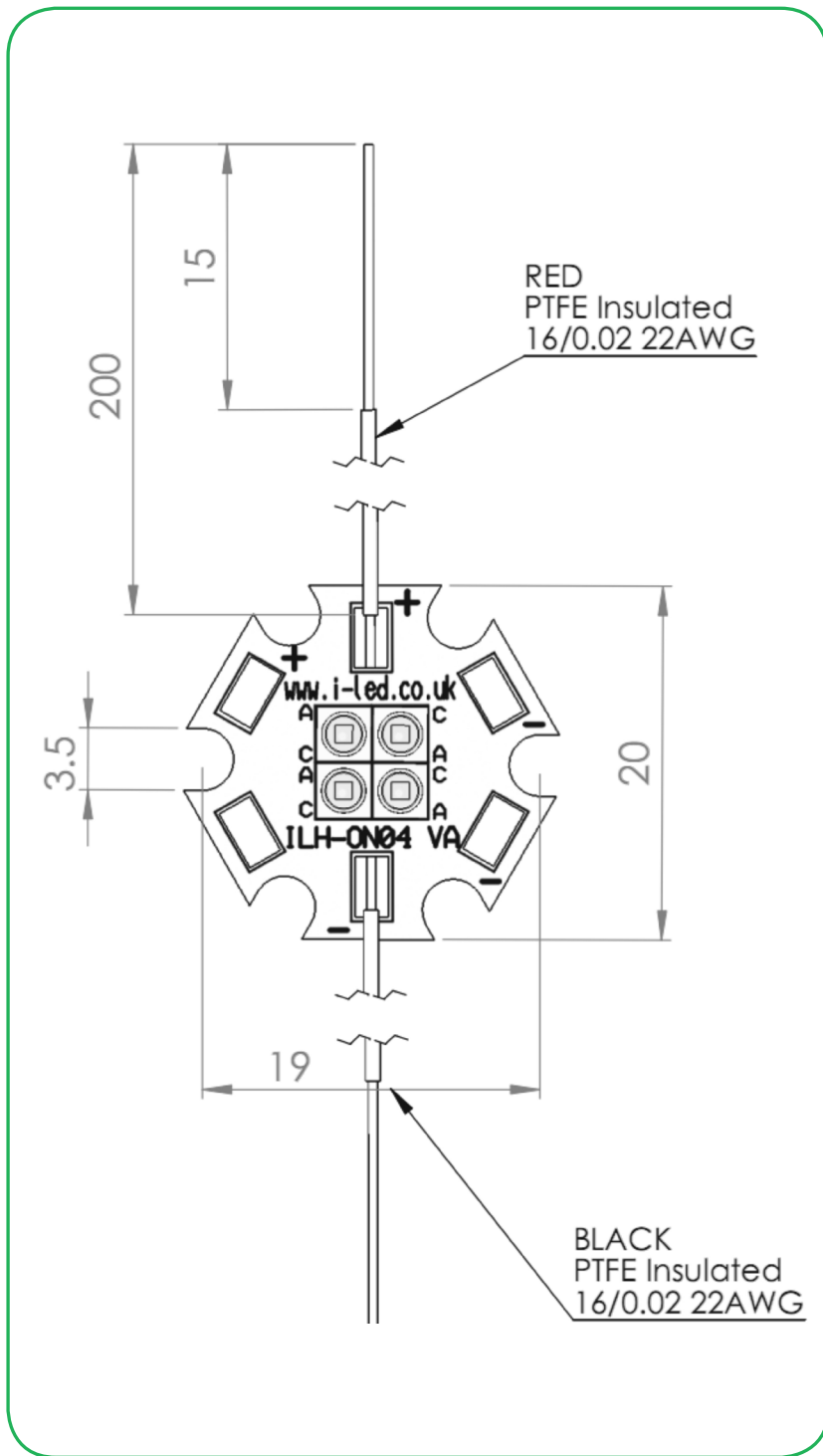

3D drawing files are available on request from ILS. Please call or email

OSLON® Square 4+ PowerStar Lens and Reflector Options

LEDiL precision-engineered Lenses and Reflectors allow for rapid deployment of all types of light fixtures, including street lights, wall-wash, high-bay, sconces, emergency beacons, parking garage/low-bay, MR and AR downlights, and dock lights. Precision-engineered for maximum efficiency and durability, LEDiL Lenses and Reflectors are released alongside the latest product releases from our LED suppliers. You select the best LED for the application; choose LEDiL and you're selecting the best optical solution as well.



Lenses

Currently there are no Lens options for the OSLON® 4+ range of products.

Reflectors

	OSLON+ 80	OSLON+ 150	OSLON SQUARE	
ILS Part Number	Beam Angle (FWHM)	Beam Angle (FWHM)	Beam Angle (FWHM)	Mounting Type
LISA2-XX	76	83	82	Glue,Pin
MIRRELLA-XX	Measurement data available shortly	Measurement data available shortly	14,32,50	Pin and Glue
BOOMERANG	Measurement data available shortly	Measurement data available shortly	Measurement data available shortly	Glue
RITA	Measurement data available shortly	Measurement data available shortly	Asymmetric	

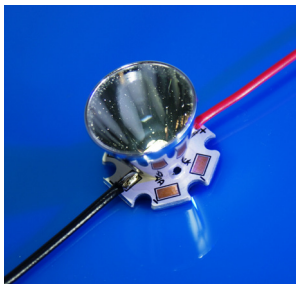

with Lisa Reflector

OSLON® Square 4+ PowerStar Heat Sink Options

ILS has recently introduced a series of Aluminium Alloy Heat Sinks to be used with our standard range of PowerStars and PowerClusters. These Heat Sinks are supplied with fixing screws for the light engine and for fixing to a base plate. They also come with Thermal Interface Material (TIM) attached to the top surface. Available in Black, Red, Silver and Blue colour variants. More versions will be introduced over the coming months and we are also happy to manufacture custom Heat Sinks to your request.

	Operates under the recommended ILS junction temperature
	Operates under the recommended LED maximum junction temperature
	Not suitable for use
N/A	Heat Sink not designed for use with this product



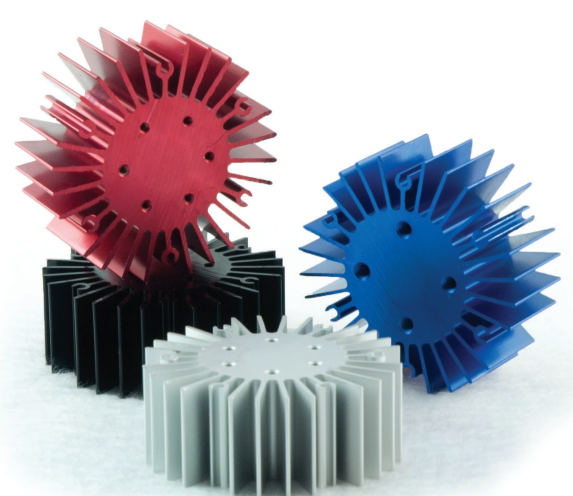
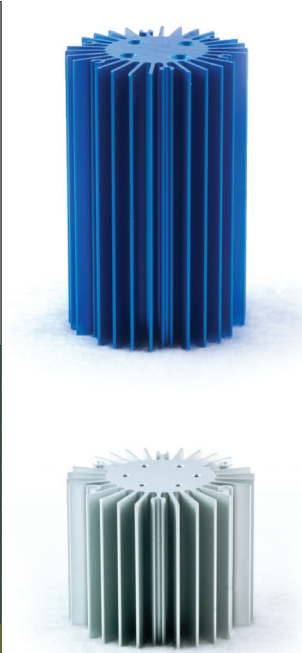





ILS Product		No Heat Sink, in free air	ILA-HEATSINK-STAR-50X20MM.	ILA-HEATSINK-STAR-50X40MM.	ILA-HEATSINK-STAR-50X60MM.	ILA-HEATSINK-STAR-50X80MM.	ILA-HEATSINK-CLUSTER-70X70X55MM.	ILA-HEATSINK-CLUSTER-78X46X25MM.
Oslon 1+ PowerStars	350mA							
	700mA							
	1000mA							
Oslon 4+ PowerStars	350mA							
	700mA							
	1000mA							
Oslon 9+ PowerStars	350mA							
	700mA							
	1000mA							
Oslon 16+ PowerClusters	350mA							
	700mA							
	1000mA							



OSLON®Square 4+ PowerStar Power Supply Options

ILS has a comprehensive range of standard Power Supplies. The table below shows the total number of ILS products each Power Supply can drive.

Additional Power Supplies are being introduced so please call us or check our website for the latest offering.

ILS Driver Part No.	Rating	Current	OSLON®Square 4+ PowerStar	
IZC035-008F-5065C-SA	8W	350mA	1	
IZC035-018T-9500A-SA	18W	350mA dim	1-3	
IZC050-018T-9500A-SA	18W	500mA dim	1-2	
IZC070-018T-9500A-SA	18W	700mA dim	1	
IZC035-017F-0067A-SA	17W	350mA	1-3	
IZC070-035F-0067C-SA	35W	700mA	1-4	
IZC045-040A-9266C-SA	40W	450mA dim	3-5	
IZC070-050A-9267C-SA	50W	700mA dim	2-5	
IZC070-075A-9267C-SA	75W	700mA dim	5-7	
OT 9/200-240/350	8.5W	350mA	1	
OT 9/200-240/350 DIM	8.5W	350mA dim	1	
OT 18/200-240/700 DIM	18W	700mA dim	1	
OT 35/200-240/700	35W	700mA	1-3	
OT 42/220-240/500 E	42W	500mA	3-5	
OT 42/220-240/350 E	42W	350mA	3-8	

Thermal Interface Material Options

ILS have produced a range of High-performance, cost effective Thermal Interface Materials to match perfectly their standard products.

Our product fills the air pockets between the two surfaces, forming a continuous layer to conduct heat away from the LED to the Heat Sink.

ILS offer our TIM in three options – double sided adhesive, single sided adhesive and non adhesive.

Product	Non Adhesive	Single Sided Adhesive	Double Sided Adhesive
Star	ILA-TIM-STAR-0A	ILA-TIM-STAR-1A	ILA-TIM-STAR-2A.
25x25mm Cluster	ILA-TIM-CLUSTER-25x25-0A	ILA-TIM-CLUSTER-25x25-1A	ILA-TIM-CLUSTER-25x25-2A.
30x30mm Cluster	ILA-TIM-CLUSTER-30x30-0A	ILA-TIM-CLUSTER-30x30-1A	ILA-TIM-CLUSTER-30x30-2A.
300x20mm Strip	ILA-TIM-STRIP-300x20-0A	ILA-TIM-STRIP300x20-1A	ILA-TIM-STRIP-300x20-2A.
25x15mm Strip	ILA-TIM-STRIP-25x15-0A	ILA-TIM-STRIP-25x15-1A	ILA-TIM-STRIP-25x15-2A.
58x58mm Square	ILA-TIM-SQUARE-58X58-0A	ILA-TIM-SQUARE-58X58-1A	ILA-TIM-SQUARE-58X58-2A.

Other sizes are available, including customised parts

Assembly Information

- The mounting of the OSLO[®] Square 4+ PowerStar has to be on a metal Heat Sink.
- In order to optimise the thermal management, the metal surface needs to be clean (dirt and oil free) and planar for the best contact with the LED module. A thermal grease or heat transfer material is highly recommended.

Safety Information

- The LED module itself and all its components must not be mechanically stressed.
- Assembly must not damage or destroy conducting paths on the circuit board.
- The mounting of the module is carried out by attaching it at the mounting holes. Metal mounting screws must be insulated with synthetic washers to prevent circuit board damage and possible short circuiting.
- To avoid mechanical damage to the connecting cables, the boards should be attached securely to the intended substrate. Heavy vibration should be avoided.
- Observe correct polarity!
- Depending on the product, incorrect polarity will lead to emission of red or no light. The module can be destroyed!
- Pay attention to standard ESD precautions when installing the OSLO[®] Square 4+ PowerStar.
- The OSLO[®] Square 4+ PowerStars, as manufactured, have no conformal coating and therefore offer no inherent protection against corrosion.
- Damage by corrosion will not be accepted as a materials defect claim. It is the user's responsibility to provide suitable protection against corrosive agents such as moisture and condensation and other harmful elements.
- For outdoor usage, a housing is definitely required to protect the board against environmental influences. The design of the housing must correspond to the IP standards in the application. It is also the responsibility of the user to ensure any housings or modifications keep the T_c junction temperature to within stated ranges.
- To also ease the luminaire/installation approval, electronic control gear for LED or LED modules should carry the CE mark and be ENEC certified. In Europe the declarations of conformity must include the following standards: CE: EC 61374-2-13, EN 55015, IEC 61547 and IEC 61000-3-2 - ENEC: 61374-2-13 and IEC/EN 62384.

- Due to the cancellation of the LED from IEC 60825, the evaluation of eye safety occurs according to the standard IEC 62471:2006 (“photobiological safety of lamps and lamp systems”).
Within the risk grouping system of this CIE standard, the LEDs specified in this datasheet fall into the “moderate risk” group for deep blue and “exempt” group for true green (relating to devices in the visible spectrum with an exposure time of 0.25s for deep blue or 10,000s for green). Under real circumstances (for exposure time, eye pupils, observation distance), it is assumed that no endangerment to the eye exist from these devices.
As a matter of principle, however it should be mentioned that intense light sources have a high secondary exposure potential due to their blinding effect. As is also true when viewing other bright light sources (e.g. headlights). temporary reduction in visual acuity and afterimages can occur, leading to irritation, annoyance, visual impairment and even accidents, depending on the situation.

For further information please contact ILS

The values contained in this data sheet can change due to technical innovations. Any such changes will be made without separate notification.