

PLEASE CHECK WWW.MOLEX.COM FOR LATEST PART INFORMATION

Part Number: [19-09-1069](#)
Status: **Active**
Overview: Standard .093" Pin and Socket Connectors
Description: 2.36mm Diameter Standard .093" Pin and Socket Receptacle Housing with Positive Latch, UL 94V-2, 6 Circuits

Documents:

[3D Model](#) [RoHS Certificate of Compliance \(PDF\)](#)
[Drawing \(PDF\)](#)

Agency Certification

CSA LR19980
 UL E29179

General

Product Family Crimp Housings
 Series [3191](#)
 Application Power, Wire-to-Board, Wire-to-Wire
 Comments Polarized to Mating Part, without Mounting Ears
 Overview [Standard .093" Pin and Socket Connectors](#)
 Product Name Standard .093"
 UPC 800753594517

Physical

Breakaway No
 Circuits (maximum) 6
 Circuits Detail 2x3
 Color - Resin Natural
 Flammability 94V-2
 Gender Receptacle
 Glow-Wire Compliant No
 Keying to Mating Part None
 Lock to Mating Part Yes
 Material - Resin Nylon
 Net Weight 4.893/g
 Number of Rows 2
 Packaging Type Bag
 Panel Mount No
 Pitch - Mating Interface 6.70mm
 Polarized to Mating Part Yes
 Stackable No
 Temperature Range - Operating -40°C to +105°C

Electrical

Current - Maximum per Contact 9A

Material Info

Old Part Number 3191-6R1

Reference - Drawing Numbers

Sales Drawing SD-3191-6*

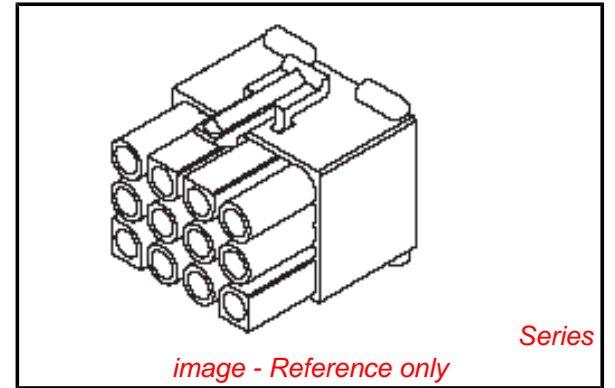

EU RoHS

ELV and RoHS Compliant
REACH SVHC Contains SVHC: No
Low-Halogen Status Low-Halogen

China RoHS



Need more information on product environmental compliance?

Email productcompliance@molex.com
 For a multiple part number RoHS Certificate of Compliance, [click here](#)

Please visit the [Contact Us](#) section for any non-product compliance questions.

Search Parts in this Series

[3191Series](#)

Mates With

[19-09-2066](#) , [19-09-2067](#) , [19-09-2068](#) ,
[19-09-2069](#) , [5219](#)

Use With

[1189](#) Crimp Terminals, [1190](#) Crimp Terminals, [1380](#) Male Crimp Terminals, [1381](#) Female Crimp Terminals, [1433](#) Crimp Terminals, [1434](#) Male Crimp Terminals, [2605](#) , [2606](#) , [1973](#) , [2151](#) , [2273](#) , [2870](#) , [2871](#) , [4272](#)