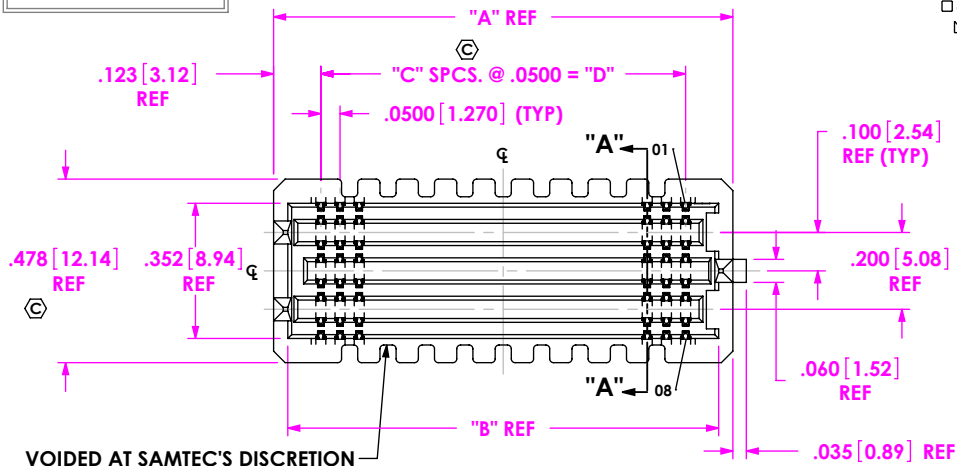


DO NOT  
SCALE FROM  
THIS PRINT



VOIDED AT SAMTEC'S DISCRETION

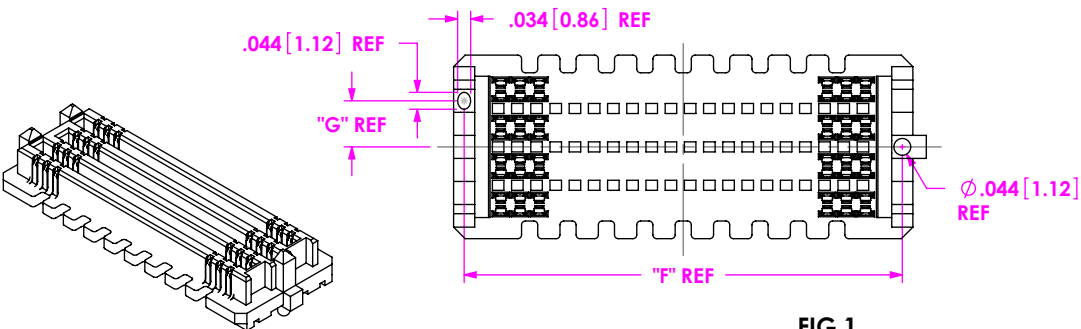
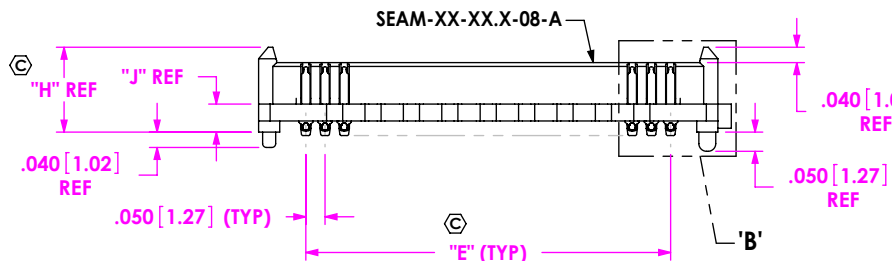


FIG 1  
-08: 8 ROW  
(SEAM-30-02.0-XX-08-1-A-XX-K-TR SHOWN)  
(SOME CENTER FEATURES REMOVED FOR CLARITY)

NOTES:

- ⊙ REPRESENTS A CRITICAL DIMENSION.
- MINIMUM PUSHOUT FORCE: 0.50 LBS.
- NOTE DELETED.
- 5 ROW SOLDER TAILS ARE NOT SYMMETRICAL WITH BODY WIDTH (.378[9.60] SEE FIG. 7, SHEET 5).
- WHEN APPLICABLE, DIMENSION C8 MUST BE MEASURED USING INSPECTION FIXTURE AT-1817-836-1 FOR 4 ROW OR AT-1817-836-2 FOR 6, 8 & 10 ROW, USE CO-AU-WI-2003-M FOR PROCESS.
- WITHOUT -A, AVAILABLE FOR EXISTING CUSTOMERS ONLY AS OF REVISION AD.
- K DOT WILL BE SUPPLIED WHETHER OR NOT -TR IS SPECIFIED.
- TAPE & REEL WILL BE SUPPLIED WHETHER OR NOT -TR IS SPECIFIED.
- FOR QUANTITIES UP TO 49 PIECES, NO LEADER, TRAILER, OR REEL WILL BE SUPPLIED.
- FOR QUANTITIES 50 - 124, NO LEADER OR TRAILER WILL BE SUPPLIED.
- ATTACH LABEL "SEAX-0001" TO EACH TAPE & REEL PACKAGE.
- SOLDER CHARGE VOLUME IS 0.891 x 10<sup>-5</sup> IN<sup>3</sup> REF.
- FOR VITA REQUIREMENTS, -A PIN SHOULD NOT BE ORDERED, 6X19 ONLY.
- MAXIMUM ROW TO ROW VARIATION .003[0.08], MEASURED FIRST & LAST POSITIONS ONLY, ALL ROWS.
- THESE OPTIONS AVAILABLE AS ASO (APPLICATION SPECIFIC OPTIONS) ONLY. PLEASE CONTACT SAMTEC FOR MORE INFORMATION.

No OF POSITIONS

- ⊖ -10, ⊠ -15, \*\* -19 -20,
- ⊓ -25, -30, -40, -50
- (PER ROW)

LEAD STYLE

- 02.0 (SEE TABLE 1)
- 03.0 (SEE TABLE 1)
- 03.5 (SEE TABLE 1)
- \*\*\*-05.5 (SEE TABLE 1)
- \*\*\*\*-06.5 (SEE TABLE 8, SHT 3) (SEE NOTE 14)
- 07.0 (SEE TABLE 8, SHT 3)
- 09.0 (SEE TABLE 8, SHT 3)
- 11.0 (SEE TABLE 8, SHT 3)
- \*-13.0 (SEE TABLE 8, SHT 3)

PLATING SPECIFICATION

- L: 10μ" LIGHT GOLD IN CONTACT AREA, MATTE TIN ON TAIL
- (LEAD STYLE -02.0 THRU-05.5: USE NEW-SUB-T-1M36-XX.X-L-X)
- (LEAD STYLE -06.5 THRU-13.0: USE NEW-SUB-T-1M38-XX.X-L-X)
- SM: 30μ" SELECTIVE GOLD IN CONTACT AREA, MATTE TIN ON TAIL
- (LEAD STYLE -02.0 THRU-05.5: USE NEW-SUB-T-1M36-XX.X-S-X)
- (LEAD STYLE -06.5 THRU-13.0: USE NEW-SUB-T-1M38-XX.X-S-X)
- S: 30μ" SELECTIVE GOLD IN CONTACT AREA, MATTE TIN ON TAIL
- (LEAD STYLE -02.0 THRU-05.5: USE NEW-SUB-T-1M36-XX.X-S-X)
- (LEAD STYLE -06.5 THRU-13.0: USE NEW-SUB-T-1M38-XX.X-S-X)

ROW

- 04: 4 ROWS (SEE FIG 3, SHT 4) (NOT AVAILABLE IN -13.0 LEAD STYLE)
- 05: 5 ROWS (SEE FIG 7, SHT 5) (SEE NOTE 14)
- 06: 6 ROWS (SEE FIG 6, SHT 5)
- 08: 8 ROWS (SEE FIG 1)
- 10: 10 ROWS (SEE FIG 4, SHT 4)

No. OF ROWS	"G"
-04	.079 [2.01]
-05, -06	.120 [3.05]
-08	.120 [3.05]
-10	.120 [3.05]

- \* = NOT TOOLED
- ⊖ = 10 POSITION ONLY AVAILABLE IN 4 ROW
- ⊠ = ONLY AVAILABLE IN A 10 ROW
- ⊓ = ONLY AVAILABLE WITH -02.0 OR -03.5 LEAD STYLE & 4 ROW
- \*\* = ONLY AVAILABLE IN 6 ROW WITH -03.5 OR -05.5 LEAD STYLE
- \*\*\* = ONLY AVAILABLE WITH 19 POSITION, 6 ROWS
- \*\*\*\* = ONLY AVAILABLE IN 8 & 10 ROW

STYLE	"H"	"J"	BODY CALLOUT	TERMINAL	
				SOLDER CHARGE TAIL	SOLDER CRIMP TAIL
-02.0	.221 [5.61]	.073 [1.85]	SEAM-XX-02.0-XX-X	NEW-SUB-T-1M36-02.0-X-X	SUB-T-1M85-02.0-XX
-03.0	.260 [6.60]	.112 [2.84]	SEAM-XX-03.0-XX-X	NEW-SUB-T-1M36-03.0-X-X	SUB-T-1M85-03.0-X-X
-03.5	.280 [7.11]	.132 [3.35]	SEAM-XX-03.5-XX-X	NEW-SUB-T-1M36-03.5-X-X	SUB-T-1M85-03.5-XX
-05.5	.359 [9.12]	.211 [5.35]	SEAM-XX-05.5-XX-X	NEW-SUB-T-1M36-05.5-X-X	SUB-T-1M85-05.5-X-X

(SEE SHEET 3 FOR LEAD STYLES -06.5 THRU -13.0)

UNLESS OTHERWISE SPECIFIED, DIMENSIONS ARE IN INCHES.

TOLERANCES ARE:  
DECIMALS ANGLES  
.XX: ±.01 [3]  
.XXX: ±.005 [13]  
.XXXX: ±.0020 [051]

PROPRIETARY NOTE

THIS DOCUMENT CONTAINS INFORMATION CONFIDENTIAL AND PROPRIETARY TO SAMTEC, INC. AND SHALL NOT BE REPRODUCED OR TRANSFERRED TO OTHER DOCUMENTS OR DISCLOSED TO OTHERS OR USED FOR ANY PURPOSE OTHER THAN THAT WHICH IT WAS OBTAINED WITHOUT THE EXPRESSED WRITTEN CONSENT OF SAMTEC, INC.

MATERIAL: DO NOT SCALE DRAWING SHEET SCALE: 2:1  
INSULATOR: LCP, COLOR: BLACK  
TERMINAL: COPPER ALLOY

DESCRIPTION:  
.050 PITCH TERMINAL ARRAY ASSEMBLY

DWG. NO.  
**SEAM-XX-XX.X-XX-XX-X-A-XX-K-TR**

BY: BRATCHER 08-09-2010 SHEET 1 OF 7

TAPE & REEL  
(SEE NOTES 8, 9 & 10)

K DOT

- (SEE FIG 5, SHT 4) (SEE NOTE 7)
- DOT APPLICATOR-KAPTON TAPE.
- 04 ROW: USE K-DOT-.236-.343-.005
- 05/-06 ROW: USE K-DOT-.236-.343-.005
- 08 ROW: USE K-DOT-.325-.450-.005
- 10 ROW: USE K-DOT-.404-.500-.005

OPTION

- GP: GUIDE POST (SEE FIG. 9, SHT 6) (ONLY AVAILABLE WITH -02.0 LEAD STYLE, 20, 30, 40, & 50 POSITION)
- EP: EXTENDED GUIDE POST (SEE FIG. 10, SHT 6) (ONLY AVAILABLE WITH -02.0 & -03.5 LEAD STYLE, 20, 30, 40, & 50 POSITION)

ALIGNMENT PIN  
(SEE NOTE 6 & T2)

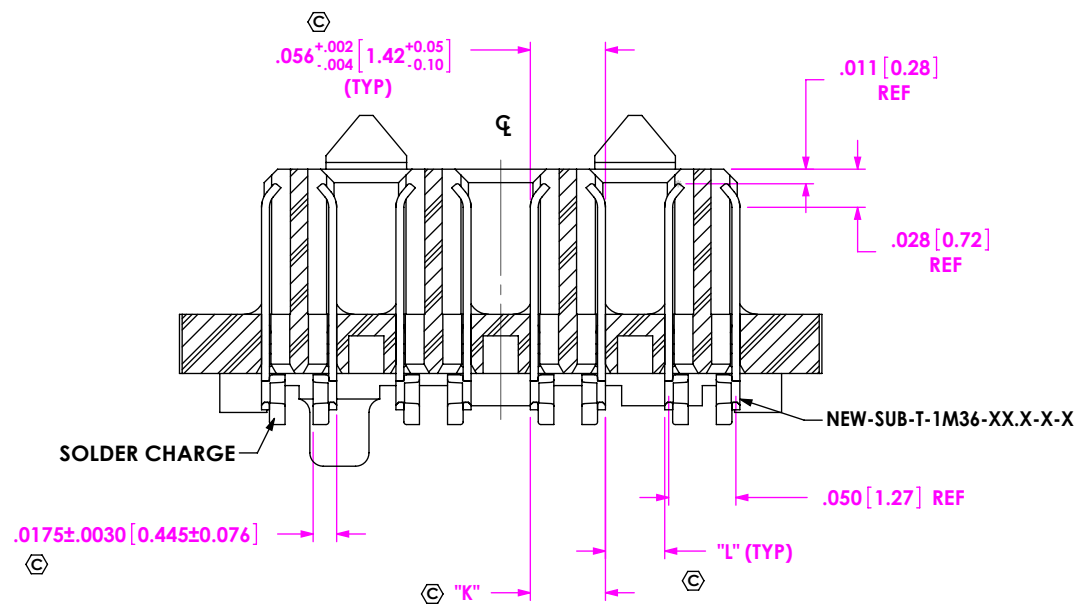
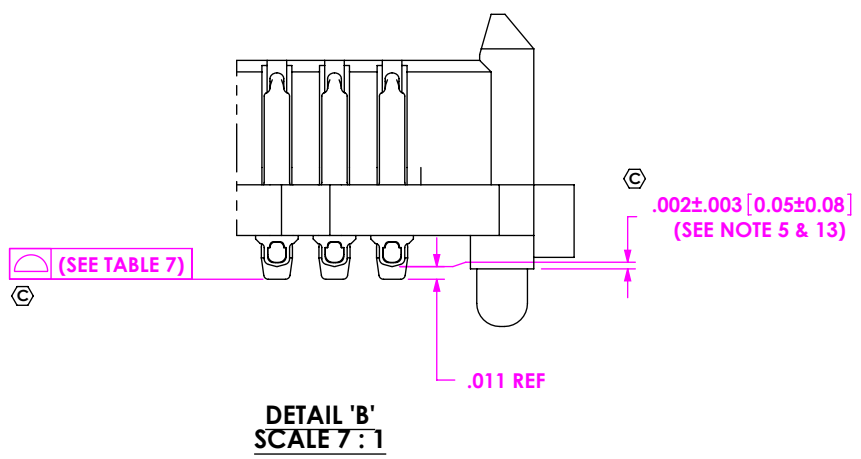
SOLDER COMPOSITION & STYLE ⊙

- 1: 63% TIN / 37% LEAD CHARGE TAIL (USE NEW-SUB-T-1M3X-XX.X-X-1)
- 2: 95.5% TIN / 3.8% SILVER / .7% COPPER CHARGE TAIL (USE NEW-SUB-T-1M3X-XX.X-X-2)
- ⊙-3: 63% TIN / 37% LEAD CRIMP TAIL (USE SUB-T-1M85-XX.X-X-1) (SEE FIG 11, SHT 7) (ONLY AVAILABLE ON -02.0, -03.0 & -03.5 LEAD STYLES)
- ⊙-4: 95.5% TIN / 3.8% SILVER / .7% COPPER CRIMP TAIL (USE SUB-T-1M85-XX.X-X-2) (SEE FIG 11, SHT 7) (ONLY AVAILABLE ON -02.0, -03.0 & -03.5 LEAD STYLES)

⊙ = AVAILABLE TO EXISTING CUSTOMERS ONLY.



520 PARK EAST BLVD, NEW ALBANY, IN 47150  
PHONE: 812-944-6733 FAX: 812-948-5047  
e-Mail info@SAMTEC.com code 53322



**TABLE 3**  
STACK HEIGHT

SEAM LEAD STYLE	SEAF LEAD STYLE			
	-05.0	-06.0	-06.5	-07.5
-02.0	7mm	8mm	8.5mm	9.5mm
-03.0	8mm	9mm	9.5mm	10.5mm
-03.5	8.5mm	9.5mm	10mm	11mm
-05.5	NA	NA	12mm	NA
-06.5	11.5mm	12.5mm	13mm	14mm
-07.0	12mm	13mm	13.5mm	14.5mm
-09.0	14mm	15mm	15.5mm	16.5mm
-11.0	16mm	17mm	17.5mm	18.5mm
*-13.0	18mm	19mm	19.5mm	20.5mm

(\* = NOT TOOLED)

**TABLE 5**

LEAD STYLE	"K"	"L"
-02.0	.0530 - .0590 [1.346] - [1.499]	.0470 - .0410 [1.194] - [1.041]
-03.0	.0530 - .0620 [1.346] - [1.575]	.0470 - .0380 [1.194] - [0.965]
-03.5	.0530 - .0645 [1.346] - [1.638]	.0470 - .0355 [1.194] - [0.902]
-05.5	.0530 - .0645 [1.346] - [1.638]	.0470 - .0355 [1.194] - [0.902]

**TABLE 6**

No. OF POS	"A"	"B"	"C"	"D"	"E"	"F"
□-10	.696 [17.68]	.622 [15.80]	9	.4500 [11.430]	.4500 [11.430]	.641 [16.28]
⊠-15	.946 [24.03]	.872 [22.15]	14	.7000 [17.780]	.7000 [17.780]	.891 [22.63]
**19	1.146 [29.11]	1.072 [27.23]	18	.9000 [22.860]	.9000 [22.860]	1.091 [27.71]
-20	1.196 [30.38]	1.122 [28.50]	19	.9500 [24.130]	.9500 [24.130]	1.141 [28.98]
△-25	1.446 [36.73]	1.372 [34.85]	24	1.2000 [30.480]	1.2000 [30.480]	1.391 [35.33]
-30	1.696 [43.08]	1.622 [41.20]	29	1.4500 [36.830]	1.4500 [36.830]	1.641 [41.68]
-40	2.196 [55.78]	2.122 [53.90]	39	1.9500 [49.530]	1.9500 [49.530]	2.141 [54.38]
-50	2.696 [68.48]	2.622 [66.60]	49	2.4500 [62.230]	2.4500 [62.230]	2.641 [67.08]

**TABLE 7**

LEAD STYLE	10-30 POS.	40 POS.	50 POS.
-02.0, -03.0, -03.5, -05.5, -06.5, -07.0, -09.0, *-13.0	.006 [0.152]	.009 [0.229]	.009 [0.229]
-11.0	.0085 [0.216]		

(\* = NOT TOOLED)

**PROPRIETARY NOTE**  
THIS DOCUMENT CONTAINS INFORMATION CONFIDENTIAL AND PROPRIETARY TO SAMTEC, INC. AND SHALL NOT BE REPRODUCED OR TRANSFERRED TO OTHER DOCUMENTS OR DISCLOSED TO OTHERS OR USED FOR ANY PURPOSE OTHER THAN THAT WHICH IT WAS OBTAINED WITHOUT THE EXPRESSED WRITTEN CONSENT OF SAMTEC, INC.

DO NOT SCALE DRAWING

SHEET SCALE: 2:1



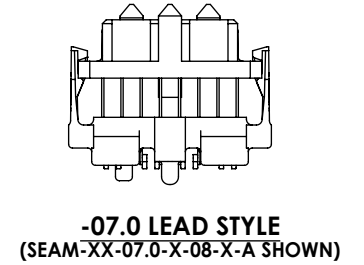
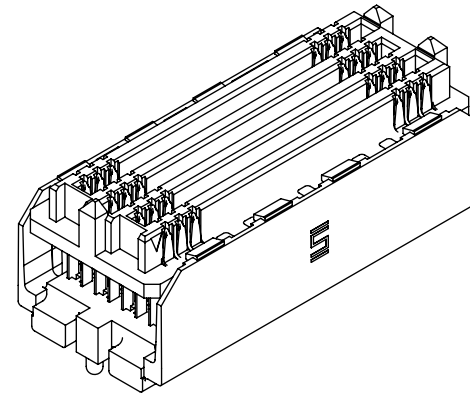
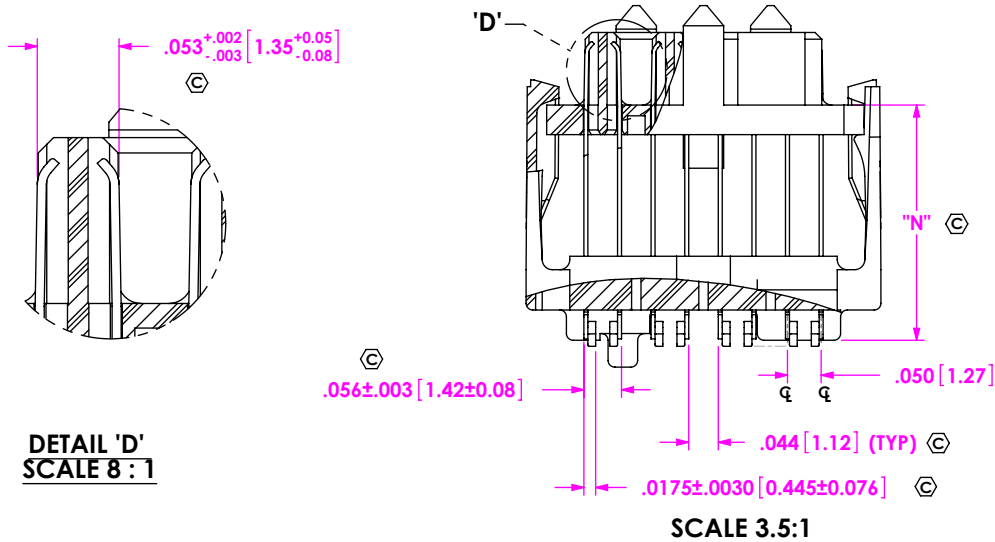
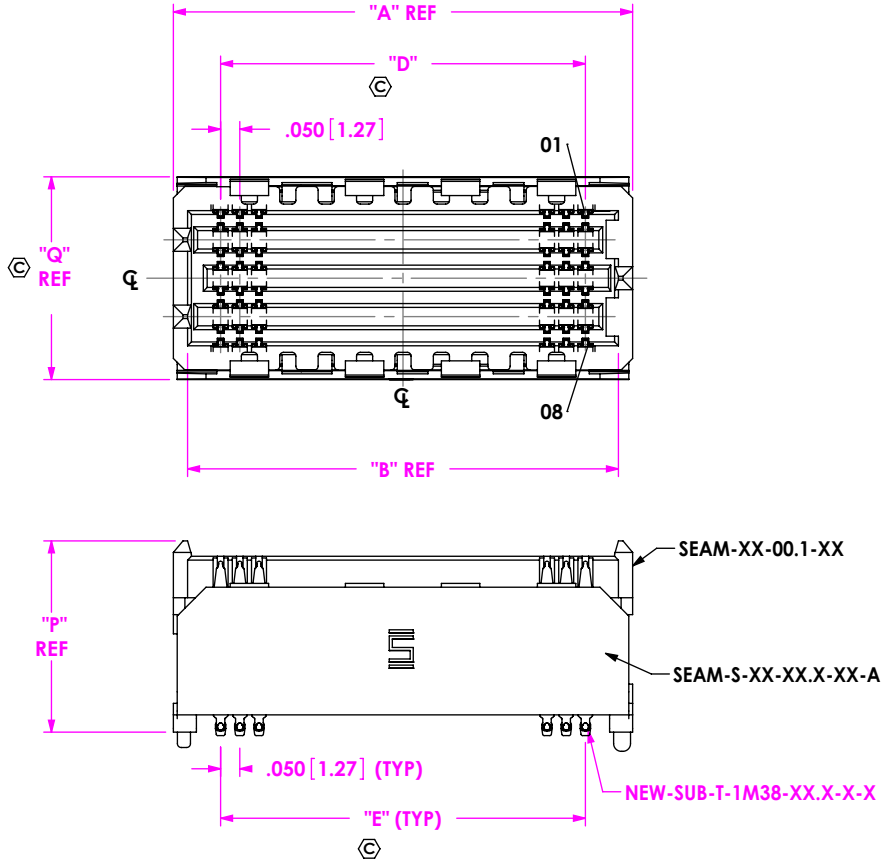
520 PARK EAST BLVD, NEW ALBANY, IN 47150  
PHONE: 812-944-6733 FAX: 812-948-5047  
e-Mail info@SAMTEC.com code 55322

DESCRIPTION:  
**.050 PITCH TERMINAL ARRAY ASSEMBLY**

DWG. NO.  
**SEAM-XX-XX.X-XX-XX-X-A-XX-K-TR**

BY: BRATCHER 08-09-2010 SHEET 2 OF 7

**FIG 2**  
 -06.5 THRU -13.0 LEAD STYLES  
 (SEAM-20-09.0-XX-08-1-A SHOWN)  
 (SAME AS FIG 1, EXCEPT AS SHOWN)  
 (SOME CENTER FEATURES REMOVED FOR CLARITY)



**TABLE 8**


ROW	STYLE	"N"	"P"	"Q"	SPACER BODY	TOP BODY	TERMINAL
-04	-07.0	.271 [6.88]	.417 [10.59]	.328 [8.33]	SEAM-S-XX-07.0-04-A	SEAM-XX-00.1-04	NEW-SUB-T-1M38-07.0-X-X
	-09.0	.350 [8.89]	.496 [12.60]	.328 [8.33]	SEAM-S-XX-09.0-04-A	SEAM-XX-00.1-04	NEW-SUB-T-1M38-09.0-X-X
	-11.0	.429 [10.90]	.575 [14.61]	.328 [8.33]	SEAM-S-XX-11.0-04-A	SEAM-XX-00.1-04	NEW-SUB-T-1M38-11.0-X-X
-05	-07.0	.271 [6.88]	.417 [10.59]	.428 [10.87]	SEAM-S-XX-07.0-06-A	SEAM-XX-00.1-05	NEW-SUB-T-1M38-07.0-X-X
	-09.0	.350 [8.89]	.496 [12.60]	.428 [10.87]	SEAM-S-XX-09.0-06-A	SEAM-XX-00.1-05	NEW-SUB-T-1M38-09.0-X-X
	-11.0	.429 [10.90]	.575 [14.61]	.428 [10.87]	SEAM-S-XX-11.0-06-A	SEAM-XX-00.1-05	NEW-SUB-T-1M38-11.0-X-X
	*-13.0	.508 [12.90]	.654 [16.61]	.428 [10.87]	SEAM-S-XX-13.0-06-A	SEAM-XX-00.1-05	NEW-SUB-T-1M38-13.0-X-X
-06	-07.0	.271 [6.88]	.417 [10.59]	.428 [10.87]	SEAM-S-XX-07.0-06-A	SEAM-XX-00.1-06	NEW-SUB-T-1M38-07.0-X-X
	-09.0	.350 [8.89]	.496 [12.60]	.428 [10.87]	SEAM-S-XX-09.0-06-A	SEAM-XX-00.1-06	NEW-SUB-T-1M38-09.0-X-X
	-11.0	.429 [10.90]	.575 [14.61]	.428 [10.87]	SEAM-S-XX-11.0-06-A	SEAM-XX-00.1-06	NEW-SUB-T-1M38-11.0-X-X
	*-13.0	.508 [12.90]	.654 [16.61]	.428 [10.87]	SEAM-S-XX-13.0-06-A	SEAM-XX-00.1-06	NEW-SUB-T-1M38-13.0-X-X
-08	-06.5	.252 [6.40]	.400 [10.16]	.528 [13.41]	SEAM-S-XX-06.5-08-A	SEAM-XX-00.1-08	NEW-SUB-T-1M38-06.5-X-X
	-07.0	.271 [6.88]	.417 [10.59]	.528 [13.41]	SEAM-S-XX-07.0-08-A	SEAM-XX-00.1-08	NEW-SUB-T-1M38-07.0-X-X
	-09.0	.350 [8.89]	.496 [12.60]	.528 [13.41]	SEAM-S-XX-09.0-08-A	SEAM-XX-00.1-08	NEW-SUB-T-1M38-09.0-X-X
	-11.0	.429 [10.90]	.575 [14.61]	.528 [13.41]	SEAM-S-XX-11.0-08-A	SEAM-XX-00.1-08	NEW-SUB-T-1M38-11.0-X-X
	*-13.0	.508 [12.90]	.654 [16.61]	.528 [13.41]	SEAM-S-XX-13.0-08-A	SEAM-XX-00.1-08	NEW-SUB-T-1M38-13.0-X-X
-10	-06.5	.252 [6.40]	.400 [10.16]	.628 [15.95]	SEAM-S-XX-06.5-10-A	SEAM-XX-00.1-10	NEW-SUB-T-1M38-06.5-X-X
	-07.0	.271 [6.88]	.417 [10.59]	.628 [15.95]	SEAM-S-XX-07.0-10-A	SEAM-XX-00.1-10	NEW-SUB-T-1M38-07.0-X-X
	-09.0	.350 [8.89]	.496 [12.60]	.628 [15.95]	SEAM-S-XX-09.0-10-A	SEAM-XX-00.1-10	NEW-SUB-T-1M38-09.0-X-X
	-11.0	.429 [10.90]	.575 [14.61]	.628 [15.95]	SEAM-S-XX-11.0-10-A	SEAM-XX-00.1-10	NEW-SUB-T-1M38-11.0-X-X
	*-13.0	.508 [12.90]	.654 [16.61]	.628 [15.95]	SEAM-S-XX-13.0-10-A	SEAM-XX-00.1-10	NEW-SUB-T-1M38-13.0-X-X

(\* = NOT TOOLED)

**PROPRIETARY NOTE**  
 THIS DOCUMENT CONTAINS INFORMATION CONFIDENTIAL AND PROPRIETARY TO SAMTEC, INC. AND SHALL NOT BE REPRODUCED OR TRANSFERRED TO OTHER DOCUMENTS OR DISCLOSED TO OTHERS OR USED FOR ANY PURPOSE OTHER THAN THAT WHICH IT WAS OBTAINED WITHOUT THE EXPRESSED WRITTEN CONSENT OF SAMTEC, INC.

DO NOT SCALE DRAWING

SHEET SCALE: 2:1

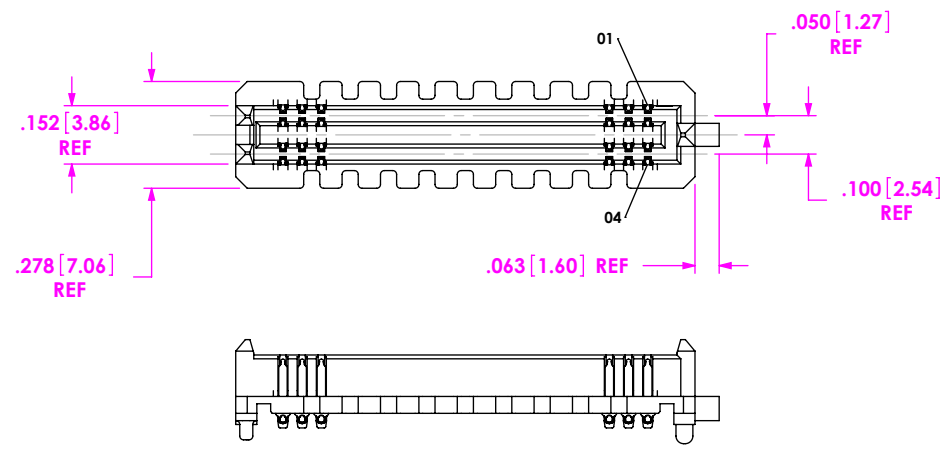
  
 520 PARK EAST BLVD, NEW ALBANY, IN 47150  
 PHONE: 812-944-6733 FAX: 812-948-5047  
 e-Mail info@SAMTEC.com code 55322

DESCRIPTION:  
**.050 PITCH TERMINAL ARRAY ASSEMBLY**

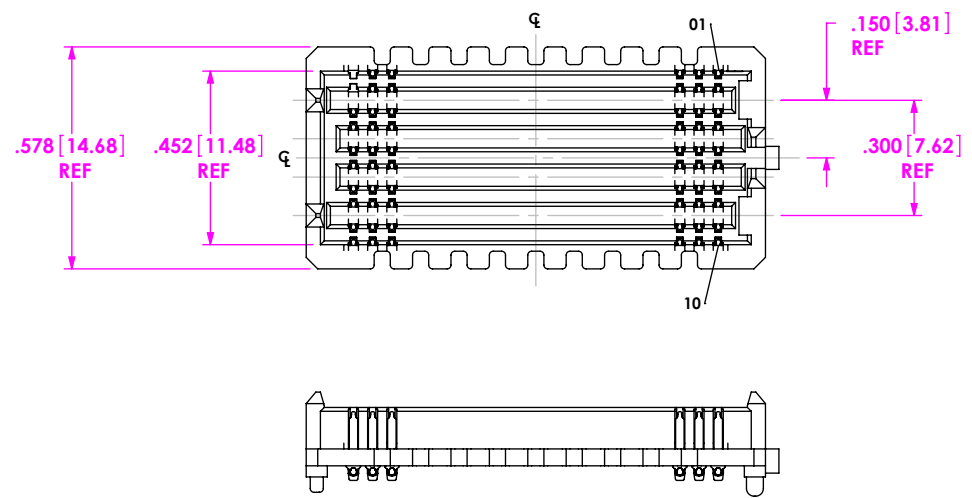
DWG. NO.  
**SEAM-XX-XX.X-XX-XX-X-A-XX-K-TR**

BY: BRATCHER 08-09-2010 SHEET 3 OF 7

**FIG 3**  
 -04: 4 ROW  
 (SEAM-20-02.0-XX-04-1-A SHOWN)  
 (SAME AS FIG 1, EXCEPT AS SHOWN)  
 (SOME CENTER FEATURES REMOVED FOR CLARITY)



**FIG 4**  
 -10: 10 ROW  
 (SEAM-20-02.0-XX-10-1-A SHOWN)  
 (SAME AS FIG 1, EXCEPT AS SHOWN)  
 (SOME CENTER FEATURES REMOVED FOR CLARITY)



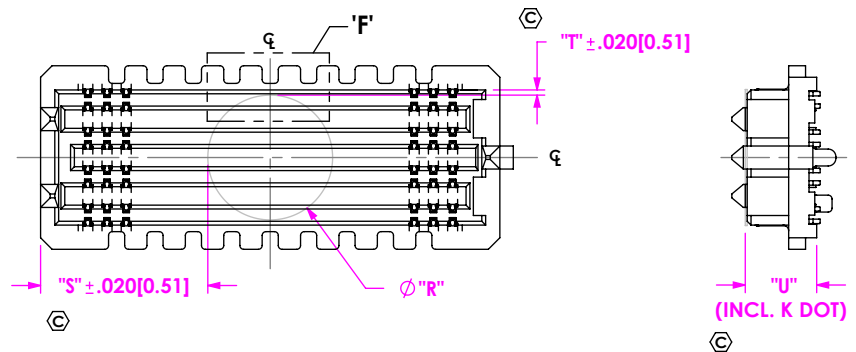
**TABLE 9**

ROW	Ø "R"	"S"								"T"
		□ 10 POS	⊠ 15 POS	** 19 POS	20 POS	△ 25 POS	30 POS	40 POS	50 POS	
-04	.236 [6.00]	.230 [5.84]	.355 [9.01]	.455 [11.55]	.480 [12.19]	.605 [15.36]	.730 [18.54]	.980 [24.89]	1.230 [31.24]	.042 [1.07]
-05, -06	.236 [6.00]	.230 [5.84]	.355 [9.02]	.455 [11.56]	.480 [12.19]	.605 [15.37]	.730 [18.54]	.980 [24.89]	1.230 [31.24]	.008 [0.20]
-08	.325 [8.25]	.186 [4.71]	.222 [5.65]	.411 [10.43]	.436 [11.06]	.561 [14.24]	.686 [17.41]	.936 [23.76]	1.186 [30.11]	.014 [0.36]
-10	.404 [10.25]	.146 [3.71]	.271 [6.89]	.371 [9.43]	.396 [10.06]	.521 [13.24]	.646 [16.41]	.896 [22.76]	1.146 [29.11]	.024 [0.61]

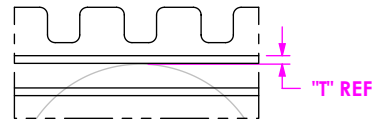
**TABLE 10**

LEAD STYLE	"U"
-02.0	.186 [4.72]
-03.0	.225 [5.72]
-03.5	.245 [6.22]
-05.5	.324 [8.23]
-06.5	.365 [9.27]
-07.0	.382 [9.70]
-09.0	.461 [11.71]
-11.0	.540 [13.72]
*-13.0	.619 [15.72]

(\* = NOT TOOLED)



**FIG 5**  
 -K: K DOT  
 (SEAM-20-02.0-XX-08-1-A-K SHOWN)  
 (SAME AS FIG 1, EXCEPT AS SHOWN)  
 (SOME CENTER FEATURES REMOVED FOR CLARITY)



**DETAIL 'F'**  
 SCALE 4:1

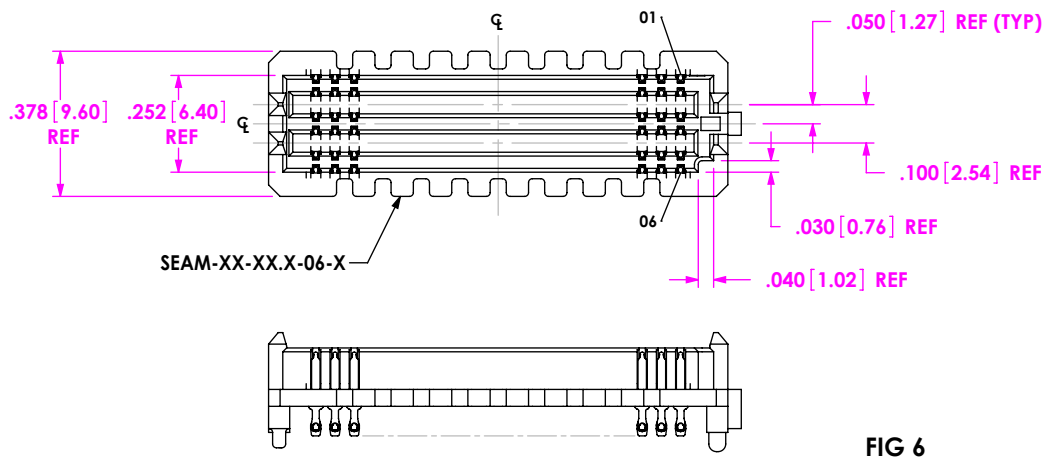
**PROPRIETARY NOTE**  
 THIS DOCUMENT CONTAINS INFORMATION CONFIDENTIAL AND PROPRIETARY TO SAMTEC, INC. AND SHALL NOT BE REPRODUCED OR TRANSFERRED TO OTHER DOCUMENTS OR DISCLOSED TO OTHERS OR USED FOR ANY PURPOSE OTHER THAN THAT WHICH IT WAS OBTAINED WITHOUT THE EXPRESSED WRITTEN CONSENT OF SAMTEC, INC.

DO NOT SCALE DRAWING  
 SHEET SCALE:2:1



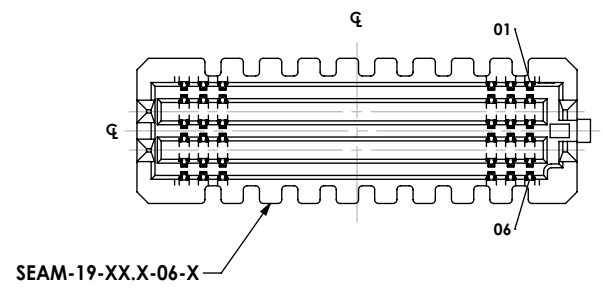
520 PARK EAST BLVD, NEW ALBANY, IN 47150  
 PHONE: 812-944-6733 FAX: 812-948-5047  
 e-Mail info@SAMTEC.com code 55322

DESCRIPTION:  
**.050 PITCH TERMINAL ARRAY ASSEMBLY**  
 DWG. NO.  
**SEAM-XX-XX.X-XX-XX-X-A-XX-K-TR**  
 BY: BRATCHER 08-09-2010 SHEET 4 OF 7

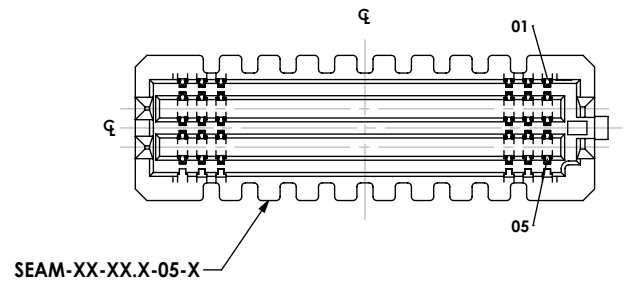


**FIG 6**  
 -06: 6 ROWS  
 (SEAM-20-03.0-XX-06-1-A SHOWN)  
 (SAME AS FIG 1, EXCEPT AS SHOWN)  
 (SOME CENTER FEATURES REMOVED FOR CLARITY)

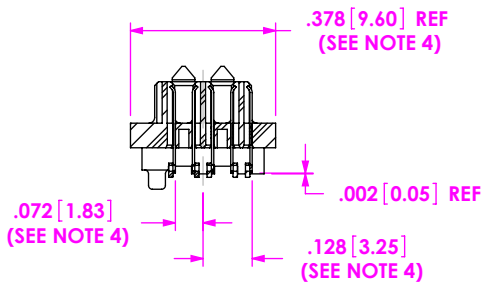
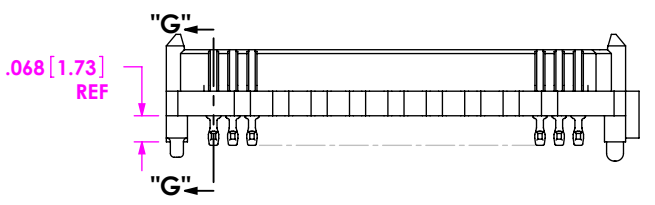
**FIG 8**  
 -19: 19 POSITIONS  
 (SEAM-19-05.5-XX-06-1 SHOWN)  
 (ONLY AVAILABLE IN -06 ROW WITH -03.5 OR -05.5 LEAD STYLE)  
 (SAME AS FIG 6, EXCEPT AS SHOWN)  
 (SOME CENTER FEATURES REMOVED FOR CLARITY)  
 (SEE NOTE 12)



SEAM-19-XX.X-06-X

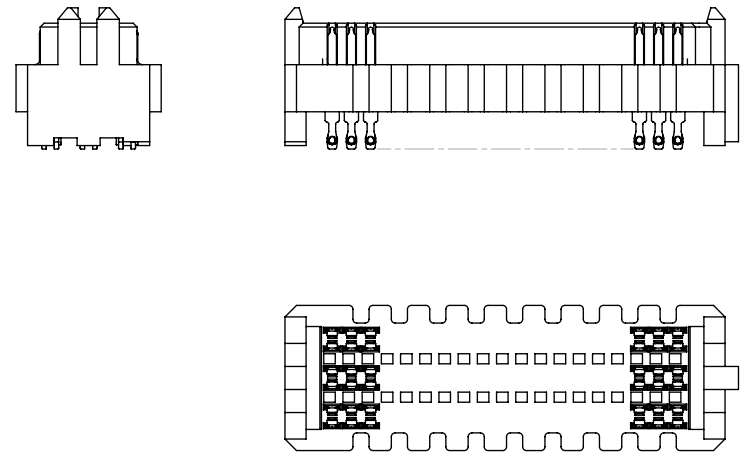
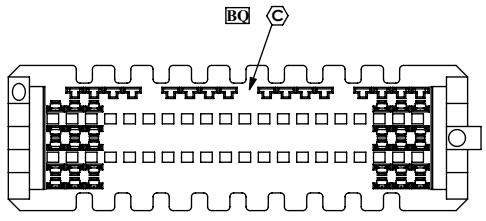


SEAM-XX-XX.X-05-X



**SECTION "G"-"G"**

**FIG 7**  
 -05: 5 ROWS  
 (SEAM-20-03.5-XX-05-1-A SHOWN)  
 (SAME AS FIG 6, EXCEPT AS SHOWN)  
 (SOME CENTER FEATURES REMOVED FOR CLARITY)  
 (SEE NOTE 4)



**PROPRIETARY NOTE**  
 THIS DOCUMENT CONTAINS INFORMATION CONFIDENTIAL AND PROPRIETARY TO SAMTEC, INC. AND SHALL NOT BE REPRODUCED OR TRANSFERRED TO OTHER DOCUMENTS OR DISCLOSED TO OTHERS OR USED FOR ANY PURPOSE OTHER THAN THAT WHICH IT WAS OBTAINED WITHOUT THE EXPRESSED WRITTEN CONSENT OF SAMTEC, INC.

DO NOT SCALE DRAWING  
 SHEET SCALE: 2:1



520 PARK EAST BLVD, NEW ALBANY, IN 47150  
 PHONE: 812-944-6733 FAX: 812-948-5047  
 e-Mail info@SAMTEC.com code 55322

DESCRIPTION:  
**.050 PITCH TERMINAL ARRAY ASSEMBLY**

DWG. NO.  
**SEAM-XX-XX.X-XX-XX-X-A-XX-K-TR**

BY: BRATCHER 08-09-2010 SHEET 5 OF 7

**FIG 9**  
 -GP: GUIDE POST OPTION  
 (ONLY AVAILABLE WITH -.02.0 LEAD STYLE, 20, 30, 40, & 50 POSITIONS)  
 (MATES WITH SEAF RIGHT ANGLE ONLY)  
 (SEAM-20-02.0-XX-06-1-A-GP SHOWN)  
 (SAME AS FIG 1, EXCEPT AS SHOWN)  
 (SOME CENTER FEATURES REMOVED FOR CLARITY)

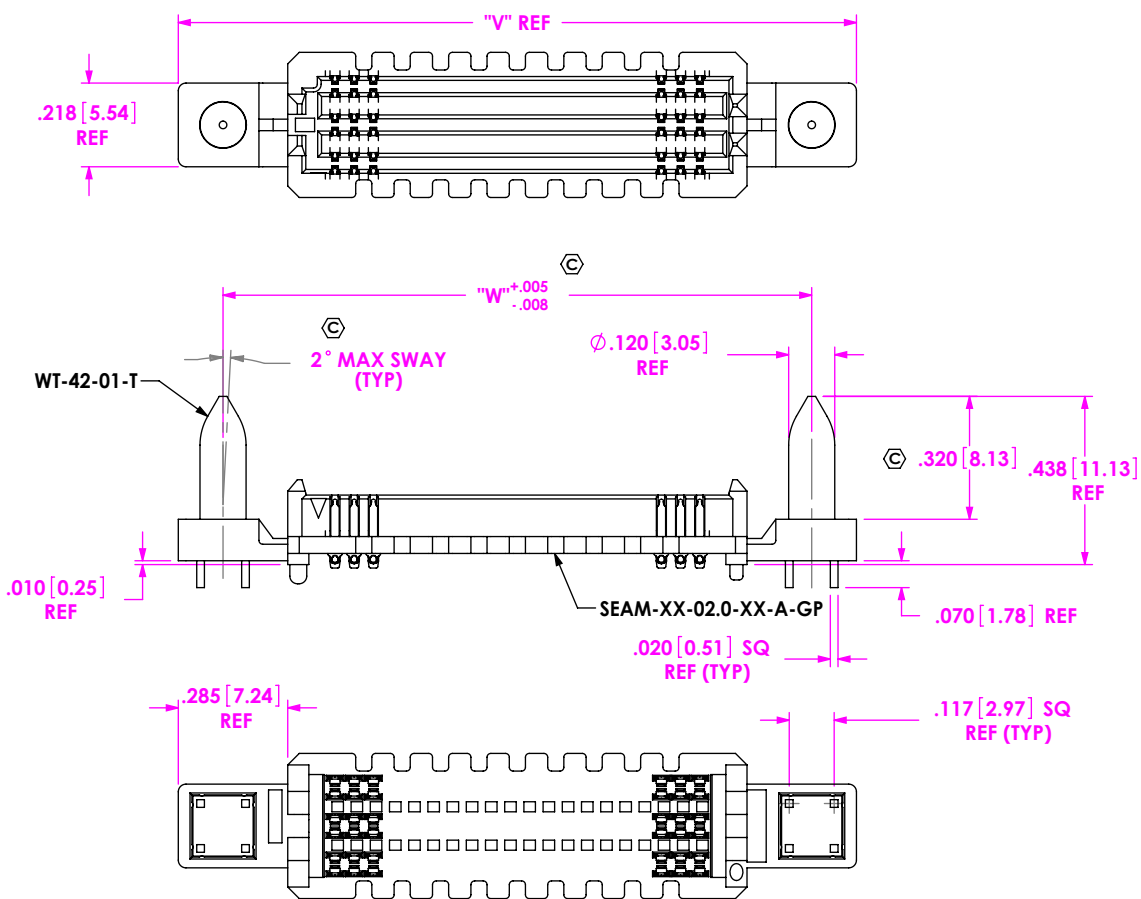


TABLE 10

POSITIONS	"V"	"W"
-20	1.766 [44.86]	1.533 [38.94]
-30	2.266 [57.56]	2.033 [51.64]
-40	2.766 [70.26]	2.533 [64.34]
-50	3.266 [82.96]	3.033 [77.04]

**FIG 10**  
 -EP: EXTENDED GUIDE POST OPTION  
 (ONLY AVAILABLE WITH -.02.0 & -.03.5 LEAD STYLES,  
 20, 30, 40, & 50 POSITIONS)  
 (SEAM-20-03.5-XX-06-1-A-EP SHOWN)  
 (SAME AS FIG 9, EXCEPT AS SHOWN)  
 (SOME CENTER FEATURES REMOVED FOR CLARITY)

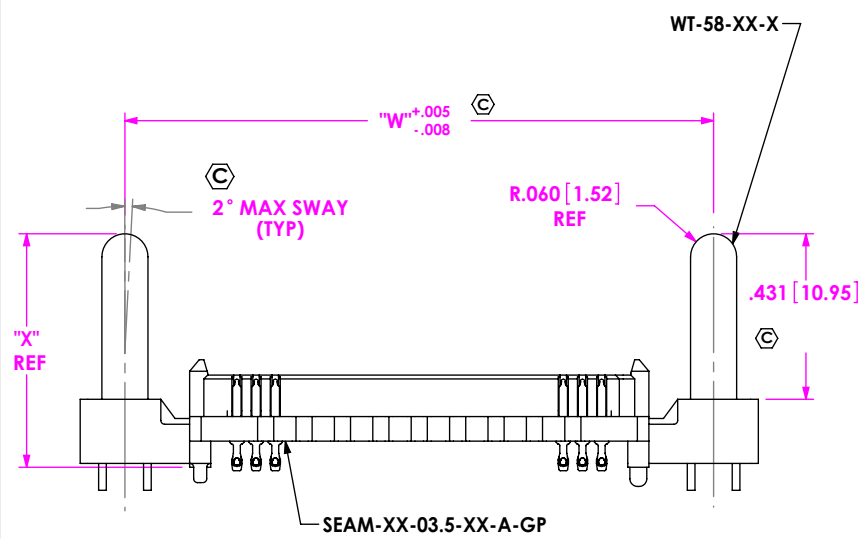


TABLE 11

LEAD STYLE	"X"	GUIDE POST
-02.0	.549 [13.94]	WT-58-01-T
-03.5	.608 [15.44]	WT-58-02-T

TABLE 12  
 -EP STACK HEIGHTS

SEAM LEAD STYLE	SEAF LEAD STYLE	STACK HEIGHT
-02.0	-05.0	7MM
-03.5	-06.5	10MM

**PROPRIETARY NOTE**  
 THIS DOCUMENT CONTAINS INFORMATION CONFIDENTIAL AND PROPRIETARY TO SAMTEC, INC. AND SHALL NOT BE REPRODUCED OR TRANSFERRED TO OTHER DOCUMENTS OR DISCLOSED TO OTHERS OR USED FOR ANY PURPOSE OTHER THAN THAT WHICH IT WAS OBTAINED WITHOUT THE EXPRESSED WRITTEN CONSENT OF SAMTEC, INC.



520 PARK EAST BLVD, NEW ALBANY, IN 47150  
 PHONE: 812-944-6733 FAX: 812-948-5047  
 e-Mail info@SAMTEC.com code 5322

DO NOT SCALE DRAWING

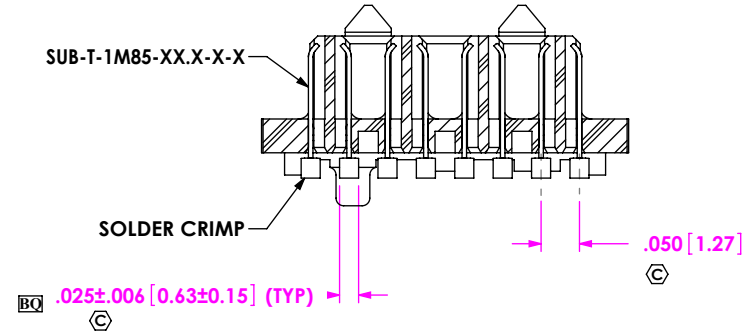
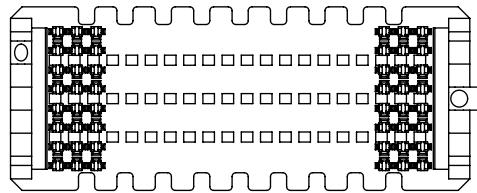
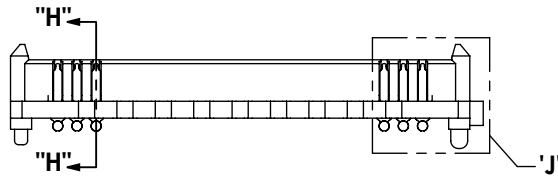
SHEET SCALE: 2:1

DESCRIPTION:  
**.050 PITCH TERMINAL ARRAY ASSEMBLY**

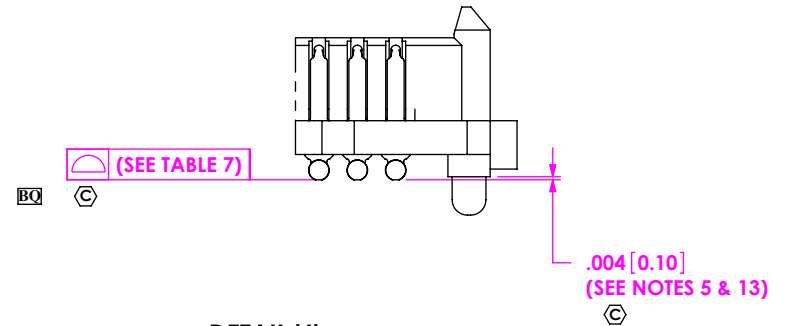
DWG. NO.  
**SEAM-XX-XX.X-XX-XX-X-A-XX-K-TR**

BY: BRATCHER 08-09-2010 SHEET 6 OF 7

**FIG 11**  
**CRIMP TAIL DETAILS**  
 (SEAM-20-02.0-XX-08-3-A SHOWN)  
 (ONLY AVAILABLE ON -.02.0, -.03.0 & -.03.5 LEAD STYLES)  
 (SAME AS FIG 1, EXCEPT AS SHOWN)  
 (SOME CENTER FEATURES REMOVED FOR CLARITY)



**SECTION "H"-"H"**  
**SCALE 4 : 1**



**DETAIL 'J'**  
**SCALE 4 : 1**

**PROPRIETARY NOTE**  
 THIS DOCUMENT CONTAINS INFORMATION  
 CONFIDENTIAL AND PROPRIETARY TO  
 SAMTEC, INC. AND SHALL NOT BE REPRODUCED  
 OR TRANSFERRED TO OTHER DOCUMENTS OR  
 DISCLOSED TO OTHERS OR USED FOR ANY  
 PURPOSE OTHER THAN THAT WHICH IT WAS  
 OBTAINED WITHOUT THE EXPRESSED WRITTEN  
 CONSENT OF SAMTEC, INC.

DO NOT SCALE DRAWING

SHEET SCALE: 2:1



520 PARK EAST BLVD, NEW ALBANY, IN 47150  
 PHONE: 812-944-6733 FAX: 812-948-5047  
 e-Mail info@SAMTEC.com code 55322

DESCRIPTION:  
**.050 PITCH TERMINAL ARRAY ASSEMBLY**

DWG. NO.  
**SEAM-XX-XX.X-XX-XX-X-A-XX-K-TR**

BY: BRATCHER 08-09-2010 SHEET 7 OF 7