

HLC1395

Reflective Sensor

FEATURES

- Side-looking plastic package
- Phototransistor output
- IR emitter and phototransistor detector in a single package
- Low profile for design flexibility
- Designed for short distance detection
- High sensitivity
- Unfocused for sensing diffused surfaces

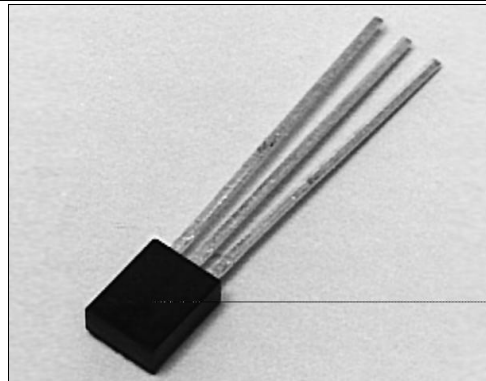

INFRA-58.TIF

DESCRIPTION

The HLC1395 is a miniature infrared sensor designed to sense reflective objects at short distances. Both the GaAs IRED and the NPN phototransistor are mounted side-by-side in a single black plastic package with an integral barrier to minimize crosstalk. The sensor is configured with the IRED cathode and the phototransistor emitter connected to a common lead.



The housing consists of an opaque polysulfone outer shell with transfer-molded, IR-transmissive epoxy encapsulant. Housings are soluble in chlorinated hydrocarbons and ketones. Recommended cleaning agents are methanol and isopropanol.

OUTLINE DIMENSIONS in inches (mm)

Tolerance 3 plc decimals ±0.010(0.25)
2 plc decimals ±0.030(0.76)

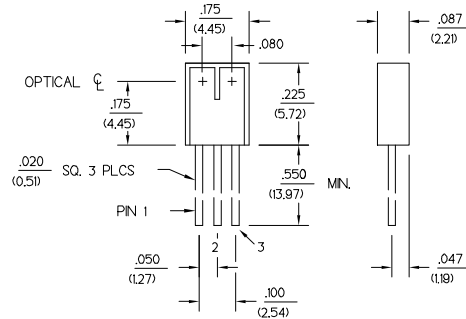

DIM_029.cdr

HLC1395

Reflective Sensor

ELECTRICAL CHARACTERISTICS (25°C unless otherwise noted)

PARAMETER	SYMBOL	MIN	TYP	MAX	UNITS	TEST CONDITIONS
IR EMITTER						
Forward Voltage	V_F			1.6	V	$I_F=20\text{ mA}$
Reverse Current	I_R			10	μA	$V_R=3\text{ V}$
DETECTOR						
Collector-Emitter Breakdown Voltage	$V_{(BR)CEO}$	30			V	$I_C=100\ \mu\text{A}$
Emitter-Collector Breakdown Voltage	$V_{(BR)ECO}$	5.0			V	$I_E=100\ \mu\text{A}$
Collector Dark Current	I_{CEO}			100	nA	$V_{CE}=10\text{ V}, I_F=0$
COUPLED CHARACTERISTICS						
On-State Collector Current	$I_{C(ON)}$				mA	$V_{CE}=5\text{ V}$
HLC1395-001		0.30				$I_F=10\text{ mA}$
HLC1395-002		0.60				(1)
Collector-Emitter Saturation Voltage	$V_{CE(SAT)}$			0.5	V	$I_C=40\ \mu\text{A}, I_F=10\text{ mA}$ (1)
Crosstalk (2)	I_{CX}			15	μA	$V_{CC}=5\text{ V}, I_F=10\text{ mA}$
Rise And Fall Time	t_r, t_f			15	μs	$V_{CC}=5\text{ V}, I_C=0.3\text{ mA}$ $R_L=1000\ \Omega$

Notes

1. Test surface is Eastman Kodak neutral white test card with 90% diffuse reflectance located 0.040 in. (1.0 mm) from the front surface of the device.
2. Crosstalk (I_{CX}) is the collector current measured with current to emitter and no reflecting surface.

ABSOLUTE MAXIMUM RATINGS

(25°C Free-Air Temperature unless otherwise noted)

Operating Temperature Range	-40°C to 85°C
Storage Temperature Range	-40°C to 85°C
Soldering Temperature (5 sec)	240°C

IR EMITTER

Reverse Voltage	3 V
Continuous Forward Current	50 mA
Power Dissipation	100 mW (1)

DETECTOR

Collector-Emitter Voltage	30 V
Emitter-Collector Voltage	5 V
Power Dissipation	100 mW (1)
Collector DC Current	30 mA

SCHEMATIC

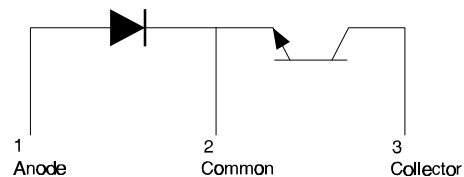

Honeywell reserves the right to make changes in order to improve design and supply the best products possible.

Honeywell

HLC1395

Reflective Sensor

Fig. 1 Normalized Light Current (I_L) vs Distance to Reflective Surface gra_071.ds4

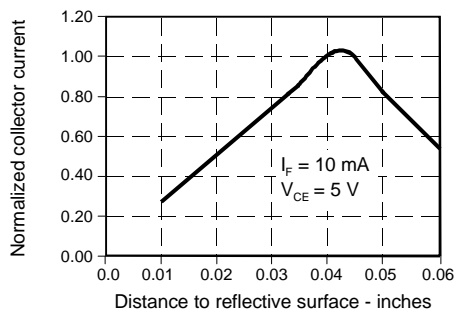

Fig. 2 Normalized Light Current (I_L) vs IRED Forward Current gra_072.ds4

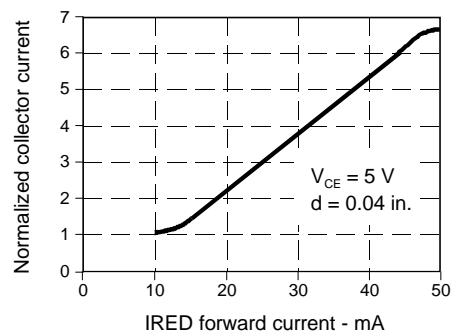

Fig. 3 IRED Forward Bias Characteristics gra_073.ds4

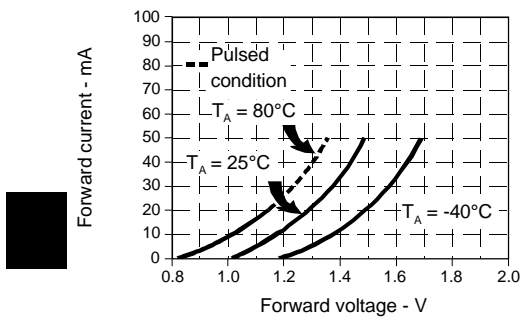

Fig. 4 Non-Saturated Switching Time vs Load Resistance gra_074.ds4

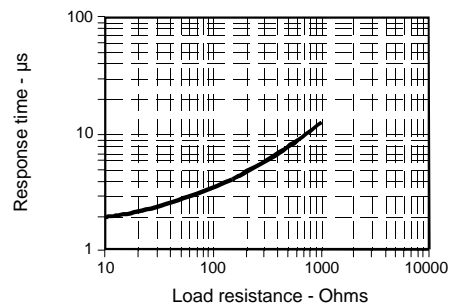

Fig. 5 Dark Current vs Temperature gra_301.cdr

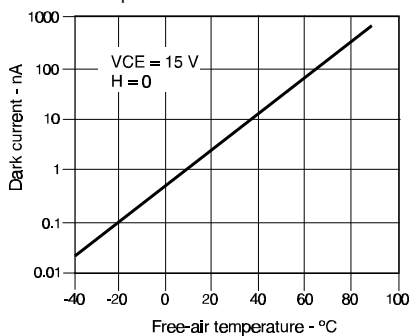
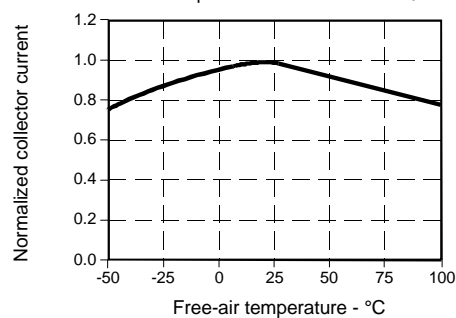

Fig. 6 Collector Current vs Ambient Temperature gra_076.ds4



All Performance Curves Show Typical Values

HLC1395

Reflective Sensor

