



### FEATURES

- Output voltages:  $\pm 5$ ,  $\pm 12$  or  $\pm 15$  Volts
- Input voltage ranges:  
10-18V, 18-36V or 36-75V
- Small packages, 1" x 2" x 0.48"
- Industry-standard pinouts
- Low cost; Highly reliable
- Proven SMT-on-pcb construction
- Designed to meet IEC/EN/UL60950-1 safety
- mark available (75V-input models)
- 1500Vdc isolation; 100% tested
- Efficiencies to 86%
- $-40$  to  $+100^{\circ}\text{C}$  operating temperature
- Thermal protection
- On/Off control

### PRODUCT OVERVIEW

For your mid-range power requirements, it's hard to beat the combination of small packaging, low cost, proven reliability and outstanding electrical performance offered by the 15-17W, dual-output models of MPS's A-Series DC/DC converters. These highly efficient, rugged converters combine straightforward circuit topologies, the newest components, proven SMT-on-pcb construction methods, and highly repeatable automatic-assembly techniques. Their superior durability is substantiated by a rigorous in-house qualification program.

The input voltage ranges of the BWR 15-17 Bipolar Series (10-18V for "D12A" models, 18-36V for "D24A" models and 36-75V for "D48A" models) make them excellent candidates for telecommunication system line drivers, or distributed power architectures. Their  $\pm 5$ ,  $\pm 12$  or  $\pm 15$  Volt outputs cover virtually all standard applications.

These popular power converters are fully isolated (1500Vdc 100% tested) and display excellent line and load regulation ( $\pm 0.5\%$  max. for line and load). They are completely I/O protected (input overvoltage shutdown and reverse-polarity protection, output current limiting and overvoltage protection) and contain input (pi type) and output filtering to reduce noise.

These extremely reliable, cost-effective power converters are housed in standard 1" x 2" x 0.48" UL94V-0 rated plastic packages. They offer industry-standard pinouts and are ideally suited for high-volume computer, telecom/datacom, instrumentation and ATE applications.

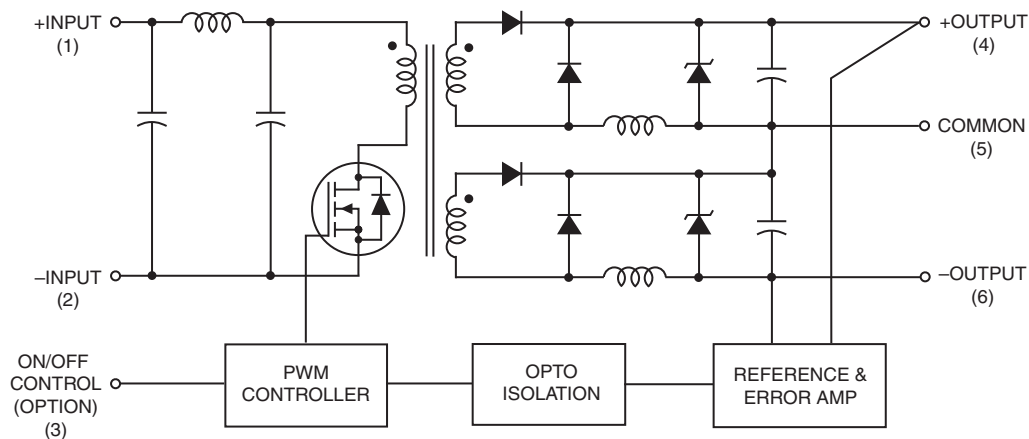

Figure 1. Simplified Schematic

Typical topology is shown



For full details go to  
[www.murata-ps.com/rohs](http://www.murata-ps.com/rohs)

**Performance Specifications and Ordering Guide** <sup>①</sup>

Root Model <sup>⑤</sup>	Output				Input			Efficiency		Package (Case, Pinout)		
	V <sub>out</sub> (Volts)	I <sub>out</sub> (mA)	R/N (mVp-p) <sup>②</sup>		Regulation (Max.)		V <sub>in</sub> Nom. (Volts)	Range (Volts)	I <sub>in</sub> <sup>④</sup> (mA/A)		Min.	Typ.
			Typ.	Max.	Line	Load <sup>③</sup>						
<b>OBSOLETE</b> * BWR-5/1500-D12A-C	±5	±1500	75	100	±0.5%	±0.5%	12	10-18	240/1.5	79%	81%	C14A, P43
BWR-5/1500-D24A-C	±5	±1500	75	100	±0.5%	±0.5%	24	18-36	112/0.75	81%	83%	C14A, P43
<b>OBSOLETE</b> * BWR-5/1500-D48A-C	±5	±1500	75	100	±0.5%	±0.5%	48	36-75	59/0.38	81%	83%	C14A, P43
<b>OBSOLETE</b> * BWR-12/725-D12A-C	±12	±725	75	100	±0.5%	±0.5%	12	10-18	265/1.7	82%	83.5%	C14A, P43
BWR-12/725-D24A-C	±12	±725	75	100	±0.5%	±0.5%	24	18-36	127/0.85	83%	85%	C14A, P43
<b>OBSOLETE</b> * BWR-12/725-D48A-C	±12	±725	75	100	±0.5%	±0.5%	48	36-75	62/0.4	84%	86%	C14A, P43
BWR-15/575-D12A-C	±15	±575	75	100	±0.5%	±0.5%	12	10-18	266/1.7	82%	84%	C14A, P43
BWR-15/575-D24A-C	±15	±575	75	100	±0.5%	±0.5%	24	18-36	125/0.84	84%	86%	C14A, P43
<b>OBSOLETE</b> * BWR-15/575-D48A-C	±15	±575	75	100	±0.5%	±0.5%	48	36-75	65/0.41	85%	87%	C14A, P43

**\* LAST TIME BUY: AUGUST 31, 2014. CLICK HERE FOR OBSOLESCENCE NOTICE OF FEBRUARY 2014.**

- ① Typical at T<sub>A</sub> = +25°C under nominal line voltage and full-load conditions unless otherwise noted.
- ② Ripple/Noise (R/N) measured over a 20MHz bandwidth.
- ③ Balanced loads, 10% to 100% load step.
- ④ Nominal line voltage, 10% load/100% load conditions.
- ⑤ These are not complete model numbers. Please use the part number structure when ordering.

**As of September 2014, ONLY the following part numbers will be available: BWR-5/1500-D24A-C; BWR-12/725-D24A-C; BWR-15/575-D12A-C; BWR-15/575-D24A-C**

**PART NUMBER STRUCTURE**

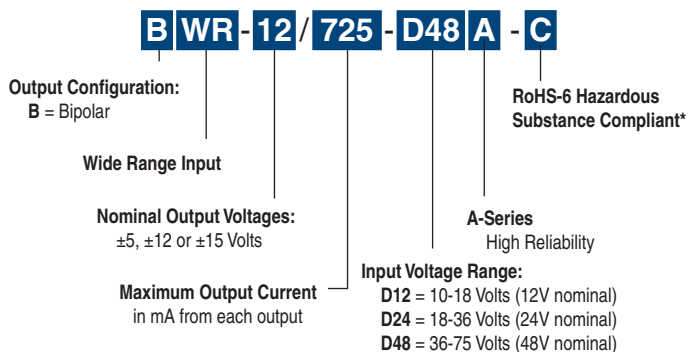

**Part Number Suffixes**

BWR 15-17 Watt DC/DC's are designed so an On/Off Control function with either positive polarity ("C" suffix) or negative polarity ("N" suffix) can be added to the pin 3 position. Models ordered without On/Off control (without C or N suffix) will not have pin 3 installed.

- No Suffix** Pin 3 not installed
- C** Positive On/Off control function (pin 3)
- N** Negative On/Off control function (pin 3)

\* Contact Murata Power Solutions for availability.

Some model number combinations may not be available. Please contact Murata Power Solutions for more information.

**MECHANICAL SPECIFICATIONS**

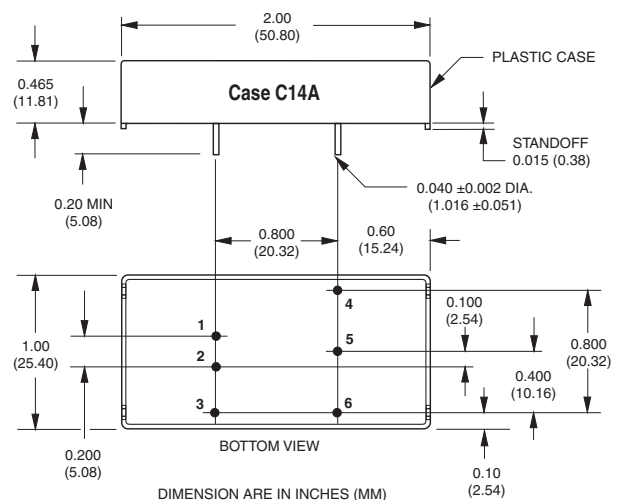

**I/O Connections**

Pin	Function P43
1	+Input
2	-Input
3	On/Off Control*
4	+Output
5	Output Return
6	-Output

\* Pin is optional

Dimensions are in inches (mm) shown for ref. only.

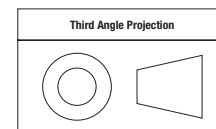

Tolerances (unless otherwise specified):  
 .XX ± 0.02 (0.5)  
 .XXX ± 0.010 (0.25)  
 Angles ± 2°

Components are shown for reference only.

## 15-17W, Dual Output DC/DC Converters

### Performance/Functional Specifications

Typical @ T<sub>A</sub> = +25°C under nominal line voltage and full-load conditions, unless noted. ①

Input	
<b>Input Voltage Range:</b>	
D12A Models	10-18 Volts (12V nominal)
D24A Models	18-36 Volts (24V nominal)
D48A Models	36-75 Volts (48V nominal)
<b>Overvoltage Shutdown:</b>	
D12A Models	19-21 Volts
D24A Models	37-40 Volts
D48A Models	77-81 Volts
<b>Start-Up Threshold:</b> ③	
D12A Models	9.4-10 Volts
D24A Models	16.5-18 Volts
D48A Models	34-36 Volts
<b>Undervoltage Shutdown:</b> ③	
D12A Models	7-8.5 Volts
D24A Models	15.5-17.5 Volts
D48A Models	32.5-34.5 Volts
<b>Input Current</b>	
Normal Operating Conditions	See Ordering Guide
Standby Mode (Off, OV, UV)	5mA
<b>Input Reflected Ripple Current</b> ⑥	10 mAp-p
<b>Input Filter Type</b>	Pi
<b>Reverse-Polarity Protection</b>	Brief duration, 5A maximum.
<b>On/Off Control:</b> ④ ⑤	
C Models	On = open or 13V- +VIN, I <sub>IN</sub> = 1mA max. Off = 0-0.8V, I <sub>IN</sub> = 1mA max.
N Models	On = 0-0.5V, I <sub>IN</sub> = 3mA max. Off = open or 3.5- +VIN, I <sub>IN</sub> = 1mA max.
Output	
<b>V<sub>OUT</sub> Accuracy</b> (balanced half load)	±2.0%, maximum
<b>Minimum Load Requirement</b> ②	10%
<b>Ripple/Noise</b> (20MHz BW) ① ⑥	See Ordering Guide
<b>Line/Load Regulation</b>	See Ordering Guide
<b>Efficiency</b>	See Ordering Guide
<b>Isolation Voltage</b>	1500Vdc, minimum
<b>Isolation Capacitance</b>	550pF
<b>Isolation Resistance</b>	10MΩ
<b>Current Limit Inception</b> (@ 98% V <sub>OUT</sub> )	
±5V Models	1.9-2.5A
±12V Models	1-1.5A
±15V Models	0.85-1.2A
<b>Short-Circuit Current</b>	
±5V Models	800mA maximum
±12V Models	700mA maximum
±15V Models	700mA maximum
<b>Overvoltage protection</b>	Output voltage comparator
±5V Models	5.45-7.15 Volts
±12V Models	13-15.8 Volts
±15V Models	16.2-19.8 Volts
<b>Maximum Capacitive Loading</b>	1000μF (per output)
<b>Temperature Coefficient</b>	±0.02% per °C

### Dynamic Characteristics

<b>Transient Response:</b> (50-100% load step to 2% V <sub>OUT</sub> )	250μsec maximum
<b>Start-Up Time:</b>	
V <sub>IN</sub> to V <sub>OUT</sub>	35msec
On/Off to V <sub>OUT</sub>	30msec
<b>Switching Frequency</b>	300kHz (±30kHz)
Environmental	
<b>MTBF</b>	Bellcore, ground fixed, fullpower 25°C ambient, 1 million hours
<b>Operating Temperature</b> (ambient): -40 to +85°C with derated power (see derating curves)	
<b>Thermal Shutdown</b>	115°C
<b>Storage Temperature</b>	-40 to +120°C
<b>Flammability</b>	UL 94V-0
Physical	
<b>Dimensions</b>	1" x 2" x 0.48" (25.4 x 50.8 x 12.19mm)
<b>Case Material</b>	Diallyl Phthalate
<b>Pin Material</b>	Gold-plate over copper alloy
<b>Weight</b>	1.19 ounces (34 grams)
<b>Primary to Secondary Insulation Level</b>	Functional

- ① All models are specified with no external I/O capacitors.
- ② See Technical Notes/Graphs for details.
- ③ Applying a voltage to the On/Off Control (pin 3) when no input power is applied to the converter can cause permanent damage to the converter.
- ④ Output noise may be further reduced with the addition of additional external output capacitors. See Technical Notes.
- ⑤ The On/Off Control is designed to be driven with open-collector logic or the application of appropriate voltage levels. Voltages may be referenced to the -Input (pin 2).
- ⑥ Input Ripple Current is tested/specified over a 5-20MHz bandwidth with an external 33μF input capacitor and a simulated source impedance of 220μF and 12μH. See I/O Filtering, Input Ripple Current and Output Noise for details.

### Absolute Maximum Ratings

<b>Input Voltage:</b>	
Continuous:	
D12A Models	23 Volts
D24A Models	42 Volts
D48A Models	81 Volts
Transient (100msec):	
D12A Models	50 Volts
D24A Models	50 Volts
D48A Models	100 Volts
<b>On/Off Control (pin 3) Max. Voltages</b>	
Referenced to -Input (pin 2)	
"C" Suffix	+VIN (+18 Volts)
"N" Suffix	+7 Volts
<b>Input Reverse-Polarity Protection</b>	Current must be <5 Amps. Brief duration only. Fusing recommended.
<b>Output Current</b>	Current limited. Devices can withstand sustained output short circuits without damage.
<b>Case Temperature</b>	120°C
<b>Storage Temperature</b>	-40 to +120°C
<b>Lead Temperature</b>	See soldering guidelines

These are stress ratings. Exposure of devices to greater than any of these conditions may adversely affect long-term reliability. Proper operation under conditions other than those listed in the Performance/Functional Specifications Table is not implied.

**TECHNICAL NOTES**

**Input Fusing**

Certain applications and/or safety agencies may require the installation of fuses at the inputs of power conversion components. Fuses should also be used if the possibility of sustained, non-current-limited, input-voltage polarity reversal exists. For MPS BWR 15-17 Watt DC/DC Converters, you should use slow-blow type fuses with values no greater than the following:

Model	Fuse Value
All D12A Models	4 Amp
BWR-5/1500-D24A	2 Amp
BWR-12/725-D24A, BWR-15/575-D24A	2.5 Amp
All D48A Models	1 Amp

**Start-Up Time**

The  $V_{IN}$  to  $V_{OUT}$  start-up time is the interval of time where the input voltage crosses the turn-on threshold point, and the fully loaded output voltage enters and remains within its specified accuracy band. Actual measured times will vary with external output capacitance and load. The BWR 15-17W Series implements a soft start circuit that limits the duty cycle of the PWM controller at power up, thereby limiting the Input Inrush current.

The On/Off Control to  $V_{OUT}$  start-up time assumes the converter has its nominal input voltage applied but is turned off via the On/Off Control pin. The specification defines the interval between the time at which the converter is turned on and the fully loaded output voltage enters and remains within its specified accuracy band. Similar to the  $V_{IN}$  to  $V_{OUT}$  start-up, the On/Off Control to  $V_{OUT}$  start-up time is also governed by the internal soft start circuitry and external load capacitance.

**Input Overvoltage/Undervoltage Shutdown and Start-Up Threshold**

Under normal start-up conditions, devices will not begin to regulate until the ramping-up input voltage exceeds the Start-Up Threshold Voltage (35V for D48 models). Once operating, devices will not turn off until the input voltage drops below the Undervoltage Shutdown limit (33.5V for D48 models). Subsequent re-start will not occur until the input is brought back up to the Start-Up Threshold. This built in hysteresis prevents any unstable on/off situations from occurring at a single input voltage.

Input voltages exceeding the input overvoltage shutdown specification listed in the Performance/Functional Specifications will cause the device to shutdown. A built-in hysteresis of 0.6 to 1.6 Volts for all models will not allow the converter to restart until the input voltage is sufficiently reduced.

**Input Source Impedance**

The converters must be driven from a low ac-impedance input source. The DC/DC's performance and stability can be compromised by the use of highly inductive source impedances. The input circuit shown in Figure 2 is a practical solution that can be used to minimize the effects of inductance in the input traces. For optimum performance, components should be mounted close to the DC/DC converter. If the application has a high source impedance, low  $V_{IN}$  models can benefit of increased external input capacitance.

**I/O Filtering, Input Ripple Current, and Noise Reduction**

All BWR 15-17W DC/DC Converters achieve their rated ripple and noise specifications without the use of external input/output capacitors. In critical applications, input/output ripple and noise may be further reduced by installing additional external I/O caps.

External input capacitors ( $C_{IN}$  in Figure 2) serve primarily as energy-storage elements, minimizing line voltage variations caused by transient IR drops in conductors from backplane to the DC/DC. Input caps should be selected for bulk capacitance (at appropriate frequencies), low ESR, and high rms-ripple-current ratings. The switching nature of DC/DC converters requires that dc voltage sources have low ac impedance as highly inductive source impedance can affect system stability. In Figure 2,  $C_{BUS}$  and  $L_{BUS}$  simulate a typical dc voltage bus. Your specific system configuration may necessitate additional considerations.

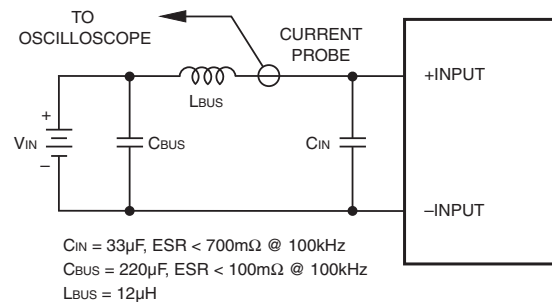

**Figure 2. Measuring Input Ripple Current**

In critical applications, output ripple/noise (also referred to as periodic and random deviations or PARD) may be reduced below specified limits using filtering techniques, the simplest of which is the installation of additional external output capacitors. These output caps function as true filter elements and should be selected for bulk capacitance, low ESR and appropriate frequency response. All external capacitors should have appropriate voltage ratings and be located as close to the converter as possible. Temperature variations for all relevant parameters should also be taken carefully into consideration. The most effective combination of external I/O capacitors will be a function of line voltage and source impedance, as well as particular load and layout conditions.

**Floating Outputs**

Since these are isolated DC/DC converters, their outputs are "floating," with respect to the input. As such, it is possible to use +Output, -Output or Output Return as the system ground thereby allowing the flexibility to generate a variety of output voltage combinations.

Regulation for BWR 15-17W bipolar converters is monitored between -Output and +Output (as opposed to Output to Return).

**Minimum Loading Requirements**

BWR 15-17W converters employ a classical diode-rectification design topology and require a minimum 10% loading to achieve their listed regulation specifications and a stable operating condition.

**Load Regulation**

Regulation for the BWR 15-17W bipolar converters is monitored between -Output and +Output (as opposed to Output to Return). As such regulation will assure that voltage between -Output and +Output pins remains within the  $V_{OUT}$  accuracy listed in the Performance/Functional Specifications table.

If loading from +/- Outputs to Output Return is symmetrical, the voltage at Output pins with respect to Output Return will also be symmetrical. An unbalance in loading will consequently result in a degraded  $V_{OUT}$  regulation accuracy from +/- Outputs to Output Return (-Output to +Output regulation will still be within specification) with a load step from minimum to maximum load and with the other output at full load, the maximum deviation is 2.5%  $V_{OUT}$  nominal.

**BWR-15/575-D48A Unbalanced Output Load Regulation**

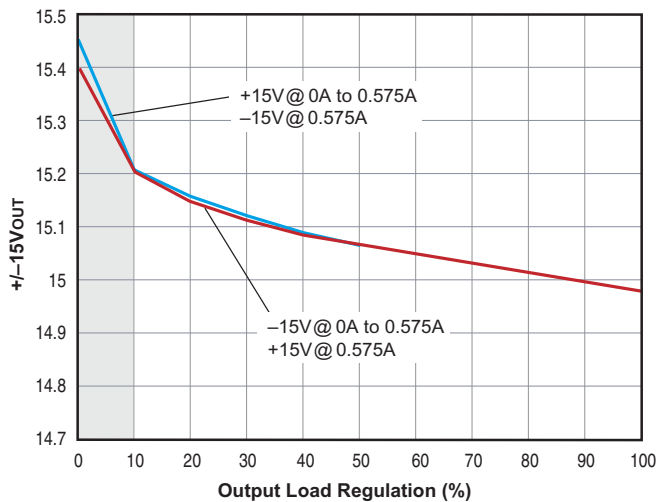

**Figure 4. Output Voltage Accuracy vs. Imbalanced Loading**

**Current Limiting**

When output current increases to approximately 15% to 50% above the rated output current, the DC/DC converter will go into a current limiting mode. In this condition the output voltage will decrease proportionately with increases in output current, thereby maintaining a somewhat constant power dissipation. This is commonly referred to as power limiting. Current limit inception is defined as the point where the full-power output voltage falls below the specified tolerance. See Performance/Functional Specifications. If the load current being drawn from the converter is significant enough, the unit will go into a short circuit condition. See "Short Circuit Condition."

**Short Circuit Condition**

When a converter is in current limit mode the output voltages will drop as the output current demand increases. If the output voltage drops too low, the magnetically coupled voltage used to develop primary side voltages will also drop, thereby shutting down the PWM controller.

Following a time-out period, the PWM will restart, causing the output voltages to begin ramping to their appropriate values. If the short-circuit condition persists, another shutdown cycle will be initiated. This on/off cycling is referred to as "hiccup" mode. The hiccup cycling reduces the average output current, thereby preventing internal temperatures from rising to excessive levels. The BWR 15-17W Series is capable of enduring an indefinite short circuit output condition.

**Thermal Shutdown**

These BWR converters are equipped with Thermal Shutdown Circuitry. If environmental conditions cause the internal temperature of the DC/DC converter rises above the designed operating temperature, a precision temperature sensor will power down the unit. When the internal temperature decreases below the threshold of the temperature sensor the unit will self start.

**Start-Up Time**

The  $V_{IN}$  to  $V_{OUT}$  start-up time is the interval of time where the input voltage crosses the turn-on threshold point, and the fully loaded output voltage enters and remains within its specified accuracy band. Actual measured times will vary with external output capacitance and load. The BWR 15-17W Series implements a soft start circuit that limits the duty cycle of the PWM controller at power up, thereby limiting the Input Inrush current.

The On/Off Control to  $V_{OUT}$  start-up time assumes the converter has its nominal input voltage applied but is turned off via the On/Off Control pin. The specification defines the interval between the time at which the converter is turned on and the fully loaded output voltage enters and remains within its specified accuracy band. Similar to the  $V_{IN}$  to  $V_{OUT}$  start-up, the On/Off Control to  $V_{OUT}$  start-up time is also governed by the internal soft start circuitry and external load capacitance.

**On/Off Control**

The input-side, remote On/Off Control function (pin 3) can be ordered to operate with either polarity. Positive-polarity devices ("C" suffix) are enabled when pin 3 is left open (or is pulled high, +13V to  $V_{IN}$  applied with respect to -Input, pin 2, see Figure 2). Positive-polarity devices are disabled when pin 3 is pulled low (0-0.8V with respect to -Input). Negative-polarity devices are off when pin 3 is left open (or pulled high, 3.5V to  $V_{IN}$ ), and on when pin 3 is pulled low (0-0.5V). See Figure 5.

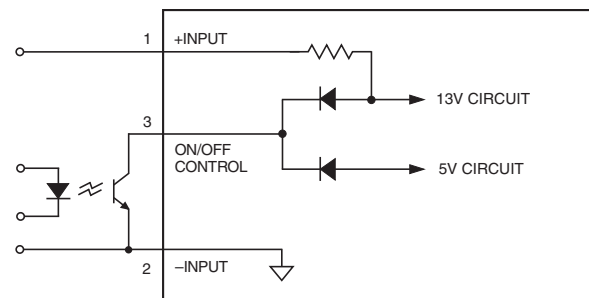

**Figure 4. Driving the Positive Polarity On/Off Control Pin**

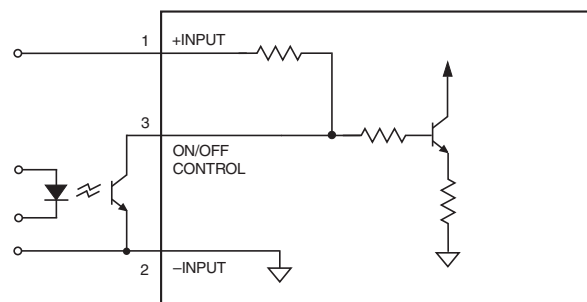

**Figure 5. Driving the Negative Polarity On/Off Control Pin**

Dynamic control of the remote on/off function is best accomplished with a mechanical relay or an open-collector/open-drain drive circuit (optically isolated if appropriate). The drive circuit should be able to sink appropriate current (see Performance Specs) when activated and withstand appropriate voltage when deactivated.

Applying an external voltage to pin 3 when no input power is applied to the converter can cause permanent damage to the converter.

**Typical Performance Curves**

**BWR-5/1500-D12A Efficiency vs. Input Line And Output Load**

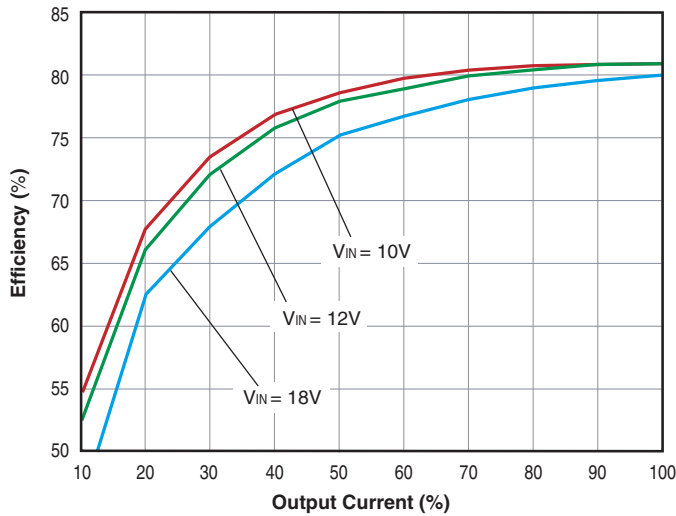

**BWR-5/1500-D12A Output Power vs. Ambient Temperature (No air flow)**

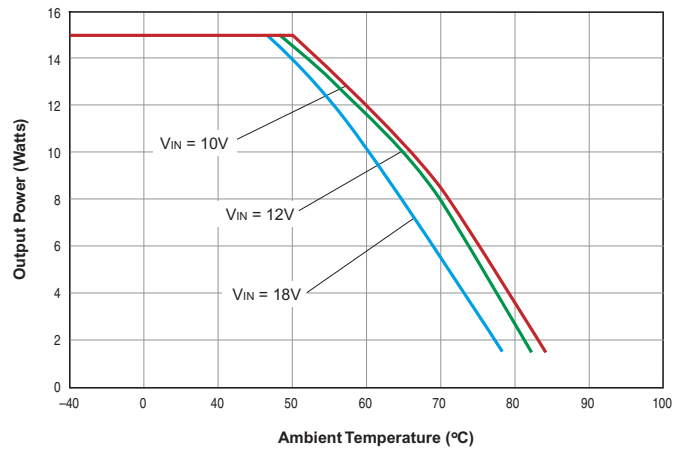

**BWR-5/1500-D24A Efficiency vs. Input Line And Output Load**

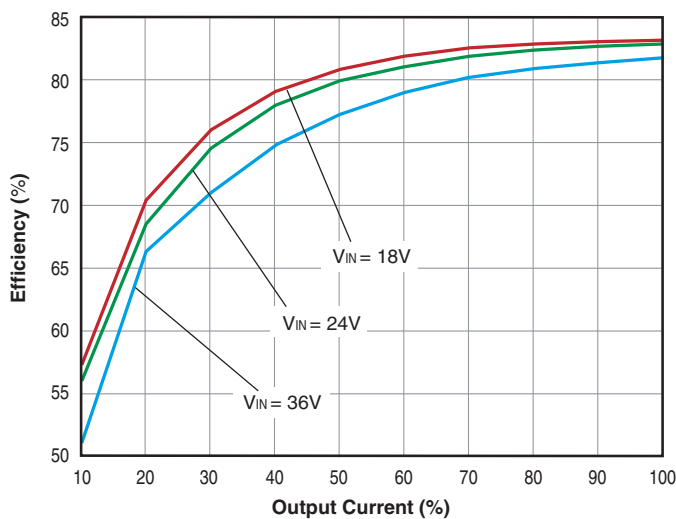

**BWR-5/1500-D24A Output Power vs. Ambient Temperature (No air flow)**

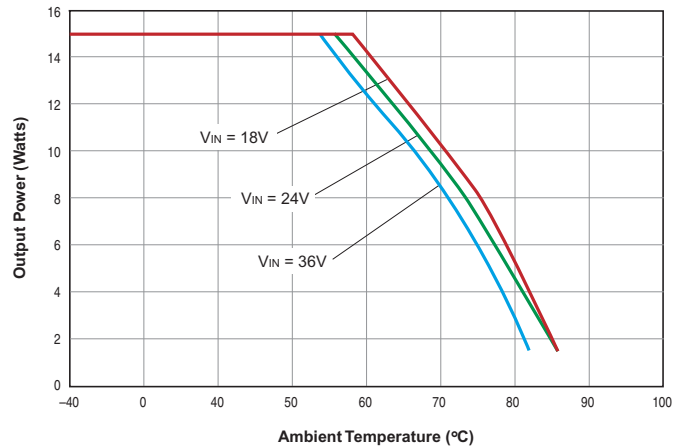

**BWR-5/1500-D48A Efficiency vs. Input Line And Output Load**

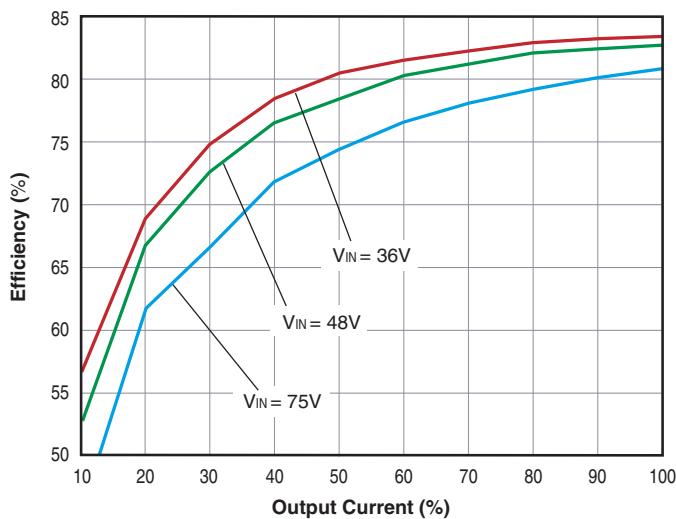

**BWR-5/1500-D48A Output Power vs. Ambient Temperature (No air flow)**

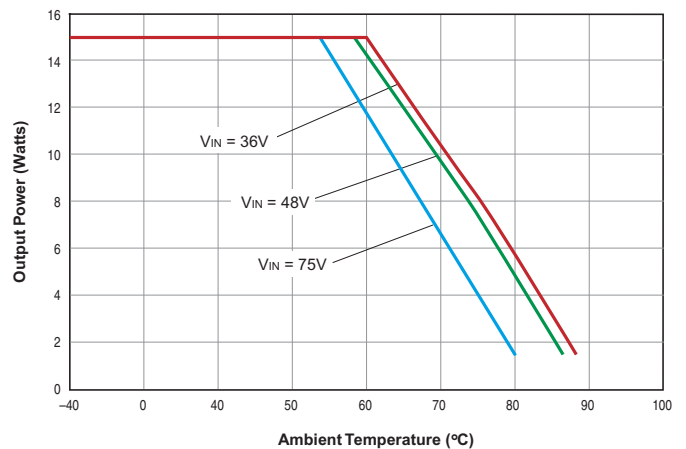

**Typical Performance Curves**

**BWR-12/725-D12A Efficiency vs. Input Line And Output Load**

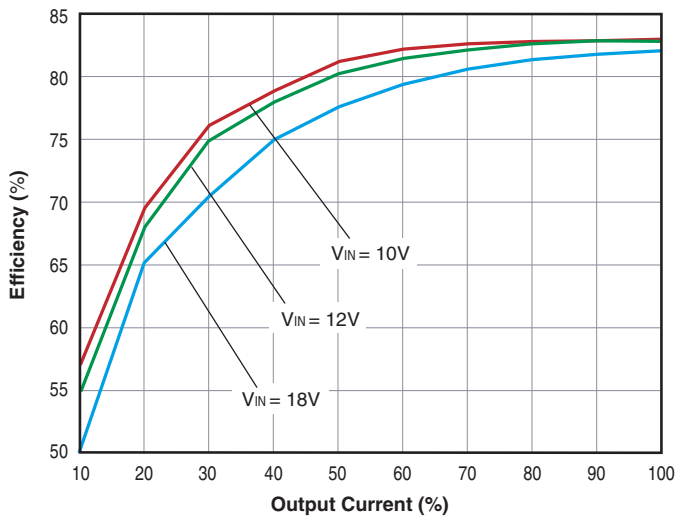

**BWR-12/725-D12A Output Power vs. Ambient Temperature (No air flow)**

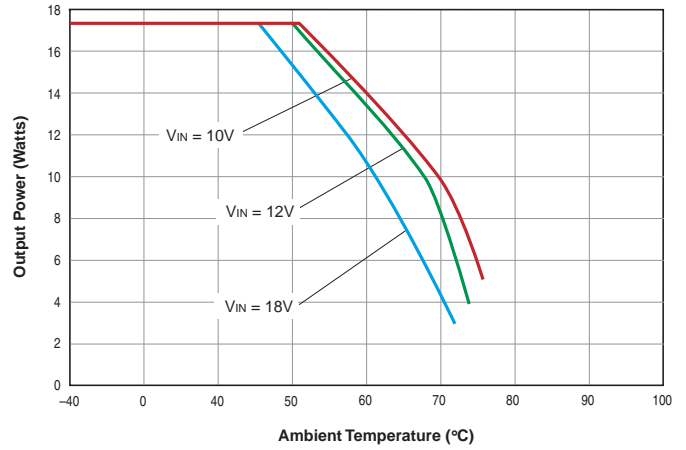

**BWR-12/725-D24A Efficiency vs. Input Line And Output Load**

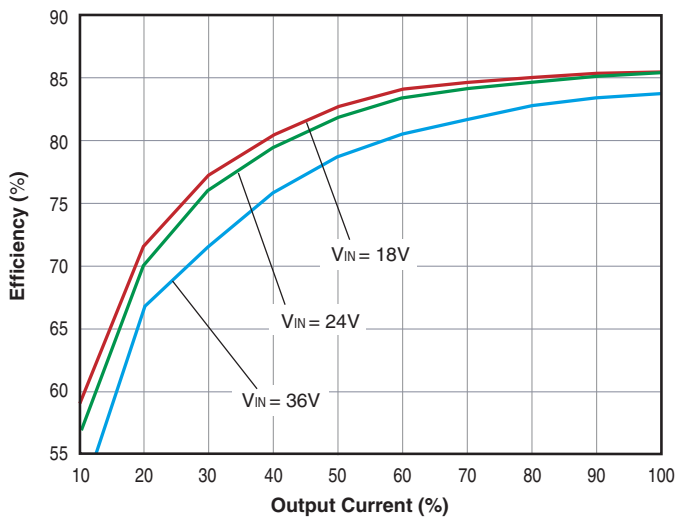

**BWR-12/725-D24A Output Power vs. Ambient Temperature (No air flow)**

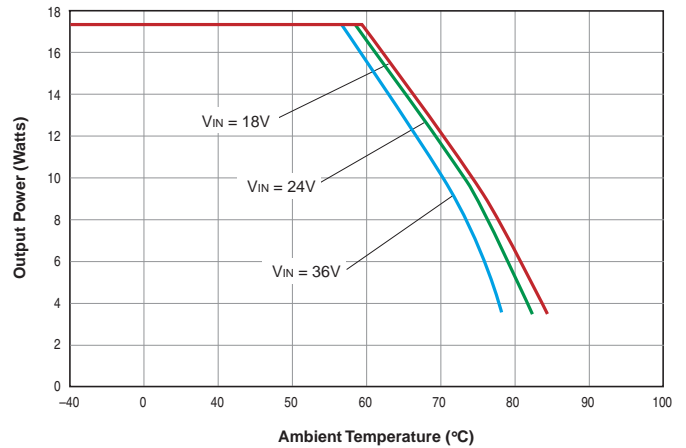

**BWR-12/725-D48A Efficiency vs. Input Line And Output Load**

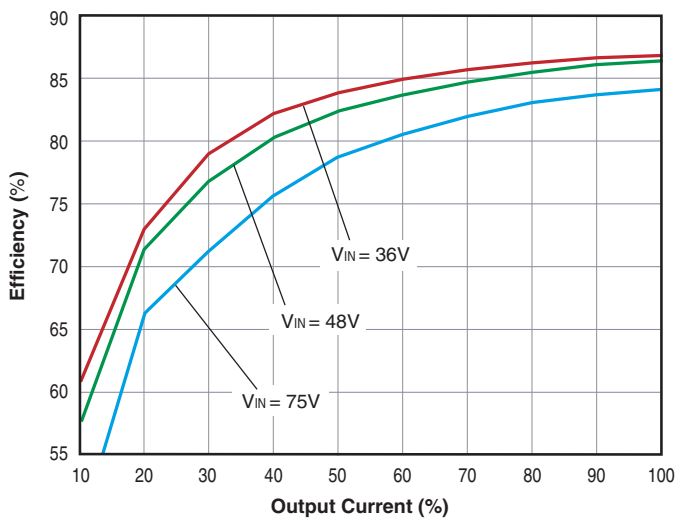

**BWR-12/725-D48A Output Power vs. Ambient Temperature (Air flow from Input or Output)**

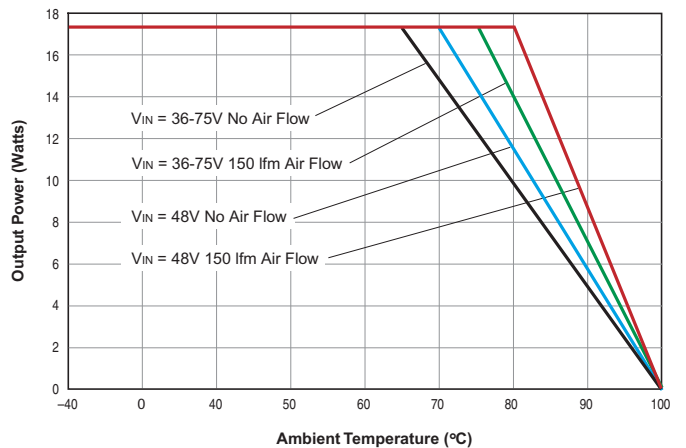

**Typical Performance Curves**

**BWR-15/575-D12A Efficiency vs. Input Line And Output Load**

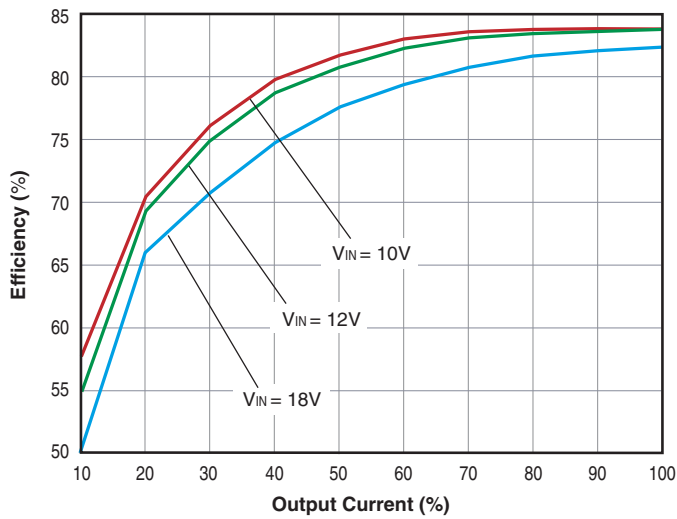

**BWR-15/575-D12A Output Power vs. Ambient Temperature (No air flow)**

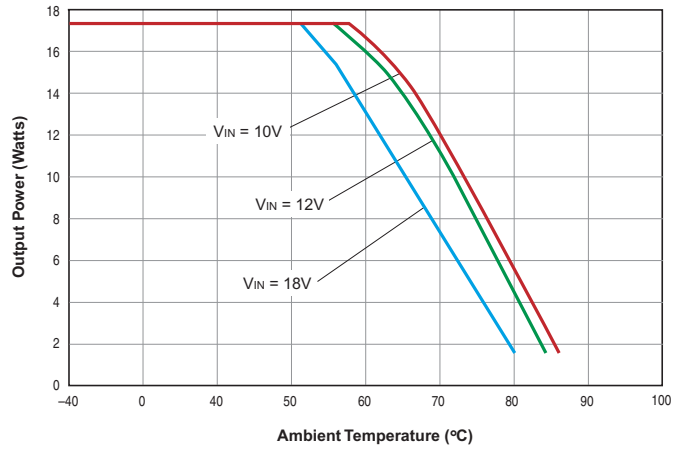

**BWR-15/575-D24A Efficiency vs. Input Line And Output Load**

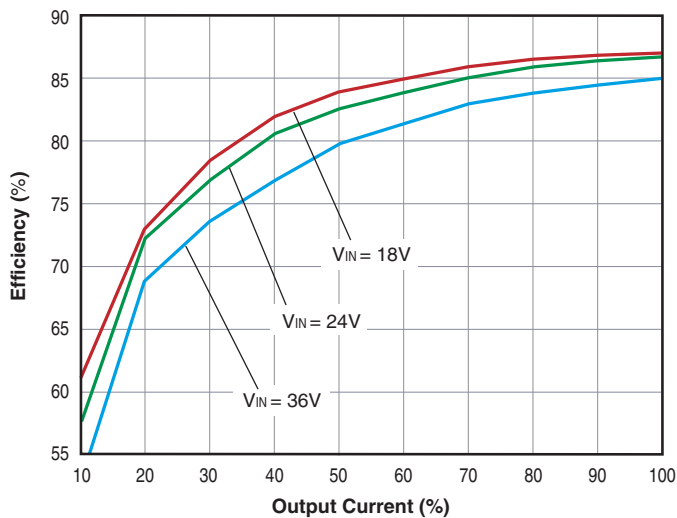

**BWR-15/575-D24A Output Power vs. Ambient Temperature (No air flow)**

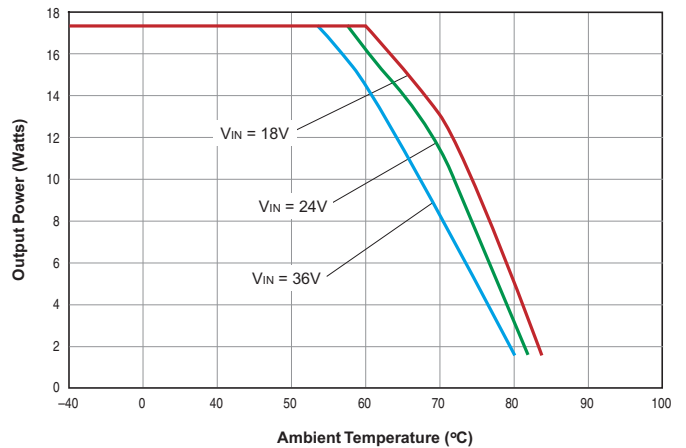

**BWR-15/575-D48A Efficiency vs. Input Line And Output Load**

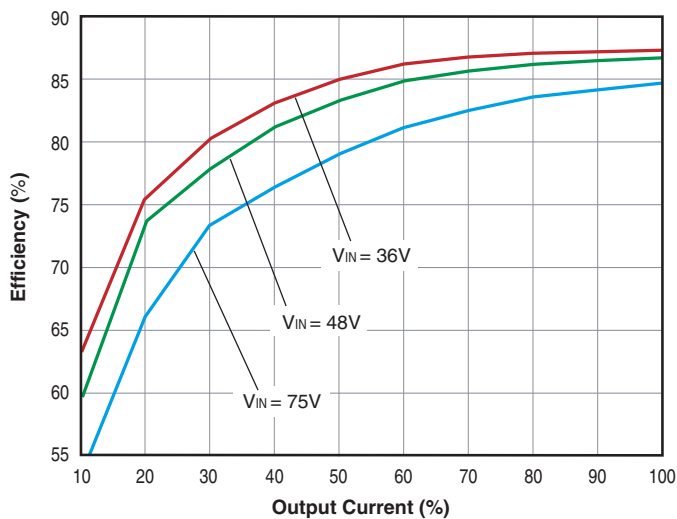

**BWR-15/575-D48A Output Power vs. Ambient Temperature (No air flow)**

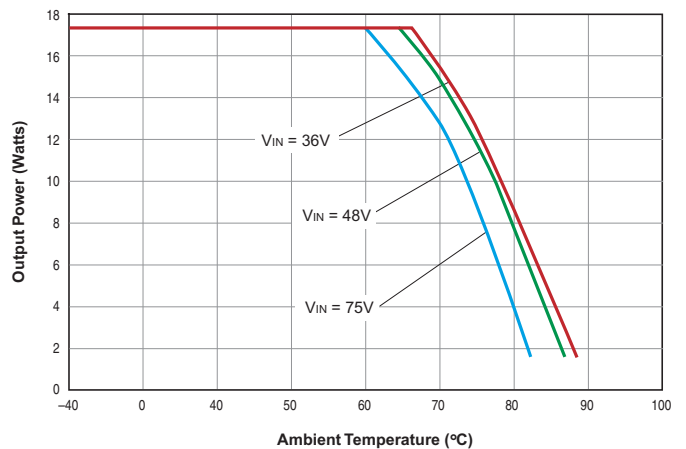

**Typical Performance Curves**

**Start-Up from VIN to VOUT**  
(VIN = 48V to Full Load)

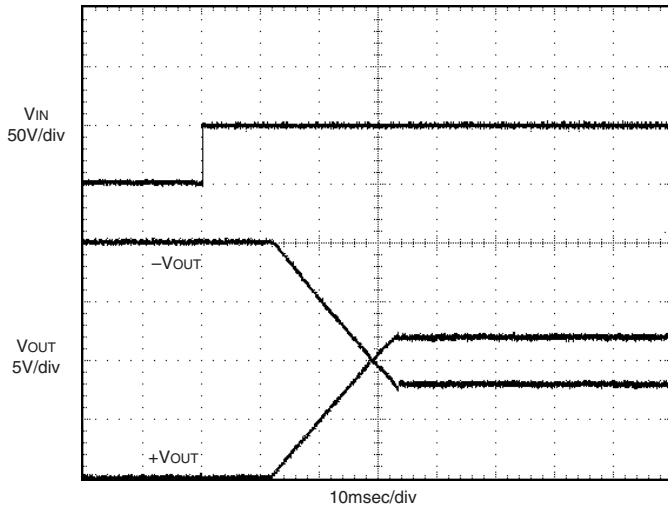

**Start-Up from On/Off to VOUT**  
(VIN = 48V to Full Load)

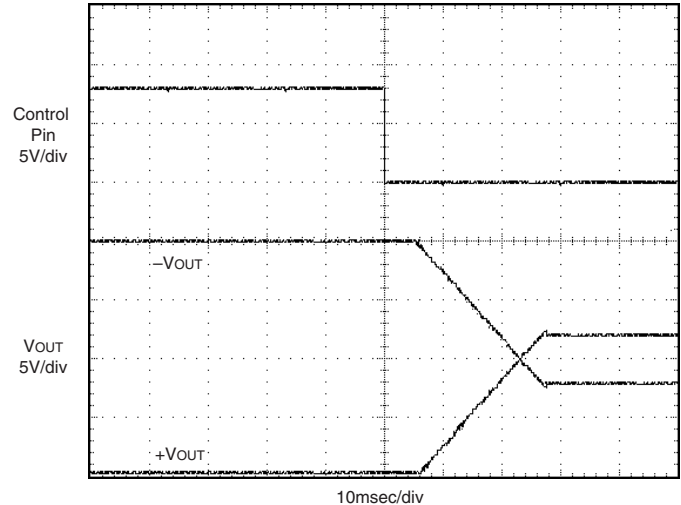

**Adaptations**

Several different additional converter configurations are available. Generally, these are modifications of an existing standard product. In some cases, they are designated with an additional 5-digit suffix on the end of the root parent standard model number. The actual details of the modification are contained in a Specification Control Drawing maintained by MPS and tracked using this same 5-digit special number suffix. These adapted products are normally built in the same production facilities and to the same quality standards as catalog products. Usually, they share the same components.

Once a modified product has been configured and supplied to a customer, it may be available as a "standard" product to other customers, assuming there is no proprietary status or other restriction. There may be scheduling and minimum order requirements for such products. Contact Murata Power Solutions directly if you are interested in your own set of adaptations or modifications.

**Soldering Guidelines**

Murata Power Solutions recommends the specifications below when installing these converters. These specifications vary depending on the solder type. Exceeding these specifications may cause damage to the product. Be cautious when there is high atmospheric humidity. We strongly recommend a mild pre-bake (100° C. for 30 minutes). Your production environment may differ; therefore please thoroughly review these guidelines with your process engineers.

**Wave Solder Operations for through-hole mounted products (THMT)**

**For Sn/Ag/Cu based solders:**

Maximum Preheat Temperature	115° C.
Maximum Pot Temperature	270° C.
Maximum Solder Dwell Time	7 seconds

**For Sn/Pb based solders:**

Maximum Preheat Temperature	105° C.
Maximum Pot Temperature	250° C.
Maximum Solder Dwell Time	6 seconds

Murata Power Solutions, Inc.  
11 Cabot Boulevard, Mansfield, MA 02048-1151 U.S.A.  
ISO 9001 and 14001 REGISTERED



**This product is subject to the following operating requirements and the Life and Safety Critical Application Sales Policy:**  
Refer to: <http://www.murata-ps.com/requirements/>

Murata Power Solutions, Inc. makes no representation that the use of its products in the circuits described herein, or the use of other technical information contained herein, will not infringe upon existing or future patent rights. The descriptions contained herein do not imply the granting of licenses to make, use, or sell equipment constructed in accordance therewith. Specifications are subject to change without notice. © 2014 Murata Power Solutions, Inc.