

Product Information



3478UAR200P63 red

EAN 4031582306873

Fixed castor, Fork made of pressed steel, bright zinc plated, blue passivated, wheel axle with nut, plate fitting.

Wheel centre made of Polyamide, Tread: Polyurethane, roller bearing

Technical Data	
Wheel diameter	200 mm
Width of Tread	46 mm
Size of Plate	137 x 115 mm
Plate hole centres	105 x 80/75 mm
Plate hole	11 mm
Overall height	240 mm
Temperature	- 40 / + 80 °C
Standard	EN 12532
Weight	2.08 kg
Hardness of tread	D 60 Shore
Load capacity	350 kg
Load capacity (static)	700 kg

Roll performance	+	+	+	+	+
Movement noise	+	+	+	+	+
Attrition	+	+	+	+	+
Corrosion resistance	+	+	+	+	+

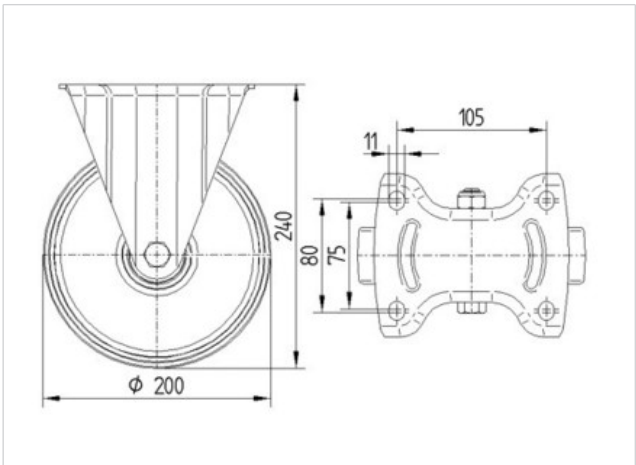



3478UAR200P63 red

EAN 4031582306873

