

Notice for TAIYO YUDEN products

Please read this notice before using the TAIYO YUDEN products.



REMINDERS

- Product information in this catalog is as of October 2008. All of the contents specified herein are subject to change without notice due to technical improvements, etc. Therefore, please check for the latest information carefully before practical application or usage of the Products.

Please note that Taiyo Yuden Co., Ltd. shall not be responsible for any defects in products or equipment incorporating such products, which are caused under the conditions other than those specified in this catalog or individual specification.

- Please contact Taiyo Yuden Co., Ltd. for further details of product specifications as the individual specification is available.
- Please conduct validation and verification of products in actual condition of mounting and operating environment before commercial shipment of the equipment.
- All electronic components or functional modules listed in this catalog are developed, designed and intended for use in general electronics equipment.(for AV, office automation, household, office supply, information service, telecommunications, (such as mobile phone or PC) etc.). Before incorporating the components or devices into any equipment in the field such as transportation,(automotive control, train control, ship control), transportation signal, disaster prevention, medical, public information network (telephone exchange, base station) etc. which may have direct influence to harm or injure a human body, please contact Taiyo Yuden Co., Ltd. for more detail in advance.

Do not incorporate the products into any equipment in fields such as aerospace, aviation, nuclear control, submarine system, military, etc. where higher safety and reliability are especially required.

In addition, even electronic components or functional modules that are used for the general electronic equipment, if the equipment or the electric circuit require high safety or reliability function or performances, a sufficient reliability evaluation check for safety shall be performed before commercial shipment and moreover, due consideration to install a protective circuit is strongly recommended at customer's design stage.

- The contents of this catalog are applicable to the products which are purchased from our sales offices or distributors (so called "TAIYO YUDEN' s official sales channel"). It is only applicable to the products purchased from any of TAIYO YUDEN' s official sales channel.
- Please note that Taiyo Yuden Co., Ltd. shall have no responsibility for any controversies or disputes that may occur in connection with a third party's intellectual property rights and other related rights arising from your usage of products in this catalog. Taiyo Yuden Co., Ltd. grants no license for such rights.
- Caution for export
Certain items in this catalog may require specific procedures for export according to "Foreign Exchange and Foreign Trade Control Law" of Japan, "U.S. Export Administration Regulations," and other applicable regulations. Should you have any question or inquiry on this matter, please contact our sales staff.
Should you have any question or inquiry on this matter, please contact our sales staff.

巻線チップインダクタ

WOUND CHIP INDUCTORS

LB SERIES

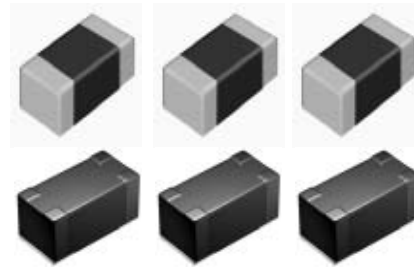

リフロー/REFLOW

OPERATING TEMP.	-25~+105°C (製品自己発熱含む) (Including self-generated heat)
-----------------	--

特長 FEATURES

豊富なラインアップ形状と標準、低Rdc、大電流シリーズでお客様の広範囲な回路設計に対応する、巻線チップインダクタです。

- ・LB/LBRシリーズ：超低Rdc特性で且つ高I_{dc}特性です。
- ・LBCシリーズ：超高I_{dc}特性で且つ低Rdc特性です。
- ・LB3218シリーズ：3225サイズからのダウンサイジング対応品です。
ランドパターンは3225サイズのままでご使用できます。
- ・LBMF1608
下面電極構造採用により、最大効率設計を実現。1608形状により高密度実装が可能となります。

Wound Chip Inductors that cover customers' wide range module design by wide-line-up shape, standard, low Rdc, and high electric current series.

- ・LB/LBR Series
Super low Rdc and high I_{dc} characteristics.
- ・LBC Series
Super high I_{dc} and low Rdc characteristics.
- ・LB3218 Series
This series are down sized from 3225 size. Land pattern can be used by 3225 size.
- ・LBMF1608 Series
The best efficiency design is achieved by adopting bottom-surface electrode structure. Because of 1608 shape, it can be high-density mount.

用途 APPLICATIONS

・DSC / DVC / HDD、液晶、携帯電話、ゲーム機器、各種映像機器、各種通信機器など

・DSC/DVC/HDD, LCD, portable telephones, game equipments, Various audio-visual equipments, various communication equipments, etc.

形名表記法 ORDERING CODE

1 形式 LB 巻線チップインダクタ	3 外形寸法 [mm] 1608 (0603) 1.6×0.8 2012 (0805) 2.0×1.25 2016 (0806) 2.0×1.6 2518 (1007) 2.5×1.8 3218 (1207) 3.2×1.8	5 公称インダクタンス [μH] 例 1R0 1 100 10 101 100 ※R=小数点	6 インダクタンス許容差 [%] K ±10 M ±20
2 特性仕様 △ 標準品 C 大電流 R 低Rdc MF 下面電極	4 包装 T テーピング	7 個別仕様 △ 標準品 R 低Rdc品	8 当社管理記号 △△△ 標準品 △=スペース



1 Type LB Wound chip inductor	3 External Dimensions [mm] 1608 (0603) 1.6×0.8 2012 (0805) 2.0×1.25 2016 (0806) 2.0×1.6 2518 (1007) 2.5×1.8 3218 (1207) 3.2×1.8	5 Nominal Inductance [μH] example 1R0 1 100 10 101 100 *R=decimal point	6 Inductance Tolerances [%] K ±10 M ±20
2 Shape △ Standard products C High current R Low Rdc MF Bottom-surface electrode	4 Packaging T Tape & Reel	7 Special code △ Standard products R Low Rdc type	8 Internal code △△△ Standard Products △ = Blank space

外形寸法 EXTERNAL DIMENSIONS

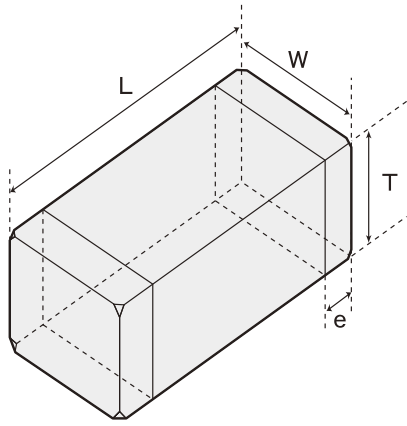

Type	L	W	T	e
LB3218	3.2±0.2 (0.128±0.008)	1.8±0.2 (0.072±0.008)	1.8±0.2 (0.072±0.008)	0.6±0.2 (0.024±0.008)
LB2518 / LBC2518 / LBR2518	2.5±0.2 (0.098±0.008)	1.8±0.2 (0.071±0.008)	1.8±0.2 (0.071±0.008)	0.5±0.2 (0.020±0.008)
LB2016 / LBC2016	2.0±0.2 (0.079±0.008)	1.6±0.2 (0.063±0.008)	1.6±0.2 (0.063±0.008)	0.5±0.2 (0.020±0.008)
LB2012 / LBC2012 / LBR2012	2.0±0.2 (0.079±0.008)	1.25±0.2 (0.049±0.008)	1.25±0.2 (0.049±0.008)	0.5±0.2 (0.020±0.008)
LB1608	1.6±0.1 (0.063±0.004)	0.8±0.1 (0.031±0.004)	0.8±0.1 (0.031±0.004)	0.35±0.15 (0.014±0.006)
LBMF1608	1.6±0.2 (0.063±0.008)	0.8±0.2 (0.031±0.008)	0.8±0.2 (0.031±0.008)	0.45±0.15 (0.016±0.006)

推奨ランドパターン Recommended Land Patterns

実装上の注意

- ・実装状態を確認の上ご使用下さいませようお願いいたします。
- ・本製品のはんだ付けはリフローはんだ工法に限ります。
- ・推奨ランドパターン

Surface Mounting

- ・Mounting and soldering conditions should be checked beforehand.
- ・Applicable soldering process to this products is reflow soldering only.
- ・Recommended Land Patterns

Unit : mm (inch)

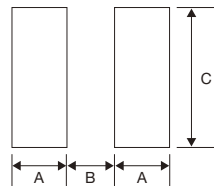

Unit : mm

TYPE	A	B	C
1608	0.55	0.7	1.0
MF1608	0.55	0.8	1.0
2012	0.7	0.8	1.45
2016	0.7	0.8	1.8
2518	0.8	1.2	2.0
3218	1.0	1.6	2.0

概略バリエーション AVAILABLE INDUCTANCE RANGE

Type	LB3218	LB2518	LB2016	LB2012	LB1608	LBC2518	LBC2016	LBC2012	LBR2518	LBR2012	LBMF1608
Inductance [μH]	1075 1μH 0.06 340 0.25 140 2.40 40 1000μH	665 1μH 0.06 165 0.25 60 2.1 15 1000μH	490 1μH 0.09 155 0.5 40 4.5 100μH	405 1μH 0.15 120 0.7 45 7.0 100μH	160 1μH 0.17 70 0.55 60 0.7 10μH	775 1μH 0.08 375 0.36 125 3.70 45 680μH	690 1μH 0.1 245 0.82 75 8.0 100μH	620 1μH 0.19 200 1.2 90 5.8 47μH	960 1μH 0.045 235 0.19 80 1.89 100μH	400 1μH 0.07 150 0.36 50 4.0 100μH	230 1μH 0.09 80 0.36 35 2.5 47μH

代表値 Examples	Inductance	Imax [mA]	Rdc±30% [Ω]	Imax [mA]	Rdc±30% [Ω]	Imax [mA]	Rdc±30% [Ω]	Imax [mA]	Rdc±30% [Ω]	Imax [mA]	Rdc±30% [Ω]	Imax [mA]	Rdc±30% [Ω]	Imax [mA]	Rdc±30% [Ω]	Imax [mA]	Rdc±30% [Ω]	Imax [mA]	Rdc±30% [Ω]	Imax [mA]	Rdc±30% [Ω]	
	1μH	1075	0.06	665	0.06	490	0.09	405	0.15	160	0.17	775	0.08	690	0.1	620	0.19	960	0.045	400	0.07	230
10μH	340	0.25	165	0.25	155	0.5	120	0.7	60	0.70	375	0.36	245	0.82	200	1.2	235	0.19	150	0.36	80	0.36
100μH	140	2.40	60	2.1	40	4.5	45	7.0	—	—	125	3.70	75	8.0	90(47μH)	5.8(47μH)	80	1.89	50	4.0	35(47μH)	2.5(47μH)
1000μH	40	27	15	24	—	—	—	—	—	—	—	—	—	—	—	—	—	—	—	—	—	—

セレクションガイド Selection Guide

アイテム一覧 Part Numbers

特性図 Electrical Characteristics

梱包 Packaging

信頼性 Reliability Data

使用上の注意 Precautions



etc

LB1608 TYPE

形名 Ordering code	EHS (Environmental Hazardous Substances)	公称 インダクタンス Inductance [μH]	インダクタンス 許容差 Inductance Tolerance	自己共振 周波数 Self-resonant frequency [MHz] min.	直流抵抗 DC Resistance [Ω] (±30%)	定格電流 Rated current [mA] max.	測定 周波数 Measuring frequency [MHz]
LB 1608T1R0M	RoHS	1.0	±20%	100	0.17	160	7.96
LB 1608T2R2M	RoHS	2.2		80	0.33	115	
LB 1608T4R7M	RoHS	4.7		45	0.55	70	
LB 1608T8R2M	RoHS	8.2		32	0.70	60	2.52
LB 1608T100M	RoHS	10		32	0.70	60	

LB2012 TYPE

形名 Ordering code	EHS (Environmental Hazardous Substances)	公称 インダクタンス Inductance [μH]	インダクタンス 許容差 Inductance Tolerance	自己共振 周波数 Self-resonant frequency [MHz] min.	直流抵抗 DC Resistance [Ω] (±30%)	定格電流 Rated current [mA] max.	測定 周波数 Measuring frequency [MHz]	
LB 2012T1R0M	RoHS	1.0	±20%	100	0.15	405	7.96	
LB 2012T2R2M	RoHS	2.2		80	0.23	260		
LB 2012T3R3M	RoHS	3.3		55	0.30	235		
LB 2012T4R7M	RoHS	4.7		45	0.40	190		
LB 2012T6R8M	RoHS	6.8		38	0.47	135		
LB 2012T100□	RoHS	10	±10% ±20%	32	0.70	120	2.52	
LB 2012T100□R	RoHS	10		32	0.50	120		
LB 2012T150□	RoHS	15		28	1.3	100		
LB 2012T220□	RoHS	22		16	1.7	80		
LB 2012T470□	RoHS	47		11	3.7	60		
LB 2012T680□	RoHS	68		10	6.0	50		
LB 2012T101□	RoHS	100		8	7.0	45		0.796

LB2016 TYPE

形名 Ordering code	EHS (Environmental Hazardous Substances)	公称 インダクタンス Inductance [μH]	インダクタンス 許容差 Inductance Tolerance	自己共振 周波数 Self-resonant frequency [MHz] min.	直流抵抗 DC Resistance [Ω] (±30%)	定格電流 Rated current [mA] max.	測定 周波数 Measuring frequency [MHz]
LB 2016T1R0M	RoHS	1.0	±20%	100	0.09	490	7.96
LB 2016T1R5M	RoHS	1.5		80	0.11	380	
LB 2016T2R2M	RoHS	2.2		70	0.13	375	
LB 2016T3R3M	RoHS	3.3		55	0.20	285	
LB 2016T4R7M	RoHS	4.7		45	0.25	225	
LB 2016T6R8M	RoHS	6.8	±10% ±20%	38	0.35	200	2.52
LB 2016T100□	RoHS	10		32	0.50	155	
LB 2016T150□	RoHS	15		28	0.70	130	
LB 2016T220□	RoHS	22		16	1.0	105	
LB 2016T330□	RoHS	33		14	1.7	85	
LB 2016T470□	RoHS	47		11	2.4	70	
LB 2016T680□	RoHS	68		10	3.0	55	
LB 2016T101□	RoHS	100		8	4.5	40	

LB2518 TYPE

形名 Ordering code	EHS (Environmental Hazardous Substances)	公称 インダクタンス Inductance [μH]	インダクタンス 許容差 Inductance Tolerance	自己共振 周波数 Self-resonant frequency [MHz] min.	直流抵抗 DC Resistance [Ω] (±30%)	定格電流 Rated current [mA] max.	測定 周波数 Measuring frequency [MHz]
LB 2518T1R0M	RoHS	1.0	±20%	100	0.06	665	7.96
LB 2518T1R5M	RoHS	1.5		80	0.07	405	
LB 2518T2R2M	RoHS	2.2		68	0.09	340	
LB 2518T3R3M	RoHS	3.3		54	0.11	280	
LB 2518T4R7M	RoHS	4.7		46	0.13	240	
LB 2518T4R7MR	RoHS	4.7	±10% ±20%	46	0.10	235	2.52
LB 2518T6R8M	RoHS	6.8		38	0.15	195	
LB 2518T100□	RoHS	10		30	0.25	165	
LB 2518T150□	RoHS	15		23	0.32	145	
LB 2518T220□	RoHS	22		19	0.50	115	
LB 2518T330□	RoHS	33		15	0.70	95	
LB 2518T470□	RoHS	47		12	0.95	85	
LB 2518T680□	RoHS	68		9.5	1.5	70	
LB 2518T101□	RoHS	100		9.0	2.1	60	
LB 2518T151□	RoHS	150		7.0	3.2	45	
LB 2518T221□	RoHS	220		5.5	4.5	40	
LB 2518T331□	RoHS	330		4.5	7.0	30	
LB 2518T471□	RoHS	470		3.5	10	25	
LB 2518T681□	RoHS	680		3.0	17	20	
LB 2518T102□	RoHS	1000		2.4	24	15	

(注) 形名の□にはインダクタンス許容差記号 (M または K) が入ります。

□ Please specify the Inductance tolerance code (K or M)

LB3218 TYPE

形名 Ordering code	EHS (Environmental Hazardous Substances)	公称 インダクタンス Inductance [μH]	インダクタンス 許容差 Inductance Tolerance	自己共振 周波数 Self-resonant frequency [MHz] min.	直流抵抗 DC Resistance [Ω] (±30%)	定格電流 Rated current [mA] max.	測定 周波数 Measuring frequency [MHz]
LB 3218T1R0M	RoHS	1.0	±20%	100	0.06	1075	7.96
LB 3218T1R5M	RoHS	1.5		80	0.07	860	
LB 3218T2R2M	RoHS	2.2		68	0.09	775	
LB 3218T3R3M	RoHS	3.3		54	0.11	560	
LB 3218T4R7M	RoHS	4.7		41	0.13	550	
LB 3218T6R8M	RoHS	6.8		40	0.17	380	
LB 3218T100□	RoHS	10	±10% ±20%	30	0.25	340	2.52
LB 3218T150□	RoHS	15		25	0.32	300	
LB 3218T220□	RoHS	22		19	0.49	255	
LB 3218T330□	RoHS	33		15	0.75	215	
LB 3218T470□	RoHS	47		12	0.92	205	
LB 3218T680□	RoHS	68		11	1.49	145	0.796
LB 3218T101□	RoHS	100		8.0	2.4	140	
LB 3218T151□	RoHS	150		7.0	3.2	105	
LB 3218T221□	RoHS	220		5.0	5.4	80	
LB 3218T331□	RoHS	330		4.0	7.0	65	
LB 3218T471□	RoHS	470		3.5	14	54	0.252
LB 3218T681□	RoHS	680		3.0	17	45	
LB 3218T102□	RoHS	1000		2.4	27	39	

LBMF1608 TYPE

形名 Ordering code	EHS (Environmental Hazardous Substances)	公称 インダクタンス Inductance [μH]	インダクタンス 許容差 Inductance Tolerance	自己共振 周波数 Self-resonant frequency [MHz] min.	直流抵抗 DC Resistance [Ω] (±30%)	定格電流 Rated current [mA] max.	測定 周波数 Measuring frequency [MHz]
LBMF1608T1R0M	RoHS	1.0	±20%	100	0.09	230	7.96
LBMF1608T2R2M	RoHS	2.2		80	0.17	160	
LBMF1608T3R3M	RoHS	3.3		60	0.22	130	
LBMF1608T4R7M	RoHS	4.7		45	0.24	110	
LBMF1608T100□	RoHS	10	±10% ±20%	32	0.36	80	2.52
LBMF1608T220□	RoHS	22		16	1.0	50	
LBMF1608T470□	RoHS	47		11	2.5	35	

LBC2518 TYPE

形名 Ordering code	EHS (Environmental Hazardous Substances)	公称 インダクタンス Inductance [μH]	インダクタンス 許容差 Inductance Tolerance	自己共振 周波数 Self-resonant frequency [MHz] min.	直流抵抗 DC Resistance [Ω] (±30%)	定格電流 Rated current [mA] max.	測定 周波数 Measuring frequency [MHz]
LB C2518T1R0M	RoHS	1.0	±20%	100	0.08	775	7.96
LB C2518T1R0MR	RoHS	1.0		100	0.065	890	
LB C2518T1R5M	RoHS	1.5		80	0.11	730	
LB C2518T2R2M	RoHS	2.2		68	0.13	630	
LB C2518T3R3M	RoHS	3.3		54	0.16	560	
LB C2518T4R7M	RoHS	4.7		41	0.20	510	
LB C2518T6R8M	RoHS	6.8		38	0.30	420	
LB C2518T100□	RoHS	10	±10% ±20%	30	0.36	375	2.52
LB C2518T150□	RoHS	15		23	0.65	285	
LB C2518T220□	RoHS	22		19	0.77	250	
LB C2518T330□	RoHS	33		15	1.5	185	
LB C2518T470□	RoHS	47		12	1.9	165	
LB C2518T680□	RoHS	68		9.5	2.8	140	0.796
LB C2518T101□	RoHS	100		9.0	3.7	125	
LB C2518T151□	RoHS	150		7.0	6.1	95	
LB C2518T221□	RoHS	220		5.5	8.4	80	
LB C2518T331□	RoHS	330		4.5	12.3	65	
LB C2518T471□	RoHS	470		3.5	22	50	0.252
LB C2518T681□	RoHS	680		3.0	28	45	

(注) 形名の□にはインダクタンス許容差記号 (MまたはK)が入ります。

・□Please specify the Inductance tolerance code (K or M)

LBC2016 TYPE

形名 Ordering code	EHS (Environmental Hazardous Substances)	公称 インダクタンス Inductance [μH]	インダクタンス 許容差 Inductance Tolerance	自己共振 周波数 Self-resonant frequency [MHz] min.	直流抵抗 DC Resistance [Ω] (±30%)	定格電流 Rated current [mA] max.	測定 周波数 Measuring frequency [MHz]
LB C2016T1R0M	RoHS	1.0	±20%	100	0.10	690	7.96
LB C2016T1R5M	RoHS	1.5		80	0.15	600	
LB C2016T2R2M	RoHS	2.2		70	0.20	520	
LB C2016T3R3M	RoHS	3.3		55	0.27	410	
LB C2016T4R7M	RoHS	4.7		45	0.37	355	
LB C2016T6R8M	RoHS	6.8	±10% ±20%	38	0.59	290	2.52
LB C2016T100□	RoHS	10		32	0.82	245	
LB C2016T150□	RoHS	15		28	1.2	200	
LB C2016T220□	RoHS	22		16	1.8	165	
LB C2016T330□	RoHS	33		14	2.8	135	
LB C2016T470□	RoHS	47		11	4.3	110	
LB C2016T680□	RoHS	68		10	7.0	95	
LB C2016T101□	RoHS	100	8	8.0	75	0.796	

LBC2012 TYPE

形名 Ordering code	EHS (Environmental Hazardous Substances)	公称 インダクタンス Inductance [μH]	インダクタンス 許容差 Inductance Tolerance	自己共振 周波数 Self-resonant frequency [MHz] min.	直流抵抗 DC Resistance [Ω] (±30%)	定格電流 Rated current [mA] max.	測定 周波数 Measuring frequency [MHz]
LB C2012T1R0M	RoHS	1.0	±20%	100	0.19	620	7.96
LB C2012T2R2M	RoHS	2.2		70	0.33	430	
LB C2012T4R7M	RoHS	4.7		45	0.50	295	
LB C2012T100□	RoHS	10	±10% ±20%	40	1.2	200	2.52
LB C2012T220□	RoHS	22		16	3.7	130	
LB C2012T470□	RoHS	47		11	5.8	90	

LBR2518 TYPE

形名 Ordering code	EHS (Environmental Hazardous Substances)	公称 インダクタンス Inductance [μH]	インダクタンス 許容差 Inductance Tolerance	自己共振 周波数 Self-resonant frequency [MHz] min.	直流抵抗 DC Resistance [Ω] (±30%)	定格電流 Rated current [mA] max.	測定 周波数 Measuring frequency [MHz]
LB R2518T1R0M	RoHS	1.0	±20%	100	0.045	960	7.96
LB R2518T2R2M	RoHS	2.2		68	0.07	480	
LB R2518T4R7M	RoHS	4.7		45	0.10	345	
LB R2518T100□	RoHS	10	±10% ±20%	30	0.19	235	2.52
LB R2518T220□	RoHS	22		19	0.44	175	
LB R2518T470□	RoHS	47		11	0.84	120	
LB R2518T101□	RoHS	100		9	1.89	80	0.796

LBR2012 TYPE

形名 Ordering code	EHS (Environmental Hazardous Substances)	公称 インダクタンス Inductance [μH]	インダクタンス 許容差 Inductance Tolerance	自己共振 周波数 Self-resonant frequency [MHz] min.	直流抵抗 DC Resistance [Ω] (±30%)	定格電流 Rated current [mA] max.	測定 周波数 Measuring frequency [MHz]
LB R2012T1R0M	RoHS	1.0	±20%	100	0.07	400	7.96
LB R2012T2R2M	RoHS	2.2		80	0.13	260	
LB R2012T4R7M	RoHS	4.7		45	0.24	200	
LB R2012T100□	RoHS	10	±10% ±20%	32	0.36	150	2.52
LB R2012T220□	RoHS	22		16	1.0	100	
LB R2012T470□	RoHS	47		11	1.7	75	
LB R2012T101□	RoHS	100		8	4.0	50	0.796

(注) 形名の□にはインダクタンス許容差記号 (MまたはK) が入ります。

・ □ Please specify the Inductance tolerance code (K or M)

直流重畳特性例 DC Bias characteristics (Measured by HP4285A+42841A)

○標準品 Standard Type

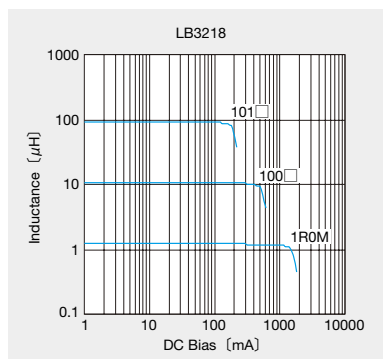
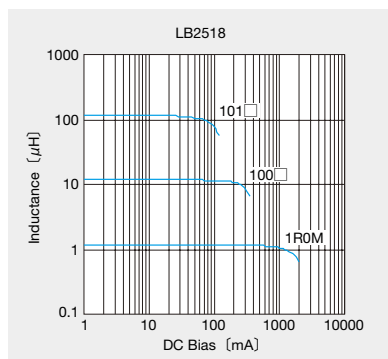
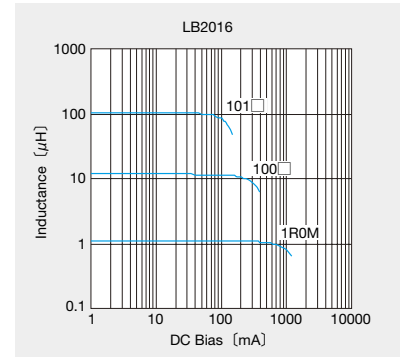
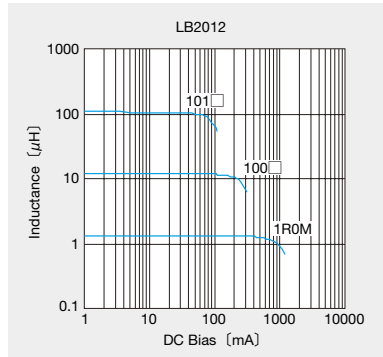
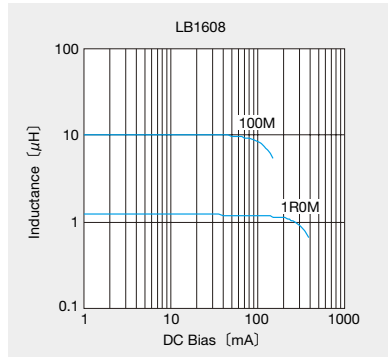

○大電流品 High Current Type

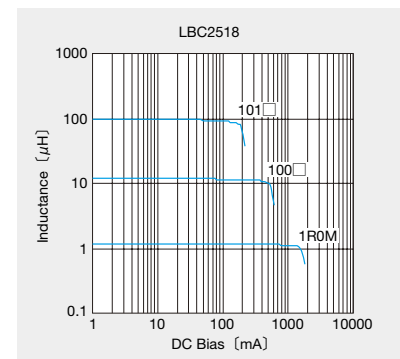
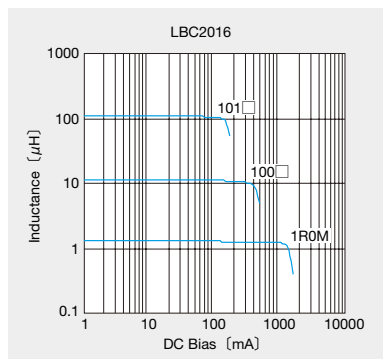
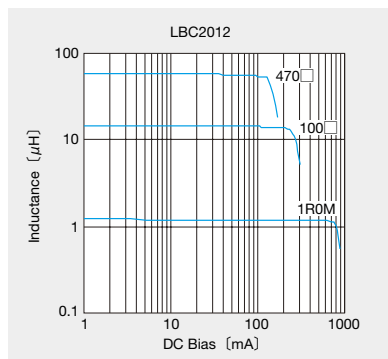

○低抵抗品 Low Rdc Type

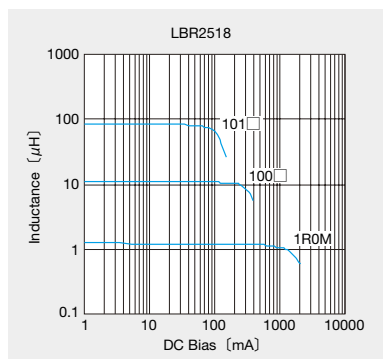
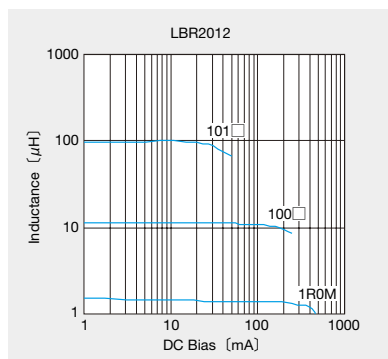

○下面電極品 Bottom-surface electrode Type

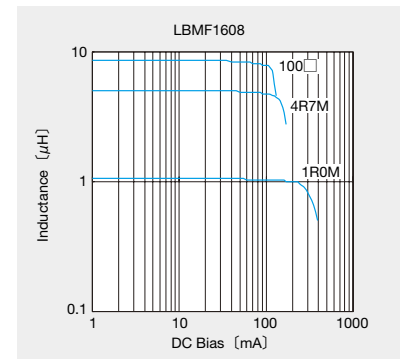

インピーダンス周波数 Impedance-vs-Frequency characteristics (Measured by HP4291A)

○標準品 Standard Type

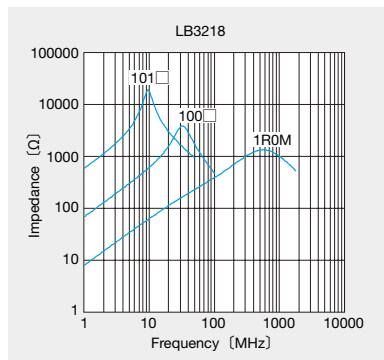
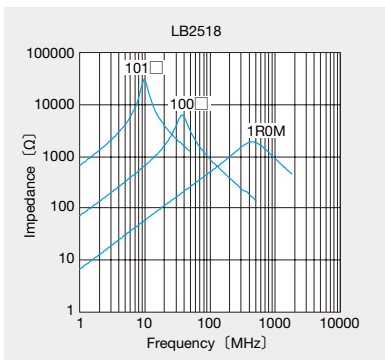
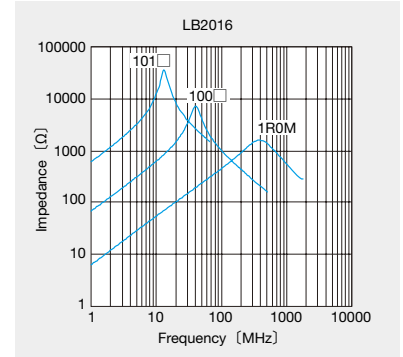
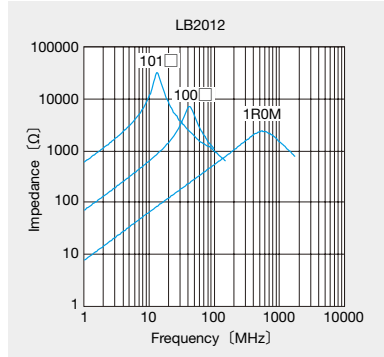
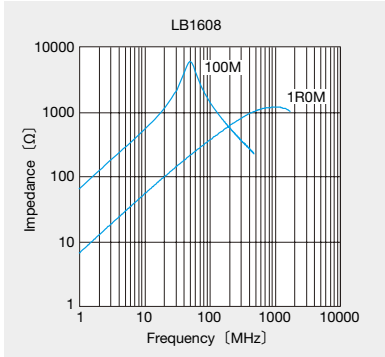

○大電流品 High Current Type

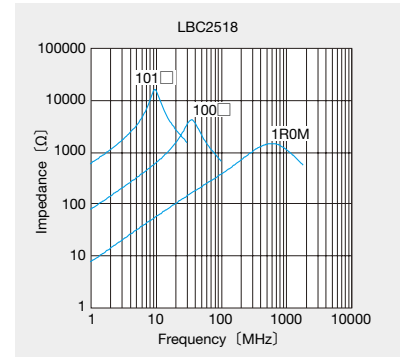
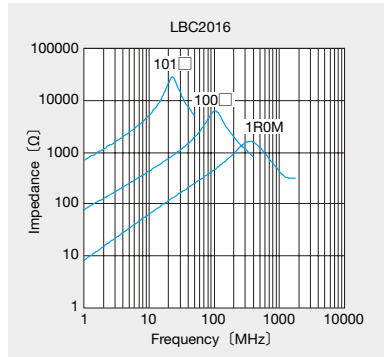
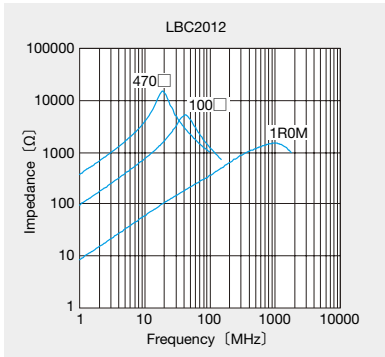

○低抵抗品 Low Rdc Type

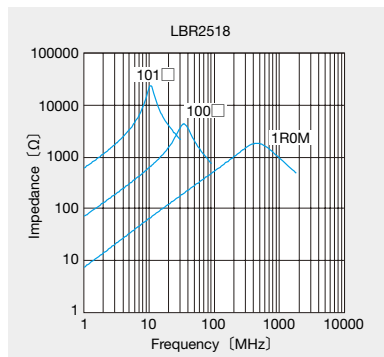
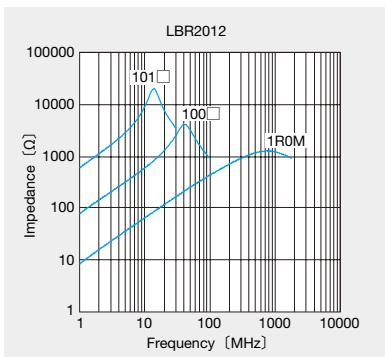

○下面電極品 Bottom-surface electrode Type

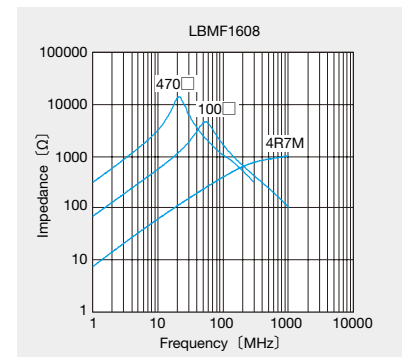

①最小受注単位数 Minimum Quantity

形式 Type	標準数量 Standard Quantity [pcs]	
	紙テーピング Paper Tape	エンボステーピング Embossed Tape
CBC3225	—	1000
LB3218	—	2000
LBR2518/LBC2518/LB2518 /CB2518/CBC2518/LEM2520	—	2000
LBM2016/LBC2016/LB2016 /CB2016/CBC2016	—	2000
LB2012/LBC2012/LBR202 /CB2012/CBC2012	—	3000
CBL2012	4000	—
LB1608	4000	—
LBMF1608/CBMF1608	—	3000

②テーピング材質 Tape material

エンボステープ Embossed tape

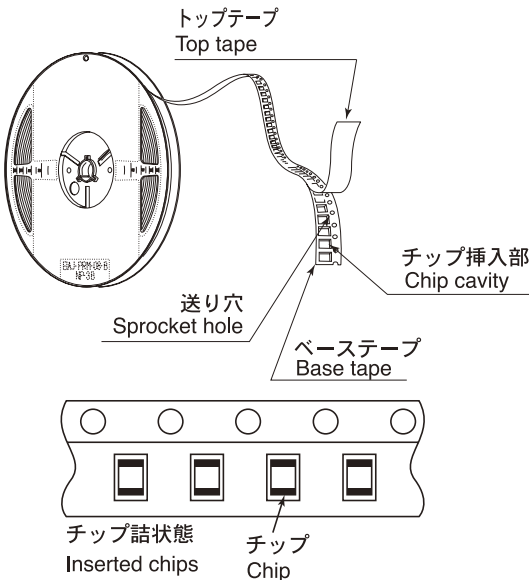

③テーピング寸法 Taping Dimensions

エンボステープ (8mm幅) Embossed Tape (0.315 inches wide)
紙テープ (8mm幅) Card board carrier tape (0.315 inches wide)

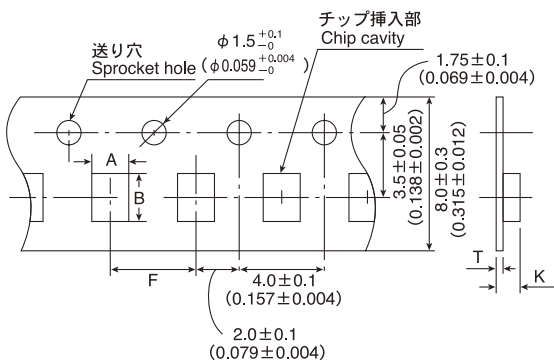

形式 Type	チップ挿入部 Chip cavity		挿入ピッチ Insertion pitch	テープ厚み Tape thickness	
	A	B	F	T	K
LBM 2016	1.9 ± 0.2 (0.075 ± 0.008)	2.2 ± 0.2 (0.087 ± 0.008)	4.0 ± 0.1 (0.157 ± 0.004)	0.3 (0.012)	2.15 (0.085)
LEM 2520	2.3 ± 0.1 (0.091 ± 0.004)	2.7 ± 0.1 (0.106 ± 0.004)	4.0 ± 0.1 (0.157 ± 0.004)	0.3 (0.012)	2.10 (0.083)
CBC3225	2.8 ± 0.1 (0.110 ± 0.004)	3.5 ± 0.1 (0.138 ± 0.004)	4.0 ± 0.1 (0.157 ± 0.004)	0.6max (0.024)	4.0max (0.157)
LB3218	2.1 ± 0.1 (0.084 ± 0.004)	3.5 ± 0.1 (0.014 ± 0.004)	4.0 ± 0.1 (0.157 ± 0.004)	0.3 (0.012)	2.3max (0.092)
LB2518 / CB2518 LBC2518 / CBC2518 LBR2518	2.15 ± 0.2 (0.085 ± 0.008)	2.7 ± 0.2 (0.107 ± 0.008)	4.0 ± 0.1 (0.157 ± 0.004)	0.3 (0.012)	2.10 (0.083)
LB2016 / CB2016 LBC2016 / CBC2016	1.9 ± 0.2 (0.075 ± 0.008)	2.2 ± 0.2 (0.087 ± 0.008)	4.0 ± 0.1 (0.157 ± 0.004)	0.3 (0.012)	2.15 (0.085)
LB2012 / CB2012 LBC2012 / CBC2012 LBR2012	1.45 ± 0.2 (0.058 ± 0.008)	2.25 ± 0.2 (0.09 ± 0.008)	4.0 ± 0.1 (0.157 ± 0.004)	0.25 (0.012)	2.0 (0.079)
CBL2012	1.55 ± 0.2 (0.061 ± 0.008)	2.3 ± 0.2 (0.091 ± 0.008)	4.0 ± 0.1 (0.157 ± 0.004)	1.1max (0.044)	1.1max (0.044)
LB1608	1.0 ± 0.2 (0.059 ± 0.008)	1.8 ± 0.2 (0.072 ± 0.008)	4.0 ± 0.1 (0.157 ± 0.004)	1.1max (0.044)	1.1max (0.044)
LBMF1608 / CBMF1608	1.1 ± 0.1 (0.04 ± 0.004)	1.9 ± 0.1 (0.076 ± 0.004)	3.5 ± 0.05 (0.14 ± 0.002)	0.3max (0.012)	1.6max (0.064)

④リーダー部/空部 Leader and Blank Portion

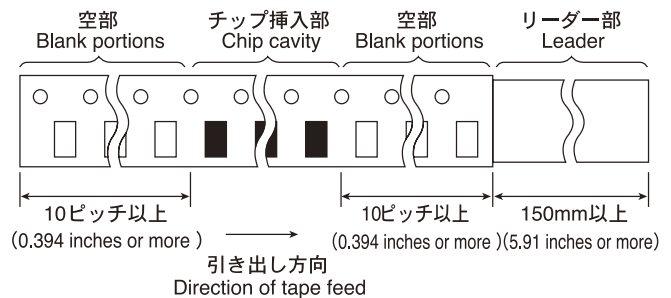

⑤リール寸法 Reel Size

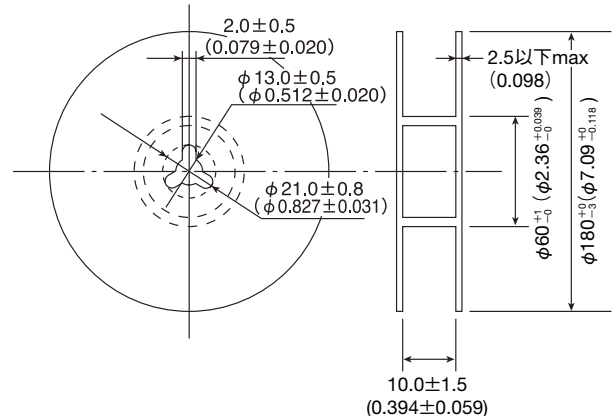

⑥トップテープ強度 Top Tape Strength

トップテープのはがし力は、下図矢印方向にて0.1~0.7Nとなります。
The top tape requires a peel-off force 0.1 to 0.7N in the direction of the arrow as illustrated below.

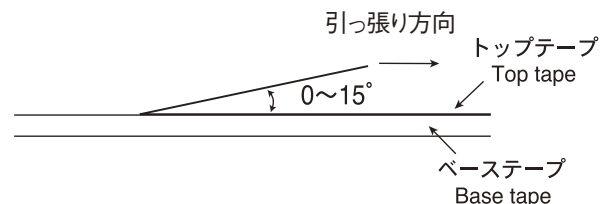

Item	Specified Value									Test Methods and Remarks
	LEM2520	LB3218 LB2518 LB2016 LB2012 LB1608 LBMF1608	LBC2518 LBC2016 LBC2012	LBR2518 LBR2012	CB2518 CB2016 CB2012	CBC3225 CBC2518 CBC2016 CBC2012	CBL2012	CBMF1608	LBM2016	
1. Operating temperature Range	-40~+85°C	-25~+105°C (Including self-generated heat)								
2. Storage	-40~+85°C									
3. Rated Current	Within the specified tolerance									LEM · LB · LBC · LBMF · LBM Series The maximum DC value having inductance decrease within 10% and temperature increase within 20°C by the application of DC bias. LBR Series The maximum DC value having inductance decrease within 20% and temperature increase within 20°C by the application of DC bias. CB · CBC · CBL · CBF Series The maximum DC value having inductance decrease within 30% and temperature increase within 40°C by the application of DC bias.
4. Inductance	Within the specified tolerance									LEM Series R12~101 : Measuring equipment : LCR Meter (HP4285A+42851A or its equivalent) Measuring frequency : Specified frequency LB · LBC · LBR · CB · CBC · CBL · LBMF · CBF · LBM Series : Measuring equipment : LCR Meter (HP4285A or its equivalent)
5. Q	Within the specified tolerance	/					Within the specified tolerance	LEM Series R12~101 : Measuring equipment : LCR Meter (HP4285A+42851A or its equivalent) Measuring frequency : Specified frequency LBM Series : Measuring equipment : LCR Meter (HP4285A or its equivalent)		
6. DC Resistance	Within the specified tolerance									LEM · LB · LBC · LBR · CB · CBC · CBL · LBM · LBMF · CBF Series : Measuring equipment : DC Ohmmeter (HIOKI 3227 or its equivalent)
7. Self-Resonant Frequency	Within the specified tolerance									LEM2520 : Measuring equipment : Impedance analyzer (HP4291A or its equivalent) LB · LBC · LBR · CB · CBC · CBL · LBMF · CBF Series : Measuring equipment : Impedance analyzer (HP4291A or its equivalent) LBM Series : Measuring equipment : Network analyzer (HP8720B or its equivalent)

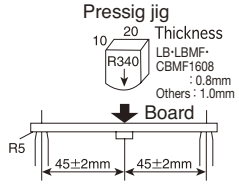
Item	Specified Value									Test Methods and Remarks												
	LEM2520	LB3218 LB2518 LB2016 LB2012 LB1608 LBMF1608	LBC2518 LBC2016 LBC2012	LBR2518 LBR2012	CB2518 CB2016 CB2012	CBC3225 CBC2518 CBC2016 CBC2012	CBL2012	CBMF1608	LBM2016													
8. Temperature Characteristic	Inductance change: Within ± 5%	Inductance change: Within ± 15%	LBC2518 LBC2016 Inductance change: Within ± 20%	Inductance change: Within ± 15%	Inductance change: Within ± 15%	CBC3225 CBC2518 CBC2016 Inductance change: Within ± 20%	Inductance change: Within ± 15%	Inductance change: Within ± 20%	Inductance change: Within ± 5%	Change of maximum inductance deviation in step 1-5 <table border="1"> <thead> <tr> <th>Step</th> <th>Temperature (°C)</th> </tr> </thead> <tbody> <tr> <td>1</td> <td>20</td> </tr> <tr> <td>2</td> <td>-25</td> </tr> <tr> <td>3</td> <td>20 (Reference temperature)</td> </tr> <tr> <td>4</td> <td>+85 (Maximum operating temperature)</td> </tr> <tr> <td>5</td> <td>20</td> </tr> </tbody> </table>	Step	Temperature (°C)	1	20	2	-25	3	20 (Reference temperature)	4	+85 (Maximum operating temperature)	5	20
Step	Temperature (°C)																					
1	20																					
2	-25																					
3	20 (Reference temperature)																					
4	+85 (Maximum operating temperature)																					
5	20																					
9. Resistance to Flexure of Substrate	No damage.									Warp: 2mm (LB, LBC, LBR, CB, CBC, CBL, LBM, LBMF, CBF Series) : 3mm (LEM2520) Test substrate: Printed board According to JIS C0051 												
10. Body Strength	No damage.									LB · LBC · LBR · CB · CBC · CBL · LBM · LEM2520 Applied force : 10N Duration : 10sec. LB1608 · LBMF1608 · CBF1608 Applied force : 5N Duration : 10sec.												
11. Self Resonant Frequency	Inductance change : Within - 10%		Inductance change: Within - 20%	Inductance change : Within - 30%			Inductance change: Within - 10%		Measure inductance with application of rated current using LCR metre to compare it with the initial value.													
12. Adhesion of terminal electrode	No abnormality.									LB · LBC · LBR · CB · CBC · CBL · LBM · LBMF · CBF · LEM2520 Applied force : 10N to X and Y directions Duration : 5 sec. Test substrate : Printed board												
13. Resistance to vibration	Inductance change: Within ± 5%	Inductance change : Within ± 10% No significant abnormality in appearance.						Inductance change: Within ± 5%	No significant abnormality in appearance.		LEM · LB · LBC · LBR · CB · CBC · CBL · LBM · LBMF · CBF : According to JIS C5102 clause 8.2. Vibration type : A Directions : 2 hrs each in X, Y and Z directions. Total : 6 hrs Frequency range : 10 to 55 to 10 Hz (1min.) Amplitude : 1.5mm Mounting method : Soldering onto printed board Recovery : At least 2 hrs of recovery under the standard condition after the test, followed by the measurement within 48 hrs.											

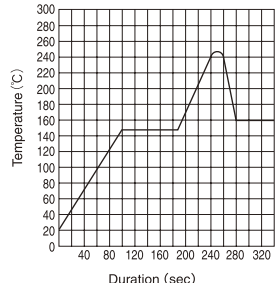
Item	Specified Value									Test Methods and Remarks
	LEM2520	LB3218 LB2518 LB2016 LB2012 LB1608 LBMF1608	LBC2518 LBC2016 LBC2012	LBR2518 LBR2012	CB2518 CB2016 CB2012	CBC3225 CBC2518 CBC2016 CBC2012	CBL2012	CBMF1608	LBM2016	
14.Drop test	Inductance change : Within ±5% No significant abnormality in appearance.								LEM : Acceleration : 980m/sec ² Duration : 6msec Number of times : 6 sides × 3 times Mounting method : Soldering onto printed board Recovery : At least 2 hrs of recovery under the standard condition after the test, followed by the measurement within 48 hrs.	
15.Solderability	At least 90% of surface of terminal electrode is covered by new solder.									LEM : Solder temperature : 230±5°C Duration : 5±0.5sec. Flux : Methanol solution with 25% of colophony LB · LBC · LBR · CB · CBC · CBL · LBM · LBMF · CBFM : Solder temperature : 245±5°C Duration : 5±0.5sec Flux : Methanol solution with 25% of colophony
16.Resistance to soldering heat	Inductance change : Within ±10% No significant abnormality in appearance.	LB3218 LB2518 LB2016 LB2012 LB1608 Inductance change : Within ±10% No significant abnormality in appearance. LBMF1608 Inductance change : Within ±20% No significant abnormality in appearance.	Inductance change : within ±10% No significant abnormality in appearance.			Inductance change : Within ±20% No significant abnormality in appearance.	Inductance change : Within ±5% No significant abnormality in appearance.	LEM : Reflow condition 3 times of reflow over at 220±5°C for 40sec. MAX, With Peak temperature at 240±5°C for 5 sec. MAX. (Refer to a Profile of chart below.)  Flow condition Solder temperature : 260±5°C Duration : 10±1sec. Once LB · LBC · LBR · CB · CBC · CBL · LBM · LBMF · CBFM : 3 times of reflow oven at 230°C MIN for 40sec. with peak temperature at 260 ⁺⁰ ₋₅ °C for 5sec.		
17.Resistance to solvent	No significant abnormality in appearance									Solvent temperature : Room temperature Type of solvent : Isopropyl alcohol (LEM2520 · LB · LBC · LBR · CB · CBC · CBL · LBM · LBMF · CBFM) Cleaning conditions : 90s. Immersion and cleaning. (LEM2520 · LB · LBC · LBR · CB · CBC · CBL · LBM · LBMF · CBFM)

Item	Specified Value									Test Methods and Remarks									
	LEM2520	LB3218 LB2518 LB2016 LB2012 LB1608 LBMF1608	LBC2518 LBC2016 LBC2012	LBR2518 LBR2012	CB2518 CB2016 CB2012	CBC3225 CBC2518 CBC2016 CBC2012	CBL2012	CBMF1608	LBM2016										
18. Thermal shock	Inductance change : Within ±10% Q→ R12~4R7 : 30min. 5R6~330 : 25min. 390~820 : 20min. 101 : 15min.	Inductance change :Within ±10% No significant abnormality in appearance.								LEM : Conditions for 1 cycle <table border="1"> <tr> <th>Step</th> <th>Temperature (°C)</th> <th>Duration (min)</th> </tr> <tr> <td>1</td> <td>-40</td> <td>30</td> </tr> <tr> <td>2</td> <td>+85</td> <td>30</td> </tr> </table> Number of cycle : 100 cycle Recovery : At least 1 hr of recovery the standard condition after the removal from test chamber, followed by the measurement within 2 hrs. LB · LBC · LBR · CB · CBC · CBL · LBM · LBMF · CBFM : -40~+85°C, maintain times 30min, 100 cycle Recovery : At least 2 hrs of recovery under the standard condition after the test, followed by the measurement within 48 hrs.	Step	Temperature (°C)	Duration (min)	1	-40	30	2	+85	30
Step	Temperature (°C)	Duration (min)																	
1	-40	30																	
2	+85	30																	
19. Damp heat	Inductance change : Within ±10% Q→ R12~4R7 : 30min. 5R6~330 : 25min. 390~820 : 20min. 101 : 15min.	Inductance change :Within ±10% No significant abnormality in appearance.								Temperature : 60±2°C Humidity : 90~95%RH Duration : 1000 hrs Recovery : At least 2 hrs of recovery under the standard condition after the test, followed by the measurement within 48 hrs.									
20. Loading under damp heat	Inductance change : Within ±10% Q→ R12~4R7 : 30min. 5R6~330 : 25min. 390~820 : 20min. 101 : 15min.	Inductance change : Within ±10% No significant abnormality in appearance.								LEM · LB · LBC · CB · CBC · CBL · LBM · LBMF · CBFM : Temperature : 60±2°C Humidity : 90~95%RH Duration : 1000 hrs Applied current : Rated current Recovery : At least 2 hrs of recovery under the standard condition after the test, followed by the measurement within 48 hrs.									
21. High temperature life test	Inductance change : Within ±10% Q→ R12~4R7 : 30min. 5R6~330 : 25min. 390~820 : 20min. 101 : 15min.	/			Inductance change :Within ±10% No significant abnormality in appearance.				LEM · CB · CBC · CBL · LBM · CBFM : Temperature : 85±2°C Duration : 1000 hrs Recovery : At least 2 hrs of recovery under the standard condition after the test, followed by the measurement within 48 hrs.										
22. Loading at high temperature		Inductance change :Within ±10% No significant abnormality in appearance.			/				LB · LBC · LBR · LBMF : Temperature : 85±2°C Duration : 1000 hrs Applied current : Rated current Recovery : At least 2 hrs of recovery under the standard condition after the test, followed by the measurement within 48 hrs.										

Item	Specified Value									Test Methods and Remarks
	LEM2520	LB3218 LB2518 LB2016 LB2012 LB1608 LBMF1608	LBC2518 LBC2016 LBC2012	LBR2518 LBR2012	CB2518 CB2016 CB2012	CBC3225 CBC2518 CBC2016 CBC2012	CBL2012	CBMF1608	LBM2016	
23.Low temperature life test	Inductance change : Within±10% Q→ R12~4R7 : 30min. 5R6~330 : 25min. 390~820 : 20min. 101 : 15min.	Inductance change :Within±10% No significant abnormality in appearance.								LEM・LB・LBC・LBR・CB・CBC・CBL・LBM・LBMF・CBMF Temperature : -40±2℃ Duration : 1000 hrs Recovery : At least 2 hrs of recovery under the standard condition after the test, followed by the measurement within 48 hrs.
24.Standard condition	Standard test condition : Unless otherwise specified,temperature is 20±15℃, and 65±20% of relative humidity.When there are question concerning measurement result : In order to provide correlation date, the test shall be condition of 20±2℃ of temperature, 65±5% relative humidity. Inductance is in accordance with our measured value.									

LEM Type, LB Type, CB Type

Stages	Precautions	Technical considerations																																				
1.Circuit Design	<p>Operating environment,</p> <p>1.The products described in this specification are intended for use in general electronic equipment,(office supply equipment, telecommunications systems, measuring equipment, and household equipment). They are not intended for use in mission-critical equipment or systems requiring special quality and high reliability (traffic systems, safety equipment, aerospace systems, nuclear control systems and medical equipment including life-support systems,) where product failure might result in loss of life, injury or damage. For such uses, contact TAIYO YUDEN Sales Department in advance.</p>																																					
2.PCB Design	<p>Land pattern design</p> <p>1.Please contact any of our offices for a land pattern, and refer to a recommended land pattern of a right figure or specifications.</p>	<p>PRECAUTIONS</p> <p>【Recommended Land Patterns】</p> <p>Surface Mounting</p> <ul style="list-style-type: none"> Mounting and soldering conditions should be checked beforehand. Applicable soldering process to this products is reflow soldering only. <p>Unit : mm</p> <p>Recommended Land Patterns</p> <table border="1"> <thead> <tr> <th>TYPE</th> <th>A</th> <th>B</th> <th>C</th> </tr> </thead> <tbody> <tr> <td>1608</td> <td>0.55</td> <td>0.7</td> <td>1.0</td> </tr> <tr> <td>MF1608</td> <td>0.55</td> <td>0.8</td> <td>1.0</td> </tr> <tr> <td>2012</td> <td>0.7</td> <td>0.8</td> <td>1.45</td> </tr> <tr> <td>2016</td> <td>0.7</td> <td>0.8</td> <td>1.8</td> </tr> <tr> <td>2518</td> <td>0.8</td> <td>1.2</td> <td>2.0</td> </tr> <tr> <td>LEM2520</td> <td>0.9</td> <td>1.5</td> <td>1.5</td> </tr> <tr> <td>3218</td> <td>1.0</td> <td>1.6</td> <td>2.0</td> </tr> <tr> <td>3225</td> <td>1.0</td> <td>1.6</td> <td>2.7</td> </tr> </tbody> </table>	TYPE	A	B	C	1608	0.55	0.7	1.0	MF1608	0.55	0.8	1.0	2012	0.7	0.8	1.45	2016	0.7	0.8	1.8	2518	0.8	1.2	2.0	LEM2520	0.9	1.5	1.5	3218	1.0	1.6	2.0	3225	1.0	1.6	2.7
TYPE	A	B	C																																			
1608	0.55	0.7	1.0																																			
MF1608	0.55	0.8	1.0																																			
2012	0.7	0.8	1.45																																			
2016	0.7	0.8	1.8																																			
2518	0.8	1.2	2.0																																			
LEM2520	0.9	1.5	1.5																																			
3218	1.0	1.6	2.0																																			
3225	1.0	1.6	2.7																																			
3.Considerations for automatic placement	<p>Adjustment of mounting machine</p> <p>1.Excessive impact load should not be imposed on the products when mounting onto the PC boards.</p> <p>2.Mounting and soldering conditions should be checked beforehand.</p>	<p>1. When installing products, care should be taken not to apply distortion stress as it may deform the products.</p>																																				
4.Soldering	<p>Wave soldering (LEM Type only)</p> <p>1.For wave soldering,please apply conditions meeting the range of the specified conditions in our catalog or the relevant specifications.</p> <p>Reflow soldering (LB and CB Types)</p> <p>1.For reflow soldering with either leaded or lead-free solder,the profile specified in "point for controlling" is recommended.</p> <p>Reflow soldering (LEM)</p> <p>1.For reflow soldering, please apply conditions meeting the range of the specified conditions in our catalog or the relevant specifications.</p> <p>Recommended conditions for using a soldering iron</p> <p>1.Put the soldering iron on the land-pattern. Soldering iron's temperature-Below 350°C Duration-3 seconds or less The soldering iron should not come in contact with inductor directly.</p>	<p>1.Components can be damaged by excessive heat whre soldering conditions exceed the specified range.</p> <p>1.Reflow profile</p> <p>1.Components can be damaged by excessive heat whre soldering conditions exceed the specified range.</p>																																				
5.Cleaning	<p>Cleaning conditions</p> <p>LEM Type, LB Type, CB Type</p> <p>1.Washing by supersonic waves shall be avoided.</p>	<p>LEM Type, LB Type, CB Type</p> <p>1.If washing by supersonic waves, supersonic waves may cause broken products.</p>																																				
6.Handling	<p>Handling</p> <p>1.Keep the inductors away from all magnets and magnetic objects.</p> <p>Breakaway PC boards (splitting along perforations)</p> <p>1.When splitting the PC board after mounting inductors, care should be taken not to give any stresses of deflection or twisting to the board.</p> <p>2.Board separation should not be done manually, but by using the appropriate devices.</p> <p>Mechanical considerations</p> <p>1.Please do not give the inductors any excessive mechanical shocks.</p>	<p>1.There is a case that a characteristic varies with magnetic influence.</p> <p>1.Planning pattern configurations and the position of products should be carefully performed to minimize stress.</p> <p>1.There is a case to be damaged by a mechanical shock.</p>																																				
7.Storage conditions	<p>Storage</p> <p>1.To maintain the solderability of terminal electrodes and to keep the packing material in good condition, temperature and humidity in the storage area should be controlled.</p> <p>Recommended conditions</p> <p>Ambient temperature 0~40°C Humidity Below 70% RH</p> <p>The ambient temperature must be kept below 30°C Even under ideal storage conditions, solderability of products electrodes may decrease as time passes. For this reason, LE type inductors should be used within one year from the time of delivery.</p> <p>LB type Please should be used within 6 months from the time of delivery.</p> <p>LE type In case of storage over 6 months, solderability shall be checked before actual usage.</p>	<p>1. Under a high temperature and humidity environment, problems such as reduced solderability caused by oxidation of terminal electrodes and deterioration of taping/packaging materials may take place.</p>																																				