

Thermal device circuit breaker - TCP 0,1A - 0712107

Please be informed that the data shown in this PDF Document is generated from our Online Catalog. Please find the complete data in the user's documentation. Our General Terms of Use for Downloads are valid (<http://download.phoenixcontact.com>)



Thermal miniature circuit breaker, pluggable in screw-type fuse terminal block UK 6-FSI/C and spring-cage fuse terminal block ST 4-FSI/C

The illustration shows version TCP 2A

Why buy this product

- A version with screw or spring-cage connection is used as a basic terminal block
- The reclosable thermal circuit breaker is available in ten nominal current levels ranging from 0.1 to 10 A
- Compact design
- The integrated switching function enables immediate reclosure and therefore ensures the availability of the system



Key commercial data

Packing unit	20 pc
GTIN	 4 017918 980337
Weight per Piece (excluding packing)	10.1 g
Custom tariff number	85362010
Country of origin	Indonesia

Technical data

General

Installation instructions	When mounted in rows, the nominal device current can be limited to just 80% or must be oversized accordingly.
Mounting type	On base element
Color	black
Number of positions	1
Surge voltage category	II
Insulating material	PPS
Inflammability class according to UL 94	V0

Electrical data

Fuse	Slow-blow
------	-----------

Thermal device circuit breaker - TCP 0,1A - 0712107

Technical data

Electrical data

Fuse type	Automatic device
Rated surge voltage	2.5 kV
Rated voltage	250 V AC
	65 V DC
Rated current I_n	0.1 A
Insulation resistance R_{iso}	> 100 M Ω (500 V DC)
Rated short-circuit switching capacity I_{cn}	0.6 A (250 V AC / 65 V DC)
	2.5 A (30 V DC)
Short-circuit switching capacity I_k	2000 A 250 V AC / UL 1077
	2000 A 72 V DC / UL 1077
Dielectric strength	3000 V AC (Actuation area)
	1500 V AC (Installation area)
Cycles, max.	6000 (At 1 x I_n , low-induction)
	3000 (At 1 x I_n , inductive)
	500 (At 2 x I_n , inductive)
Pollution degree	2
Surge voltage category	II
Insulating material group	IIIb

Dimensions

Height	24.4 mm
Width	8.2 mm
Depth	44.5 mm
Height NS 35/7,5	55 mm

Ambient conditions

Degree of protection	IP40 (Actuation area)
Ambient temperature (operation)	-20 °C ... 60 °C

Standards and Regulations

Standards/specifications	EN 60934
--------------------------	----------

Classifications

eCl@ss

eCl@ss 4.0	27141116
eCl@ss 4.1	27141116
eCl@ss 5.0	27141116
eCl@ss 5.1	27141116
eCl@ss 6.0	27141116
eCl@ss 7.0	27141116
eCl@ss 8.0	27141116

Thermal device circuit breaker - TCP 0,1A - 0712107

Classifications

ETIM

ETIM 2.0	EC000899
ETIM 3.0	EC000899
ETIM 4.0	EC000899
ETIM 5.0	EC000899

UNSPSC

UNSPSC 6.01	30211812
UNSPSC 7.0901	39121411
UNSPSC 11	39121411
UNSPSC 12.01	39121411
UNSPSC 13.2	39121411

Approvals

Approvals

Approvals

CSA / UL Recognized / VDE Zeichengenehmigung / cUL Recognized / cULus Recognized

Ex Approvals

Approvals submitted

Approval details

CSA	
Nominal current I _N	0.1 A
Nominal voltage U _N	250 V

UL Recognized

VDE Zeichengenehmigung

Thermal device circuit breaker - TCP 0,1A - 0712107

Approvals

cUL Recognized 

cULus Recognized 

Accessories

Accessories

Terminal marking

Flat zack marker sheet - ZBFM 5/WH:UNBEDRUCKT - 0803595



Flat zack marker sheet, Sheet, white, Unlabeled, Can be labeled with: Plotter, Mounting type: Snap into flat marker groove, For terminal block width: 5.2 mm, Lettering field: 5 x 4.5 mm

Flat zack marker sheet - ZBFM 5/OG:UNBEDRUCKT - 0807180



Flat zack marker sheet, Sheet, orange, Unlabeled, Can be labeled with: Plotter, Mounting type: Snap into flat marker groove, For terminal block width: 5.2 mm, Lettering field: 5 x 4.5 mm

Additional products

Fuse modular terminal block - ST 4-FSI/C - 3036372



Fuse modular terminal block, Connection method: Spring-cage connection, Cross section: 0.08 mm²- 6 mm², AWG: 28 - 10, Nominal current: 30 A, Nominal voltage: 400 V, Width: 8.2 mm, Fuse type: C, Fuse type: Flat, Mounting type: NS 35/7,5, NS 35/15, Color: black

Fuse modular terminal block - ST 4-FSI/C-LED 12 - 3036495



Fuse terminal block with LED for mounting on NS 35, for miniature circuit breakers, terminal width: 8.2 mm, color: Black

Thermal device circuit breaker - TCP 0,1A - 0712107

Accessories

Fuse modular terminal block - ST 4-FSI/C-LED 24 - 3036505



Fuse terminal block with LED for mounting on NS 35, for miniature circuit breakers, terminal width: 8.2 mm, color: Black

Fuse modular terminal block - UK 6-FSI/C - 3118203



Flat-type fuse terminal block, cross section: 0.2 - 6 mm², AWG: 26 - 8, width: 8.2 mm, color: black

Fuse modular terminal block - UK 6-FSI/C-LED12 - 3001925



Flat-type fuse terminal block, cross section: 0.2 - 6 mm², AWG: 26 - 8, width: 8.2 mm, color: black, with light indicator, voltage light indicator: 12 V DC, current light indicator: 2 mA

Fuse modular terminal block - UK 6-FSI/C-LED24 - 3001938



Flat-type fuse terminal block, cross section: 0.2 - 6 mm², AWG: 26 - 8, width: 8.2 mm, color: black, with light indicator, voltage light indicator: 24 V DC, current light indicator: 2 mA

Drawings

Thermal device circuit breaker - TCP 0,1A - 0712107

Diagram

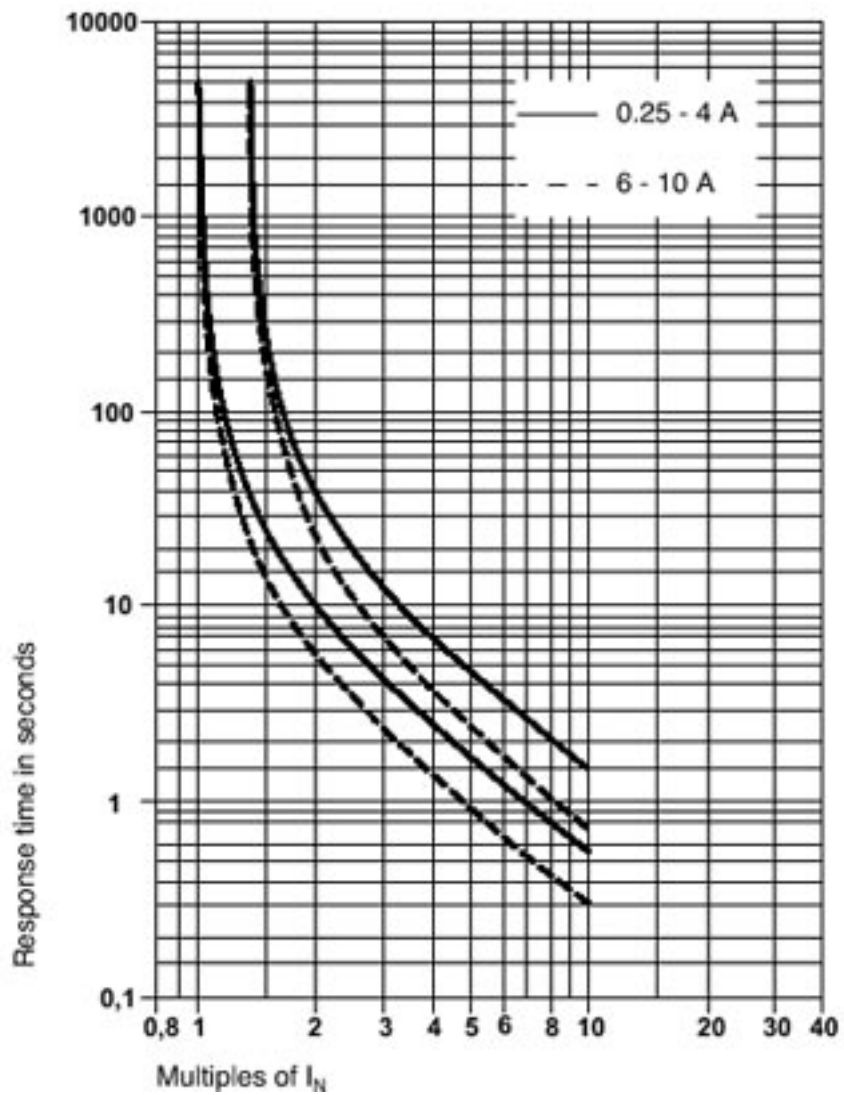

Thermal device circuit breaker - TCP 0,1A - 0712107

Application drawing

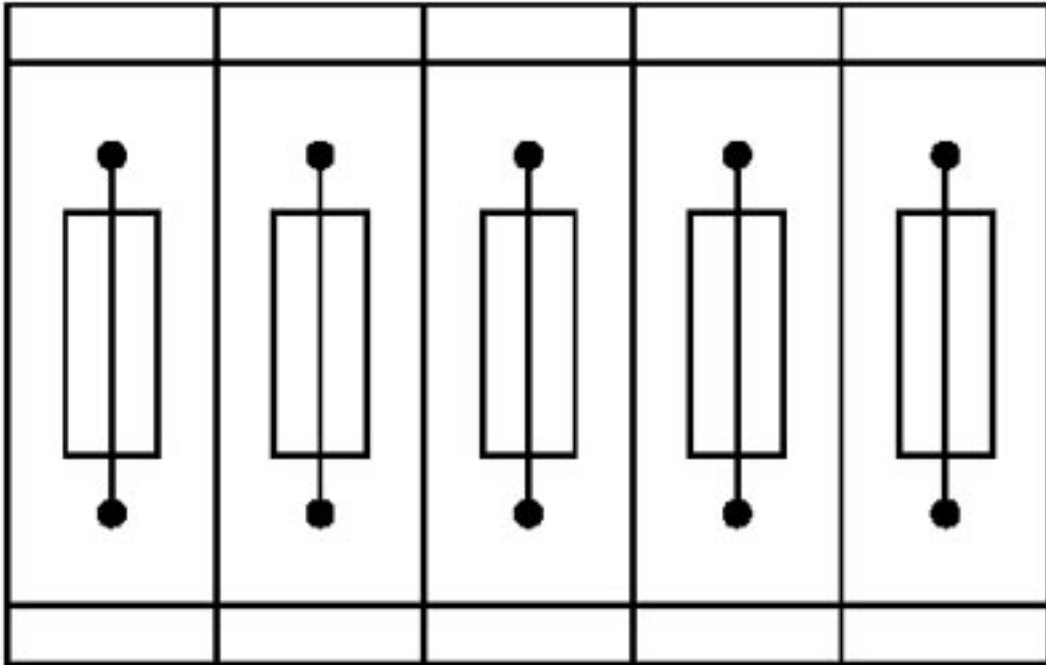

Fuse terminal blocks in interconnected arrangement,
block consisting of 5 fuse terminal blocks

Application drawing

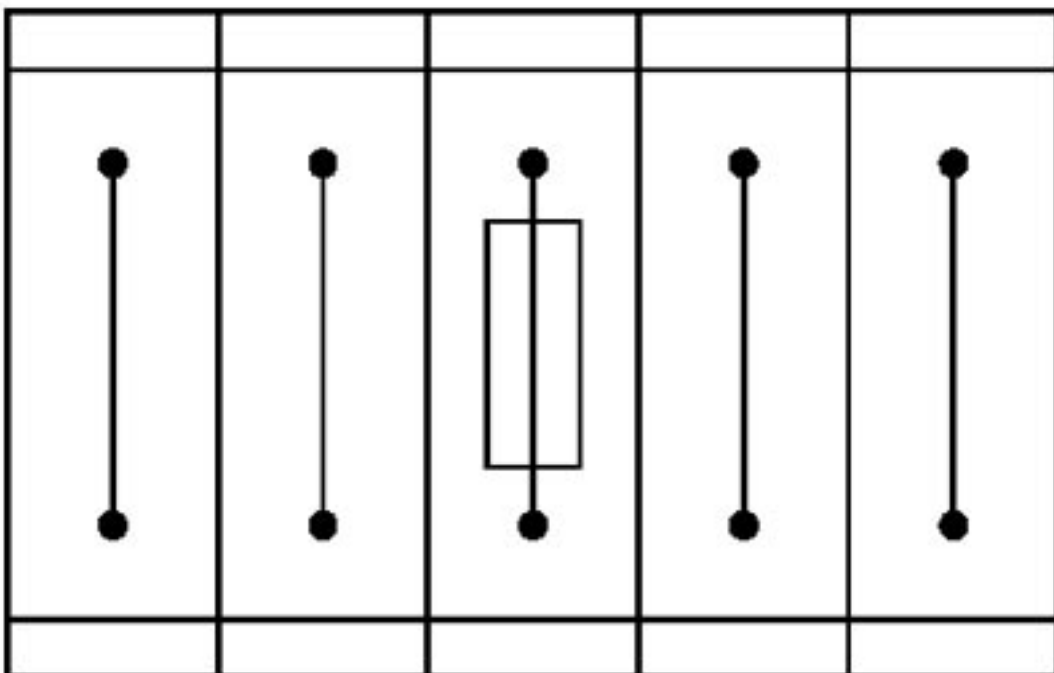

Fuse terminal block in single arrangement,

Thermal device circuit breaker - TCP 0,1A - 0712107

block consisting of one fuse terminal block and 4 feed-through terminal blocks

Dimensioned drawing

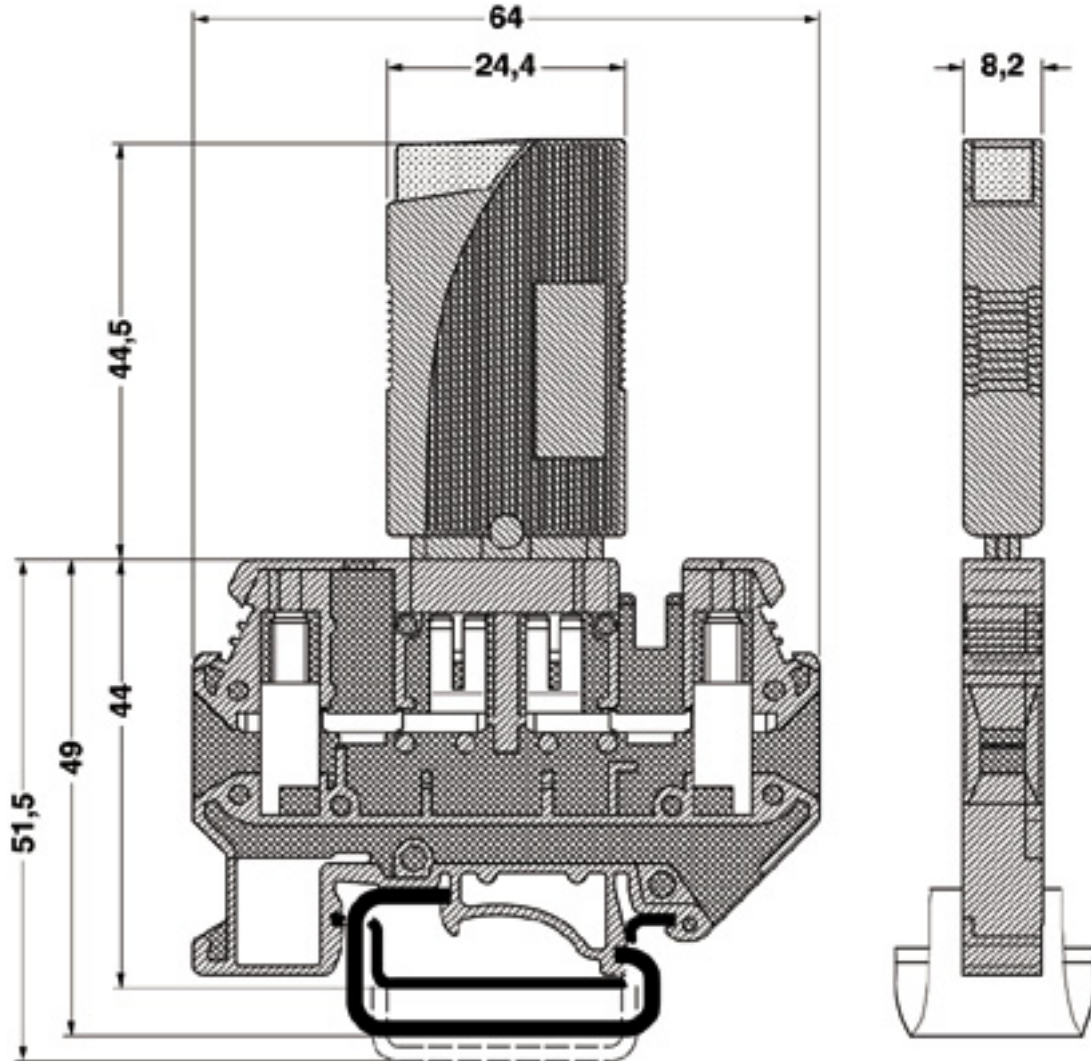

Thermal device circuit breaker - TCP 0,1A - 0712107

Dimensioned drawing

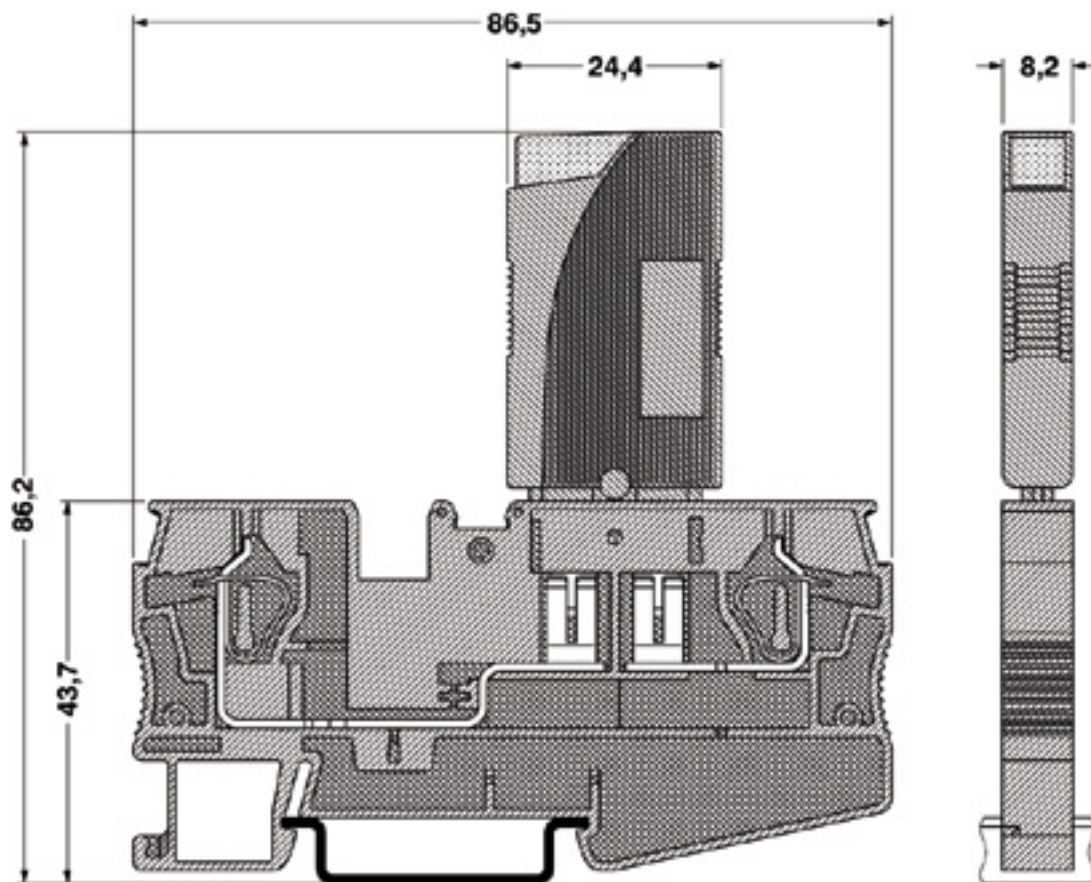

Thermal device circuit breaker - TCP 0,1A - 0712107

Application drawing

