

**PLEASE CHECK WWW.MOLEX.COM FOR LATEST PART INFORMATION**

**Part Number:** [50641-8141](#)  
**Status:** **Active**  
**Overview:** [PanelMate™ Wire-to-Board Connector System](#)  
**Description:** [PanelMate™ Crimp Terminal 50641, 28-30 AWG, Bag Gold \(Au\)](#)

**Documents:**

<a href="#">Drawing (PDF)</a>	<a href="#">Product Specification PS-51146-010 (PDF)</a>
<a href="#">Product Specification PS-51146-001 (PDF)</a>	<a href="#">Product Specification PS-51146-011 (PDF)</a>
<a href="#">Product Specification PS-51146-006 (PDF)</a>	<a href="#">Product Specification PS-51146-012 (PDF)</a>
<a href="#">Product Specification PS-51146-007 (PDF)</a>	<a href="#">Packaging Specification SPK-50641-001 (PDF)</a>
<a href="#">Product Specification PS-51146-008 (PDF)</a>	<a href="#">RoHS Certificate of Compliance (PDF)</a>
<a href="#">Product Specification PS-51146-009 (PDF)</a>	

**General**

Product Family	Crimp Terminals
Series	<a href="#">50641</a>
Application	Signal
Crimp Quality Equipment	Yes
MolexKits	Yes
Overview	<a href="#">PanelMate™ Wire-to-Board Connector System</a>
Packaging Alternative	<a href="#">50641-8041 (Reel)</a>
Product Name	PanelMate™
UPC	800754370691

**Physical**

Gender	Female
Material - Metal	Phosphor Bronze
Material - Plating Mating	Gold
Material - Plating Termination	Tin
Net Weight	20.001/mg
Packaging Type	Bag
Plating min - Mating	0.203µm
Plating min - Termination	0.203µm
Termination Interface: Style	Crimp or Compression
Wire Insulation Diameter	0.50-0.90mm
Wire Size AWG	28, 30
Wire Size mm²	N/A

**Material Info**

**Reference - Drawing Numbers**

Packaging Specification	SPK-50641-001
Product Specification	PS-51146-001, PS-51146-006, PS-51146-007, PS-51146-008, PS-51146-009, PS-51146-010, PS-51146-011, PS-51146-012, RPS-51146-002, RPS-51146-003, RPS-51146-004, RPS-51146-007, RPS-51146-008, RPS-51146-009, RPS-51146-013, RPS-51146-015, RPS-51146-017, RPS-51146-019, RPS-51146-022, RPS-51146-023, RPS-51146-024, RPS-51146-025, RPS-51146-026, RPS-51146-027, RPS-51146-029, RPS-51146-031, RPS-51146-034, RPS-51146-035
Sales Drawing	SD-50641-001

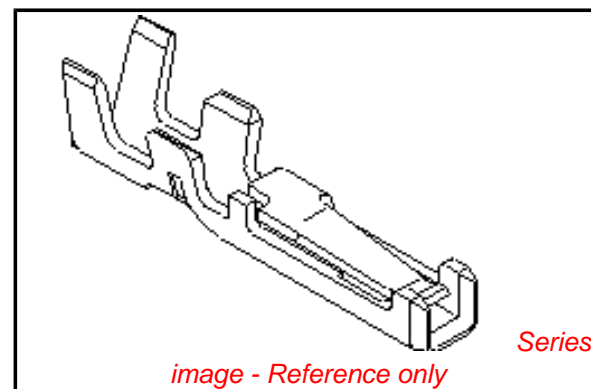

**EU RoHS**

**ELV and RoHS Compliant**  
**REACH SVHC Contains SVHC: No**  
**Low-Halogen Status Low-Halogen**

**China RoHS**



**Need more information on product environmental compliance?**

Email [productcompliance@molex.com](mailto:productcompliance@molex.com)  
 For a multiple part number RoHS Certificate of Compliance, [click here](#)

Please visit the [Contact Us](#) section for any non-product compliance questions.

**Search Parts in this Series**

50641Series

**Application Tooling | FAQ**

*Tooling specifications and manuals are found by selecting the products below. Crimp Height Specifications are then contained in the Application Tooling Specification document.*

**Global**

Description	Product #
Hand Crimp Tool, UL0638117900 Approved	
Extractor Tool for 1.25mm Pitch Wire-to-Board Crimp Terminal	<a href="#">0638133400</a>

**Japan**

Description	Product #
Hand Crimper	<a href="#">0573525100</a>
Hand Crimper	<a href="#">0573525000</a>

**PLEASE CHECK [WWW.MOLEX.COM](http://WWW.MOLEX.COM) FOR LATEST PART INFORMATION**