

RG125AC Series

Flatpak

180x180x40mm



- AC radial blower with external rotor shaded-pole motor. Impedance protected against overloading.
- Radial air exhaust through housing port. Rotational direction CW looking at rotor.
- Spiral housing and blower of fiber-glass reinforced plastic. Housing base of galvanised steel plate.
- Electrical connection via 2 leads AWG 22. Stripped and tinned ends.
- UL, CSA, VDE approvals on some models, please contact application engineering.

Part Number	Curve	CFM @ 0	VAC	Hertz	Power (W)	dBA	Max Amb. Temp C	Bearing Type	Features	Wgt. (lbs)
RG125-19/56	1	50.6	230	50	20	60	70	Ball	Leads	1.88
RG125-19/06	2	55.3	115	60	19	60	80	Ball	Leads	1.88

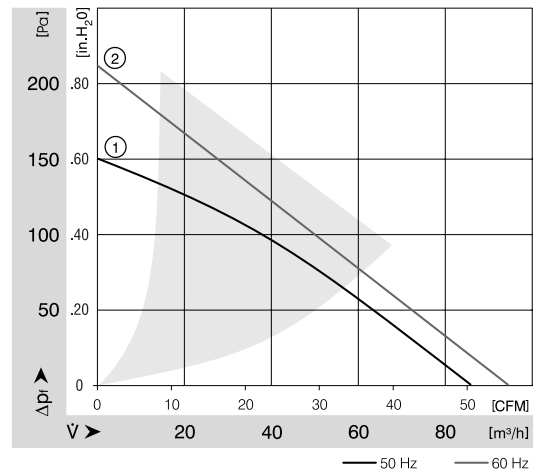
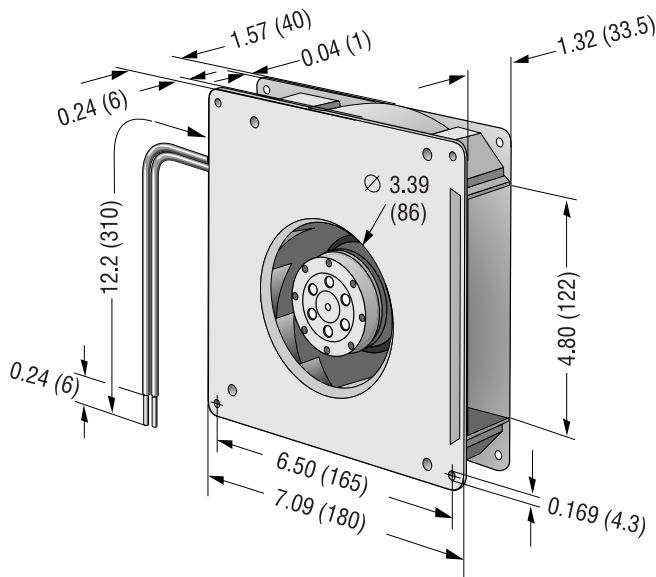

e-mail: sales@us.ebmpapst.com · TEL: 860-674-1515 · FAX: 860-674-8536
 ebm-papst Inc., 100 Hyde Road, Farmington, CT 06034 USA

ebm-papst Inc., 2005 © ebm-papst Inc. reserves the right to change any specifications or data without notice