

Base strip - MSTBA 2,5/12-G-5,08 - 1757349

Please be informed that the data shown in this PDF Document is generated from our Online Catalog. Please find the complete data in the user's documentation. Our General Terms of Use for Downloads are valid (<http://phoenixcontact.com/download>)

Header, Nominal current: 12 A, Rated voltage (III/2): 320 V, Number of positions: 12, Pitch: 5.08 mm, Color: green, Contact surface: Tin, Mounting: Soldering



The figure shows a 10-position version of the product

Why buy this product

- Other pin lengths available on request
- Plug-in direction parallel to the conductor axis
- W type with stand-off
- Standard pin strip for 320 V (III/2)
-



Key commercial data

Packing unit	50 pc
GTIN	 4 017918 029876
Weight per Piece (excluding packing)	4.0 g
Custom tariff number	85366990
Country of origin	Germany

Technical data

Dimensions

Length	12 mm
Height	12.1 mm
Width	62.88 mm
Pitch	5.08 mm
Dimension a	55.88 mm
Pin dimensions	1 x 1 mm
Hole diameter	1.4 mm

General

Range of articles	MSTBA 2,5/..-G
-------------------	----------------

Base strip - MSTBA 2,5/12-G-5,08 - 1757349

Technical data

General

Insulating material group	I
Rated surge voltage (III/3)	4 kV
Rated surge voltage (III/2)	4 kV
Rated surge voltage (II/2)	4 kV
Rated voltage (III/3)	250 V
Rated voltage (III/2)	320 V
Rated voltage (II/2)	400 V
Connection in acc. with standard	EN-VDE
Nominal current I_N	12 A
Maximum load current	12 A
Insulating material	PA
Inflammability class according to UL 94	V0
Color	green
Number of positions	12

Classifications

eCl@ss

eCl@ss 4.0	272607xx
eCl@ss 4.1	27260701
eCl@ss 5.0	27260701
eCl@ss 5.1	27260701
eCl@ss 6.0	27260704
eCl@ss 7.0	27440402
eCl@ss 8.0	27440402

ETIM

ETIM 3.0	EC001121
ETIM 4.0	EC002637
ETIM 5.0	EC002637

UNSPSC

UNSPSC 6.01	30211810
UNSPSC 7.0901	39121409
UNSPSC 11	39121409
UNSPSC 12.01	39121409
UNSPSC 13.2	39121409

Approvals

Approvals

Base strip - MSTBA 2,5/12-G-5,08 - 1757349

Approvals

Approvals

CSA / UL Recognized / VDE Gutachten mit Fertigungsüberwachung / cUL Recognized / IECCE CB Scheme / CCA / EAC / cULus Recognized

Ex Approvals

Approvals submitted

Approval details

CSA		
	B	D
Nominal current IN	15 A	10 A
Nominal voltage UN	300 V	300 V

UL Recognized		
	B	D
Nominal current IN	15 A	10 A
Nominal voltage UN	300 V	300 V

VDE Gutachten mit Fertigungsüberwachung	
Nominal current IN	12 A
Nominal voltage UN	250 V

cUL Recognized		
	B	D
Nominal current IN	15 A	10 A
Nominal voltage UN	300 V	300 V

Base strip - MSTBA 2,5/12-G-5,08 - 1757349

Approvals

IECEE CB Scheme	
Nominal current IN	12 A
Nominal voltage UN	250 V

CCA	
Nominal current IN	12 A
Nominal voltage UN	250 V

EAC	
-----	--

cULus Recognized	
------------------	--

Accessories

Accessories

Coding element

Coding star - CR-MSTB - 1734401



Coding section, inserted into the recess in the header or the inverted plug, red insulating material

Filler plug

Accessories - MSTB-BL - 1755477



Keying cap, for forming sections, plugs onto header pin, green insulating material

Labeled terminal marker

Base strip - MSTBA 2,5/12-G-5,08 - 1757349

Accessories

Marker card - SK 5,08/3,8:FORTL.ZAHLEN - 0804293



Marker card, Card, white, labeled, Horizontal: Consecutive numbers 1 - 10, 11 - 20, etc. up to 91 - (99)100, Mounting type: Adhesive, for terminal block width: 5.08 mm, Lettering field: 5.08 x 3.8 mm

Terminal marking

Marker card - SK 5,08/3,8:UNBEDRUCKT - 0805412



Marker card, Card, white, unlabeled, can be labeled with: Marker pen, Mounting type: Adhesive, for terminal block width: 5.08 mm, Lettering field: 5.08 x 3.8 mm

Additional products

Printed-circuit board connector - MSTB 2,5/12-ST-5,08 - 1757116



Plug component, Nominal current: 12 A, Rated voltage (III/2): 320 V, Number of positions: 12, Pitch: 5.08 mm, Connection method: Screw connection, Color: green, Contact surface: Tin

Printed-circuit board connector - FRONT-MSTB 2,5/12-ST-5,08 - 1777387



Plug component, Nominal current: 12 A, Rated voltage (III/2): 320 V, Number of positions: 12, Pitch: 5.08 mm, Connection method: Screw connection, Color: green, Contact surface: Tin

Base strip - IC 2,5/12-G-5,08 - 1786501



Header, Nominal current: 12 A, Rated voltage (III/2): 320 V, Number of positions: 12, Pitch: 5.08 mm, Color: green, Contact surface: Tin, Mounting: Soldering

Base strip - MSTBA 2,5/12-G-5,08 - 1757349

Accessories

Printed-circuit board connector - MSTBU 2,5/12-ST-5,08-FL - 1824450



Plug component, Nominal current: 12 A, Rated voltage (III/2): 320 V, Number of positions: 12, Pitch: 5.08 mm, Connection method: Screw connection, Color: green, Contact surface: Tin, Mounting: Direct mounting

Printed-circuit board connector - MSTBVK 2,5/12-ST-5,08 - 1831414



Plug component, Nominal current: 12 A, Rated voltage (III/2): 320 V, Number of positions: 12, Pitch: 5.08 mm, Connection method: Screw connection, Color: green, Contact surface: Tin, Mounting: DIN rail

Printed-circuit board connector - UMSTBVK 2,5/12-ST-5,08 - 1833917



Plug component, Nominal current: 12 A, Rated voltage (III/2): 320 V, Number of positions: 12, Pitch: 5.08 mm, Connection method: Screw connection, Color: green, Contact surface: Tin, Mounting: DIN rail

Printed-circuit board connector - QC 1/12-ST-5,08 - 1883705

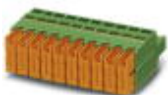

Plug component, Nominal current: 10 A, Rated voltage (III/2): 630 V, Number of positions: 12, Pitch: 5.08 mm, Connection method: Insulation displacement connection QUICKON, Color: green, Contact surface: Tin

Printed-circuit board connector - FKCVR 2,5/12-ST-5,08 - 1874057



Plug component, Nominal current: 12 A, Rated voltage (III/2): 320 V, Number of positions: 12, Pitch: 5.08 mm, Connection method: Push-in spring connection, Color: green, Contact surface: Tin

Base strip - MSTBA 2,5/12-G-5,08 - 1757349

Accessories

Printed-circuit board connector - FKCVW 2,5/12-ST-5,08 - 1873757

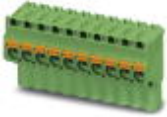

Plug component, Nominal current: 12 A, Rated voltage (III/2): 320 V, Number of positions: 12, Pitch: 5.08 mm, Connection method: Push-in spring connection, Color: green, Contact surface: Tin

Printed-circuit board connector - FKC 2,5/12-ST-5,08 - 1873155



Plug component, Nominal current: 12 A, Rated voltage (III/2): 320 V, Number of positions: 12, Pitch: 5.08 mm, Connection method: Push-in spring connection, Color: green, Contact surface: Tin

Base strip - A-ICV 2,5/12-G-5,08 - 1872790



Base strip, Nominal current: 12 A, Nominal voltage: 250 V, Mounting type: DIN rail mounting, Number of positions: 12, Pitch: 5.08 mm, Color: green

Printed-circuit board connector - SMSTB 2,5/12-ST-5,08 - 1826380



Plug component, Nominal current: 12 A, Rated voltage (III/2): 320 V, Number of positions: 12, Pitch: 5.08 mm, Connection method: Screw connection, Color: green, Contact surface: Tin

Printed-circuit board connector - MSTBU 2,5/12-STD-5,08 - 1824227



Plug component, Nominal current: 12 A, Rated voltage (III/2): 320 V, Number of positions: 12, Pitch: 5.08 mm, Connection method: Screw connection, Color: green, Contact surface: Tin, Mounting: Direct mounting

Base strip - MSTBA 2,5/12-G-5,08 - 1757349

Accessories

Printed-circuit board connector - MSTBC 2,5/12-STZ-5,08 - 1809608



Plug component, Nominal current: 12 A, Rated voltage (III/2): 320 V, Number of positions: 12, Pitch: 5.08 mm, Connection method: Crimp connection, Color: green, Corresponding female crimp contacts with current [A] and conductor cross section range [mm²] data: 10A/MSTBC-MT 0,5-1,0 (3190564); 10A/MSTBC-MT 0,5-1,0 BA (3190645); 12A/MSTBC-MT 1,5-2,5 (3190551); 12A/MSTBC-MT 1,5-2,5 BA (3190658). BA = Bandkontakte

Printed-circuit board connector - MSTBC 2,5/12-ST-5,08 - 1808913



Plug component, Nominal current: 12 A, Rated voltage (III/2): 320 V, Number of positions: 12, Pitch: 5.08 mm, Connection method: Crimp connection, Color: green, Corresponding female crimp contacts with current [A] and conductor cross section range [mm²] data: 10A/MSTBC-MT 0,5-1,0 (3190564); 10A/MSTBC-MT 0,5-1,0 BA (3190645); 12A/MSTBC-MT 1,5-2,5 (3190551); 12A/MSTBC-MT 1,5-2,5 BA (3190658). BA = Bandkontakte

Printed-circuit board connector - MVSTBW 2,5/12-ST-5,08 - 1792854



Plug component, Nominal current: 12 A, Rated voltage (III/2): 320 V, Number of positions: 12, Pitch: 5.08 mm, Connection method: Screw connection, Color: green, Contact surface: Tin

Printed-circuit board connector - MVSTBR 2,5/12-ST-5,08 - 1792346



Plug component, Nominal current: 12 A, Rated voltage (III/2): 320 V, Number of positions: 12, Pitch: 5.08 mm, Connection method: Screw connection, Color: green, Contact surface: Tin

Base strip - ICV 2,5/12-G-5,08 - 1786048



Header, Nominal current: 12 A, Rated voltage (III/2): 320 V, Number of positions: 12, Pitch: 5.08 mm, Color: green, Contact surface: Tin, Mounting: Soldering

Base strip - MSTBA 2,5/12-G-5,08 - 1757349

Accessories

Printed-circuit board connector - MSTBT 2,5/12-ST-5,08 - 1781085

Plug component, Nominal current: 12 A, Rated voltage (III/2): 320 V, Number of positions: 12, Pitch: 5.08 mm, Connection method: Screw connection, Color: green, Contact surface: Tin



Printed-circuit board connector - MSTBP 2,5/12-ST-5,08 - 1769117

Plug component, Nominal current: 12 A, Rated voltage (III/2): 320 V, Number of positions: 12, Pitch: 5.08 mm, Connection method: Screw connection, Color: green, Contact surface: Tin



Printed-circuit board connector - MSTB 2,5/12-STZ-5,08 - 1764280

Plug component, Nominal current: 12 A, Rated voltage (III/2): 320 V, Number of positions: 12, Pitch: 5.08 mm, Connection method: Screw connection, Color: green, Contact surface: Tin



Printed-circuit board connector - FKCT 2,5/12-ST-5,08 - 1902217

Plug component, Nominal current: 12 A, Rated voltage (III/2): 320 V, Number of positions: 12, Pitch: 5.08 mm, Connection method: Push-in spring connection, Color: green, Contact surface: Tin



Drawings

Drilling diagram

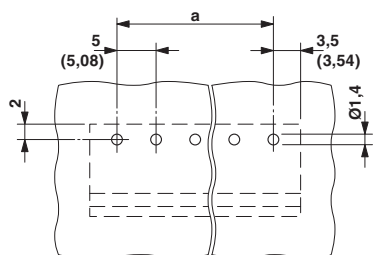

Diagram

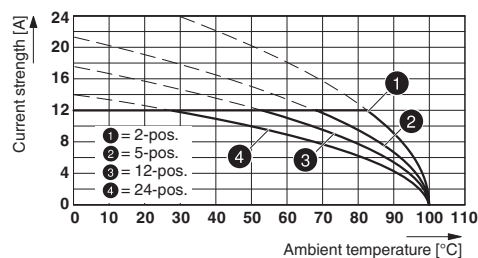

Type: ICV 2,5/...-G-5,08 with MSTBA 2,5/...-G-5,08

Base strip - MSTBA 2,5/12-G-5,08 - 1757349

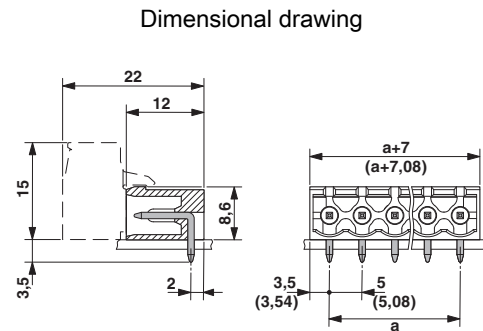
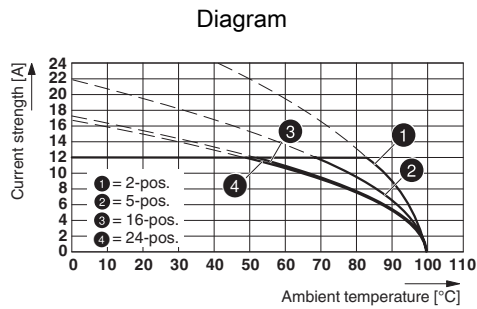

Type: IC 2,5/...-G-5,08 with MSTBA 2,5/...-G-5,08

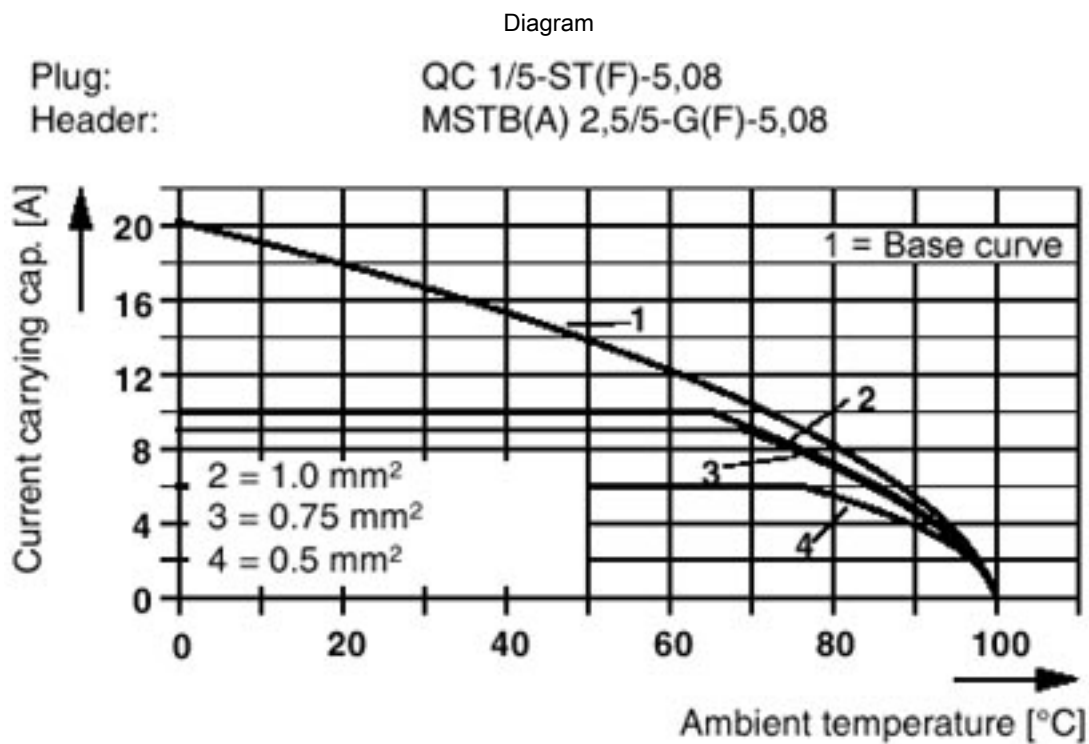

Base strip - MSTBA 2,5/12-G-5,08 - 1757349

Diagram

Plug: MSTBT 2,5/5-ST(F)-(-5,08)
Header: MSTB(A) 2,5/5-G(F)-(-5,08)

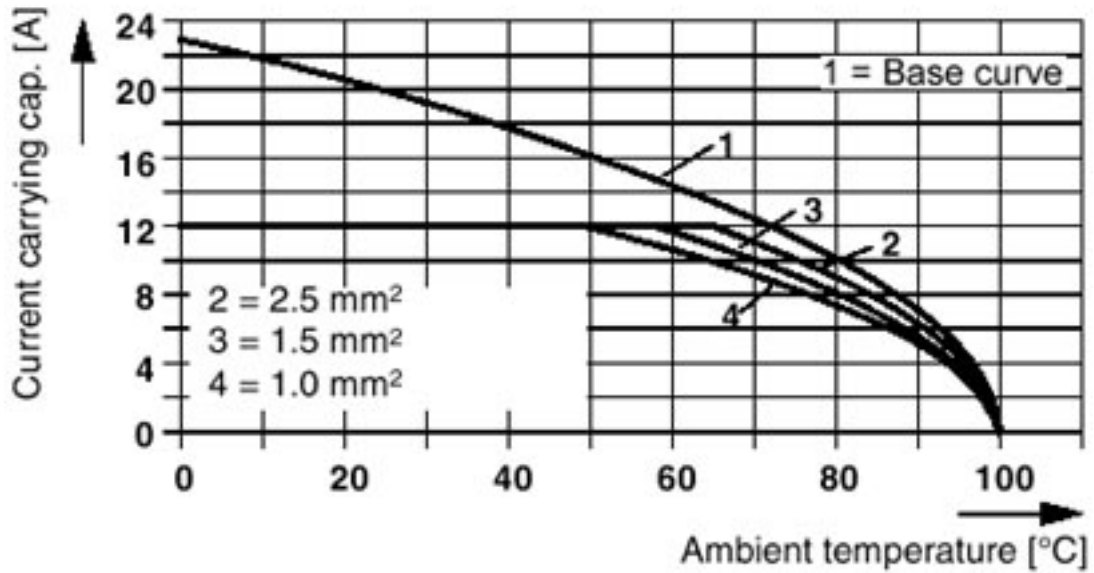

Diagram

Plug: SMSTB 2,5/5-ST(F)-(-5,08)
Header: MSTB(A) 2,5/5-G(F)-(-5,08)

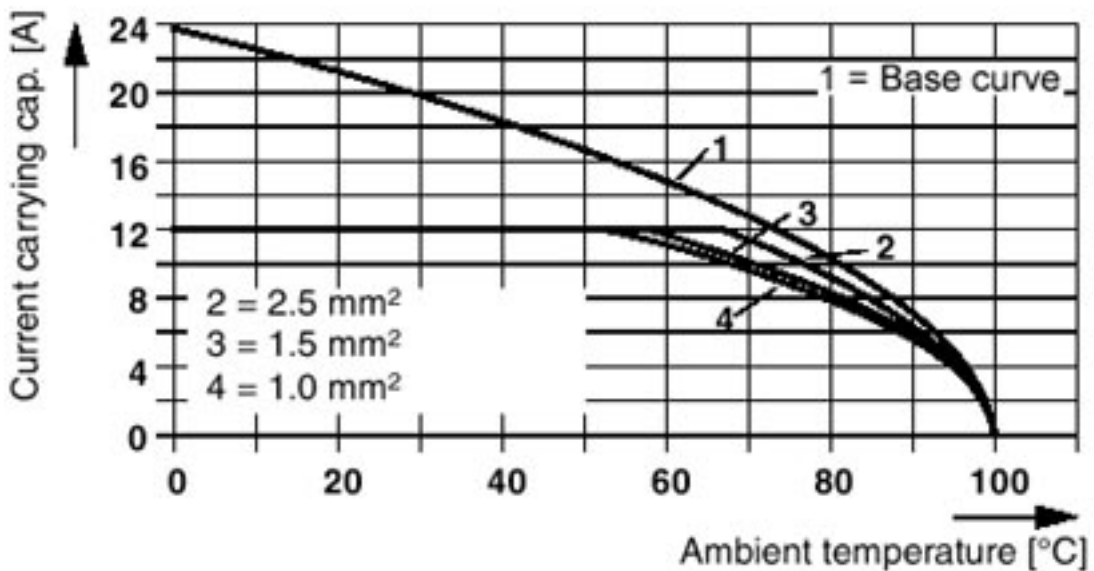

Base strip - MSTBA 2,5/12-G-5,08 - 1757349

Diagram

Plug: MVSTBR(W) 2,5/5-ST(F)-(5,08)
 Header: MSTB(A) 2,5/5-G(F)-(5,08)

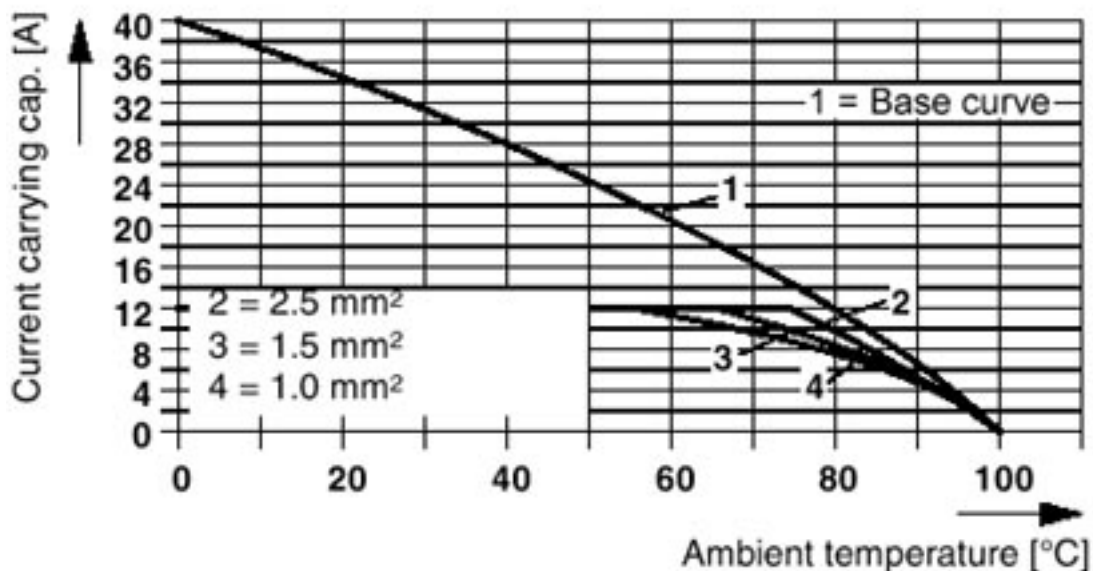

Diagram

Plug: FRONT-MSTB 2,5/5-ST(F)-(5,08)
 Header: MSTB(A) 2,5/5-G(F)-(5,08)

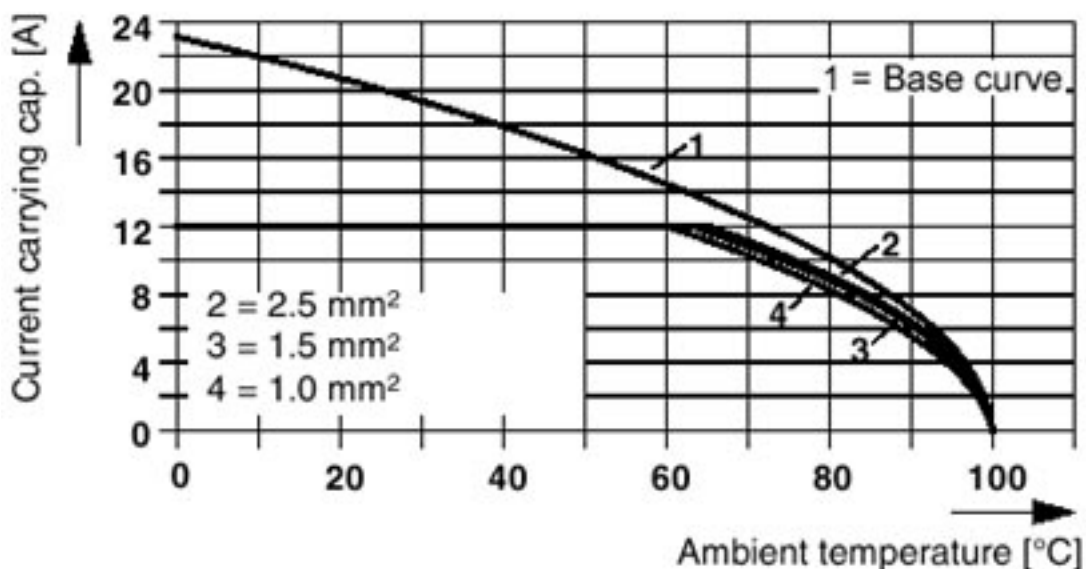

Base strip - MSTBA 2,5/12-G-5,08 - 1757349

Diagram

Plug: TMSTBP 2,5/5-ST(F)-(-5,08)
Header: MSTB(A) 2,5/5-G(F)-(-5,08)

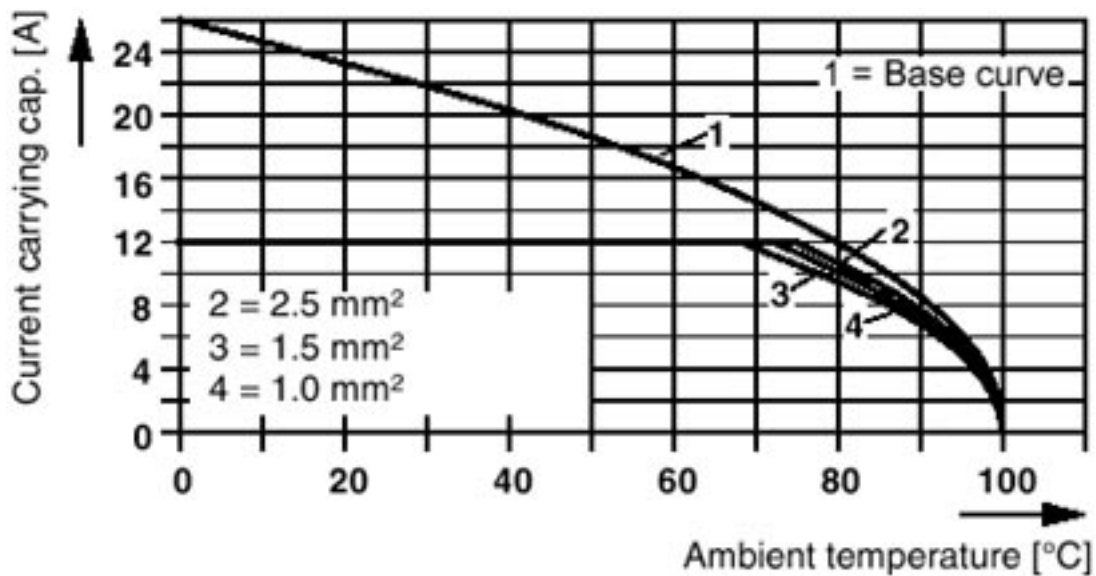

Diagram

Plug: FKC 2,5/5-ST(F)-5,08
Header: MSTB(A) 2,5/5-G(F)-5,08

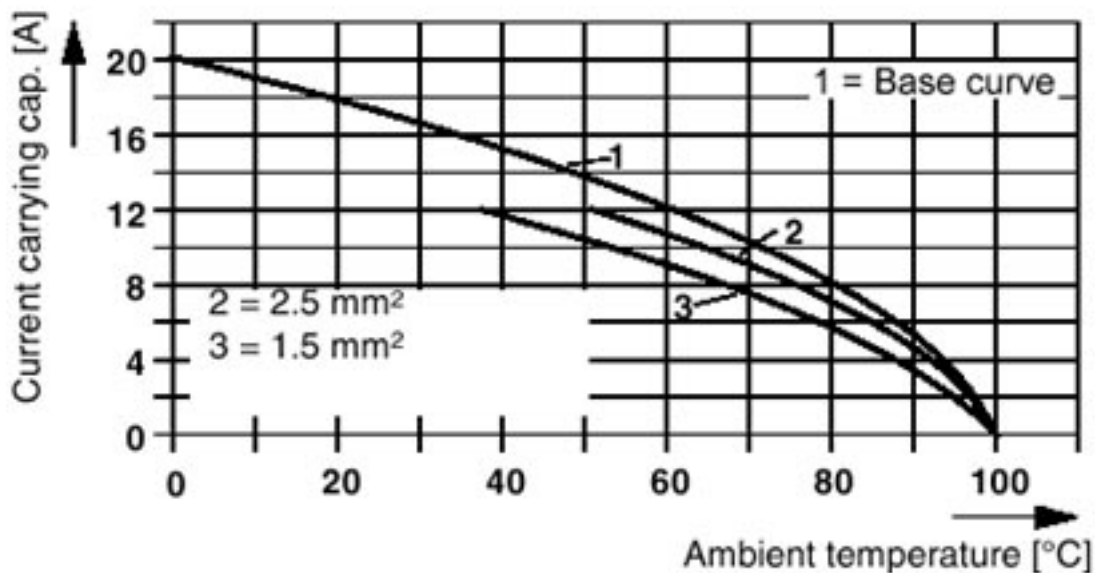

Base strip - MSTBA 2,5/12-G-5,08 - 1757349

Diagram

Plug: FKCVR(W) 2,5/5-ST(F)-5,08
Header: MSTB(A) 2,5/5-G(F)-5,08

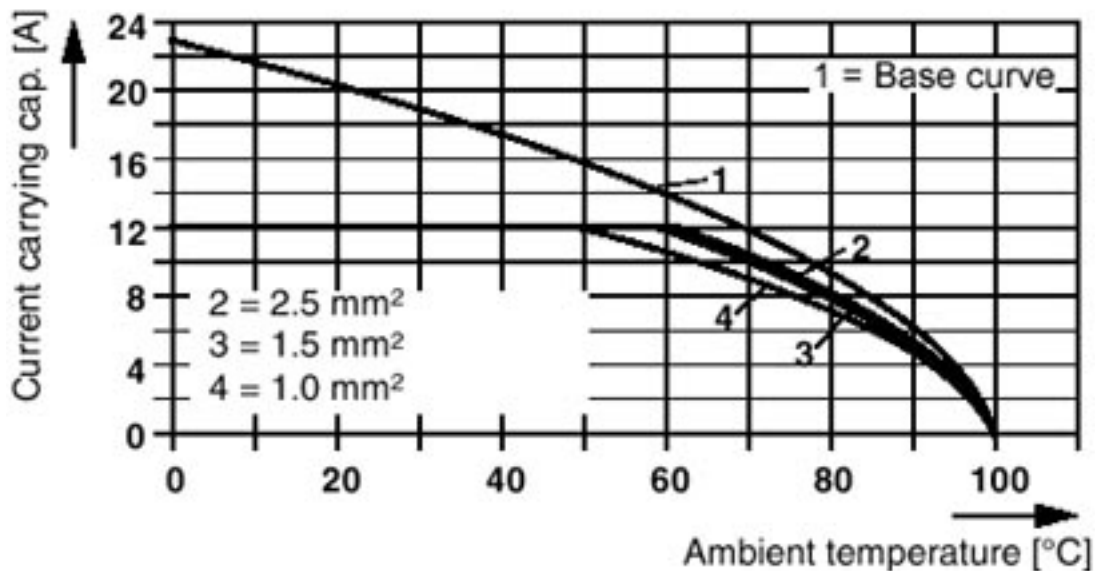

Diagram

Plug: MSTB 2,5/5-ST(F)(-5,08)
Header: MSTBO 2,5/5-GR(L)(-5,08)

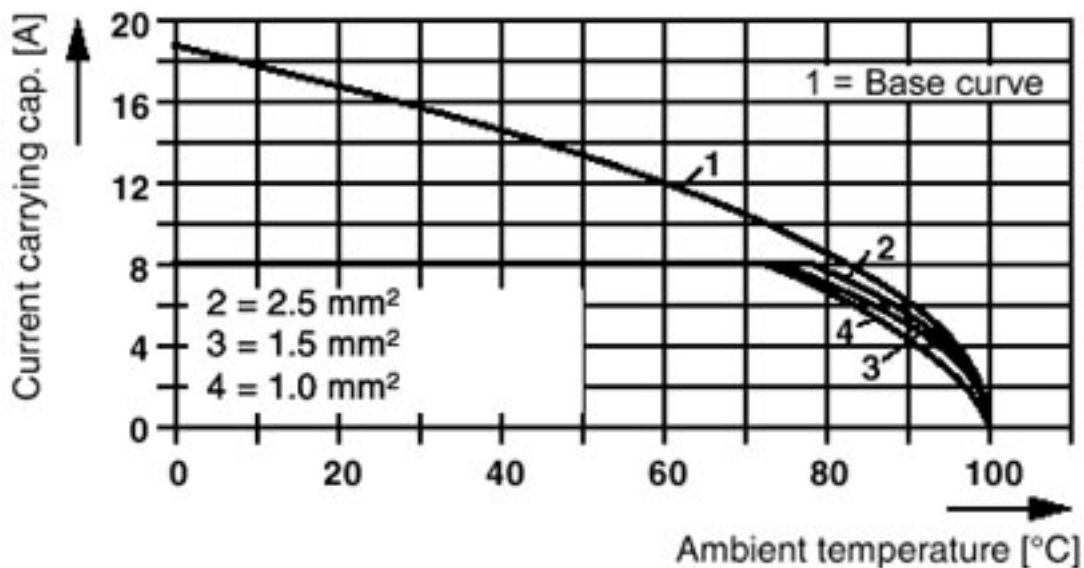

Base strip - MSTBA 2,5/12-G-5,08 - 1757349

Diagram

Plug: MSTB 2,5/5-ST(F)-(-5,08)
Header: MSTB(A) 2,5/5-G(F)-(-5,08)

