

# Process Pump (Diaphragm Pump)

CE RoHS **New**

Compact, large capacity diaphragm pump, suitable for transferring and collecting a wide range of fluids

palmtop size

Smaller, lighter, **25%\*** reduction in volume  
\* PB1013A/Air-operated type without foot (Comparison with current PB series)

Long service life **1.5 times** Discharge **8 to 2000 ml/min\***  
(Comparison with current PB series) \* PB1013A and PB1313A are available up to 1000 ml/min.

Weight **0.11 kg**  
\* PB1013A/Air-operated type without foot

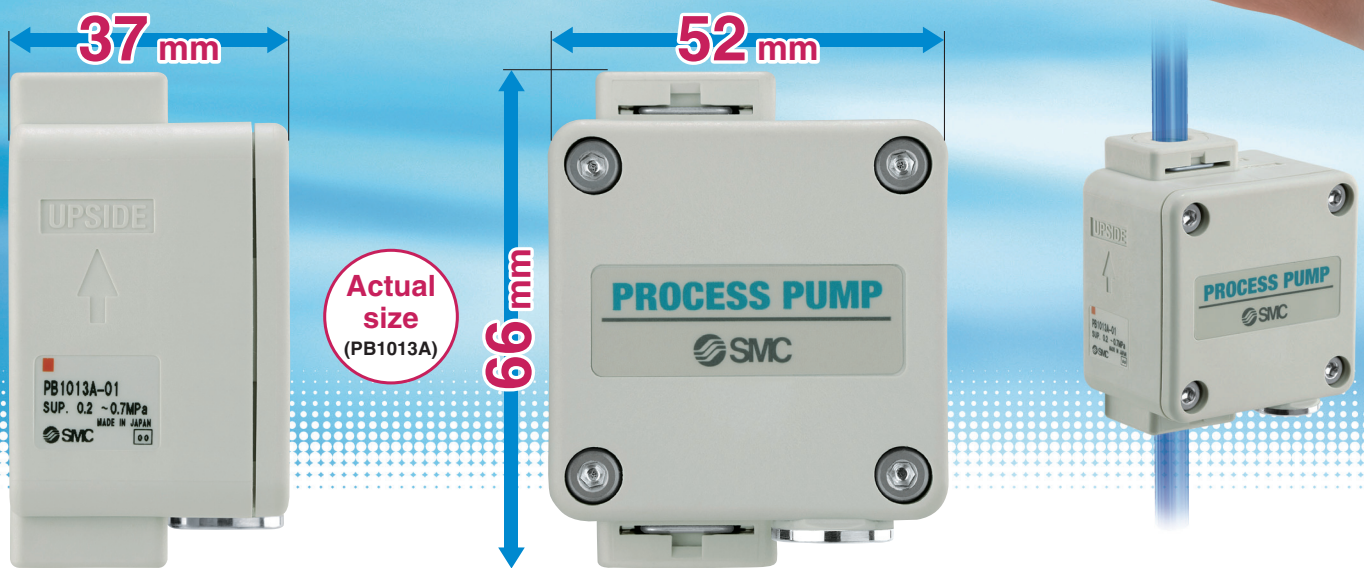

## Space saving (Air operated)

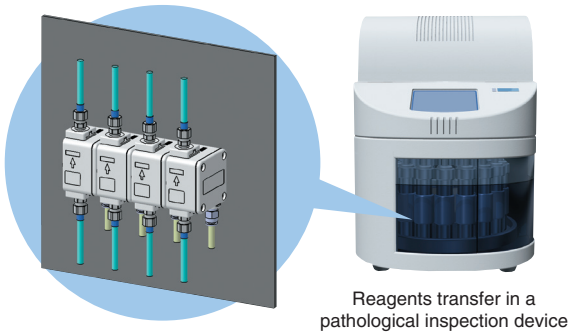

## Application Examples

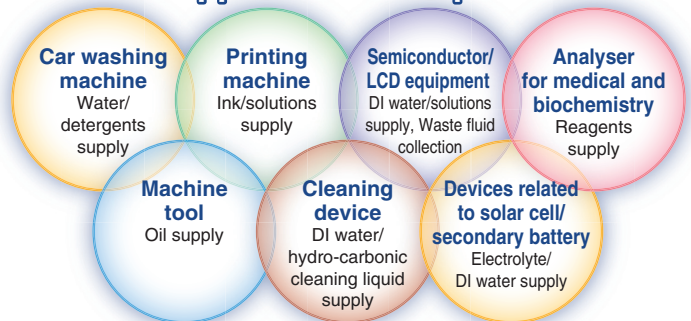

- Low particle generation due to the diaphragm structure
- Flammable fluids can be used. (Air operated)
- Self-priming makes priming unnecessary. Sucks the liquid even if the pump is dry.
- Assembled in a clean room. Double packaged (PB1313A)
- Easy to adjust the flow rate by the frequency of ON/OFF of the solenoid valve.

Body wetted parts: Polypropylene / Stainless steel 316

Wetted materials: Body: New PFA / Diaphragm: PTFE

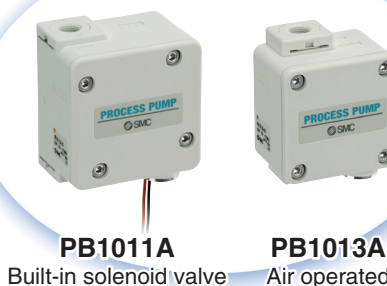

Series **PB**



CAT.EUS100-90A-UK

# Process Pump

## Built-in Solenoid Valve/Air Operated Series PB1000A

### Ease of maintenance improved

Piping connection port can be removed. The check ball can be replaced for maintenance easily.

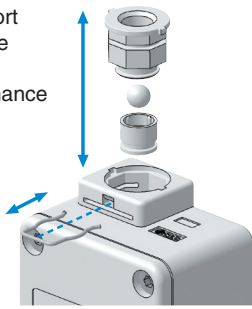

The port can be removed by pulling out the clip.

### Check valve is resistant against foreign matter.

Flow passage around the check ball is enlarged and improved for better resistance against foreign matter.

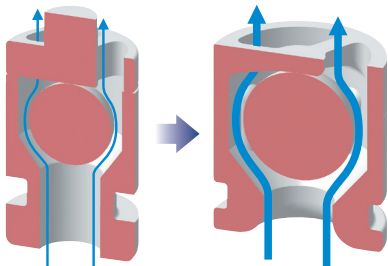

Fluid passage area comparison

**1.5 times** (Comparison with current PB series)

Discharge port  
<FLUID OUT>

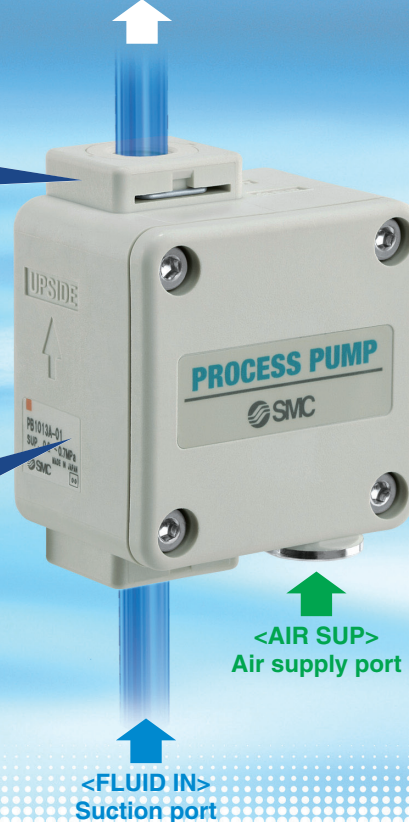

Smaller, lighter, **25%** reduction in volume (Air operated/PB1013A)

Power consumption reduced

0.45 W → **0.35 W**

CE compliant (Built-in solenoid valve/PB1011A)

Longer life [Life is **1.5** times longer than the current product.]

Longer life is realized by changing PTFE diaphragm to modified PTFE with better resistance.

RoHS

### Mounting Variations Note) Mounting orientation: <FLUID OUT> port on top only

#### ■ Front mounting (with foot)

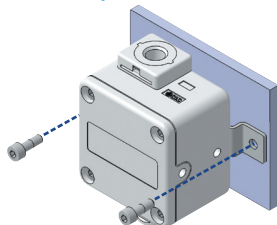

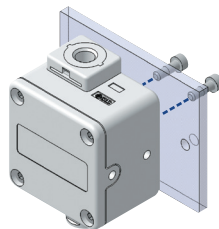

#### ■ Rear mounting

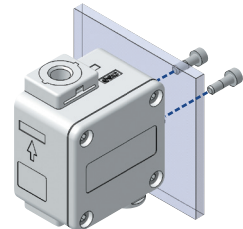

#### ■ Side mounting \* PB1013A only



### Series Variations

Series	Actuation	Discharge (ml/min)	Material				Port size	Made to Order
			Body wetted parts	Diaphragm	Check valve	Liquid contact seals		
 <b>PB1011A</b>	Built-in solenoid valve	8 to 2000	Polypropylene (PP)	PTFE	PTFE PP	FKM	1/8 female thread	—
 <b>PB1013A</b>	Air operated	8 to 1000	Stainless steel (SUS316)	PTFE	PTFE PP	FKM	1/8 female thread	Liquid contact seals SF7000 With bracket which is interchangeable with previous type
 <b>PB1313A</b>	Air operated	8 to 1000	New PFA	PTFE	PTFE New PFA	PTFE	1/8 female thread, 1/4" tube extension, With nut (LQ1/LQ3)	—

Note) Refer to page 14 for applicable fluids.

# Air Operated/Wetted Materials: Fluoropolymer Series PB1313A

## Compact pump for DI water/chemicals

- For transferring and collecting DI water/chemicals\* ● Wetted materials: **Body** New PFA **Diaphragm** PTFE
- \* Refer to page 14 for applicable fluids.
- Assembled in a clean room. Double packaged



### Variation on fittings with nut (PB1313A only)

#### Insert bushing type (LQ1 fittings)

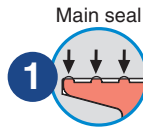

#### Triple seal construction

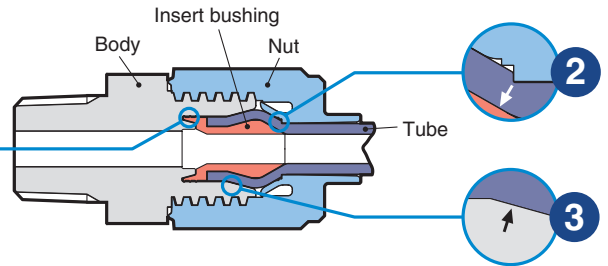

#### Flare type (LQ3 fittings)

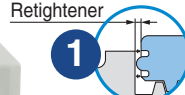

#### Triple seal construction

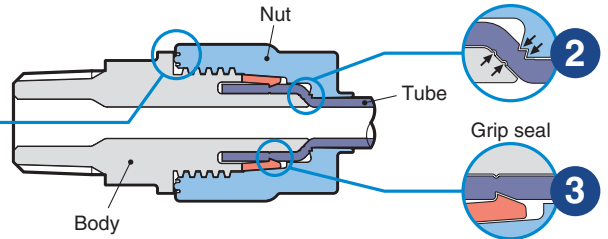

## Application Examples

### Car washing machine

Detergents transfer

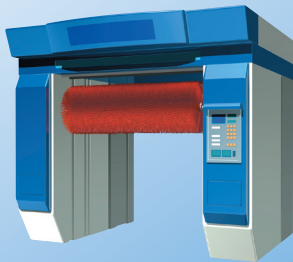

### Printing machine

Head cleaning liquid transfer

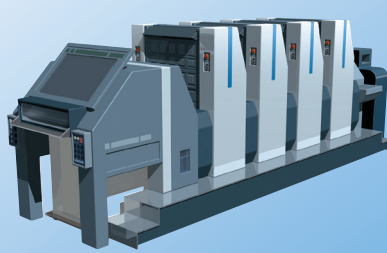

### Machine tool

Coolant liquid collection

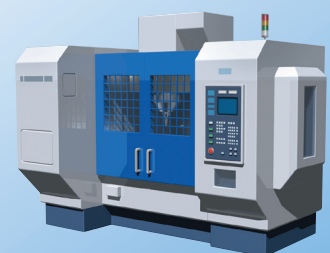

### Analiser (For medical/biochemical industry)

Reagents transfer



### Related to semiconductor/solar cell

Cleaning liquid (e.g. DI water) collection



## Installation Examples

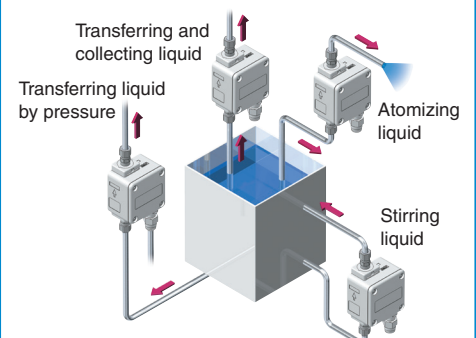

# Process Pump (Diaphragm Pump)

## Body Wetted Parts: Polypropylene/Stainless Steel

## Built-in Solenoid Valve/Air Operated (External switching type)

# Series PB1000A



### How to Order

**Built-in Solenoid Valve  
PB1011A**



**Air Operated  
PB1013A**



**PB101** **1** **A** - **01** - **-** - **-**

**Actuation**

Symbol	Actuation
1	Built-in solenoid valve
3	Air operated

**Thread type**

Symbol	Type
-	Rc
N	NPT
F	G

**Port size**

Symbol	Port size
01	1/8

**Made to Order**

(For details, refer to page 5.)

-	None
X16	Liquid contact seals SF7000
X47	With bracket which is interchangeable with previous type

\* Only PB1013A, air-operated type is available to be made to order.

**Option**

Symbol	Option	Applicable actuation	
		Built-in solenoid valve	Air operated
-	None	●	●
B	With foot	●	●
N	With silencer	●	-

\* When option is more than one, suffix in alphabetical order.

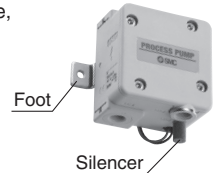

### Specifications

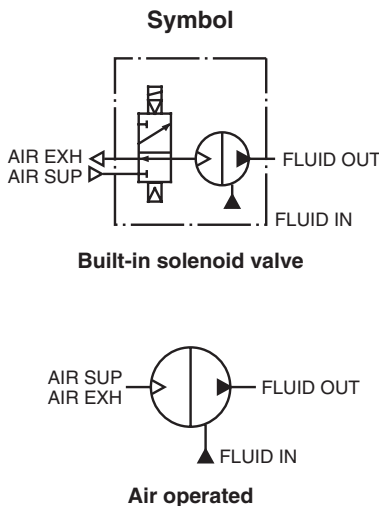

Model		PB1011A	PB1013A
<b>Actuation</b>		Built-in solenoid valve	Air operated
<b>Port size</b>	Main fluid suction/discharge port	Rc, NPT, G 1/8 female thread	
	Pilot air	Supply port	Rc, NPT, G 1/8 female thread
		Exhaust port	M5 x 0.8 female thread
<b>Material</b>	Body wetted parts	Polypropylene (PP), Stainless steel (SUS316)	
	Diaphragm	PTFE	
	Check valve	PTFE, Polypropylene (PP)	
	Liquid contact seals	FKM	
<b>Discharge</b> <sup>Note 1)</sup>		8 to 2000 ml/min	8 to 1000 ml/min <sup>Note 2)</sup>
<b>Average discharge pressure</b>		0 to 0.6 MPa	
<b>Pilot air pressure</b>		0.2 to 0.7 MPa	
<b>Air consumption</b>		40 l/min (ANR) or less	
<b>Suction head</b> <sup>Note 1)</sup>		Up to 2.5 m (dry state inside the pump)	
<b>Noise</b>		64 dB (A) or less (Option: With silencer AN120-M5)	
<b>Withstand pressure</b>		1.05 MPa	
<b>Diaphragm life (Reference)</b>		30 million cycles	
<b>Fluid temperature</b>		0 to 50°C (No freezing, heat cycle not applied)	
<b>Ambient temperature</b>		0 to 50°C (No freezing, heat cycle not applied)	
<b>Recommended operating cycle</b>		1 to 10 Hz	
<b>Pilot air solenoid valve recommended Cv value</b>		-	0.2 <sup>Note 3)</sup>
<b>Weight</b>		0.18 kg	0.11 kg
<b>Mounting orientation</b>		FLUID OUT port upside	
<b>Packaging</b>		General environment	
<b>Maximum viscosity</b>		100 mPa·s	
<b>Power supply voltage</b>		24 VDC	-
<b>Power consumption</b>		0.35 W	-

**Option/Part No.**

Model	PB1011A	PB1013A
Description		
Foot <sup>Note)</sup>	KT-PB1-3	KT-PB1A-5
Silencer	AN120-M5	-

Note) With foot mounting screws (2 pcs.)

\* Each of the values above are for normal temperatures and clean water.

\* For related products, refer to pages 11 to 13.

\* Faulty sealing of the check valves or accumulation of dust may cause operation to stop, so slurry processing is not available.

Note 1) The values given for discharge and suction head are for no piping. Values will depend on piping conditions.

Note 2) Applicable up to 2000 ml/min by using a solenoid valve with a large Cv value (Cv value of 0.5 or more).

Note 3) With low operating cycles, even a valve with a small Cv value can be operated.

## Flow-rate Characteristics

### Built-in Solenoid Valve (PB1011A)

Cycle (1 Hz)

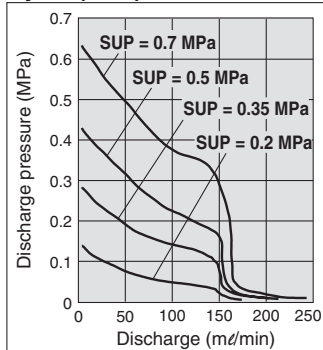

Cycle (5 Hz)

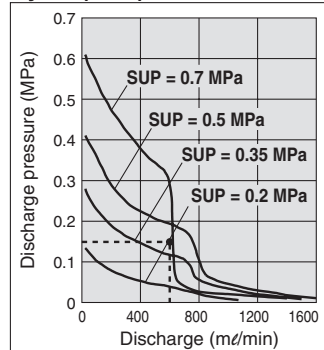

Cycle (7 Hz)

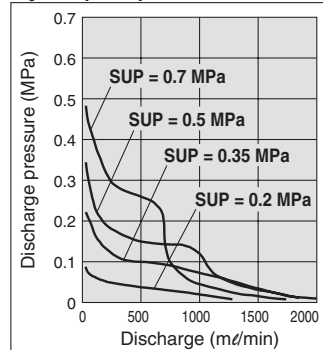

### Air Operated (PB1013A)

Cycle (1 Hz)

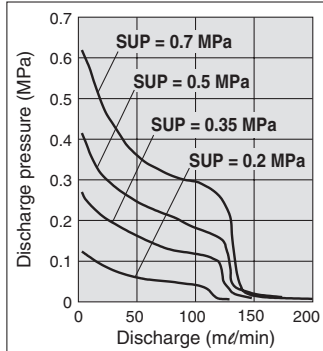

Cycle (5 Hz)

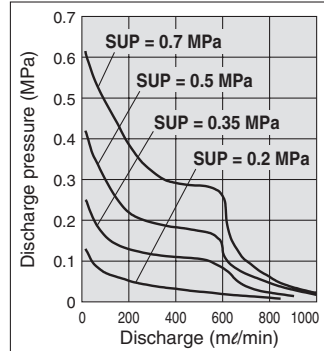

Cycle (7 Hz)

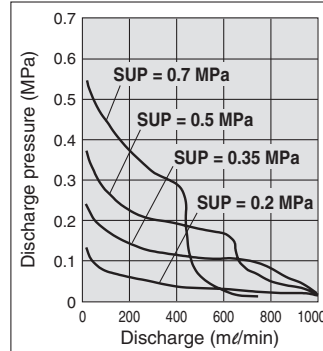

### Selection from Flow-rate Characteristic Graph

■ **Required specification example**

Find the pilot air pressure for a discharge rate of 600 m<sup>3</sup>/min and a discharge pressure of 0.15 MPa for built-in solenoid valve type.

<The transferred fluid is clean water (viscosity of 1 mPa·s, specific gravity of 1.0) and solenoid valve cycle is 5 Hz.>

\* When the total pump head is required instead of the discharge pressure, a discharge pressure of 0.1 MPa corresponds to a total pump head of 10 m.

■ **Selection procedure**

1. First, mark the intersection point for a discharge rate of 600 m<sup>3</sup>/min and a discharge pressure of 0.15 MPa.
2. Find the pilot air pressure for the marked point. In this case, the point is between the discharge curves for 0.35 MPa and 0.5 MPa, and based on the proportional relationship to these lines, the pilot air pressure for

⚠ **Caution**

1. Flow-rate characteristics are for clean water (viscosity of 1 mPa·s, specific gravity of 1.0), no piping for suction and discharge.
2. The amount of discharge differs greatly depending on properties (viscosity, specific gravity) of the fluid being transferred and operating conditions (pump head, transfer distance), etc.

## Air Consumption: Built-in Solenoid Valve/Air Operated

### Air Consumption

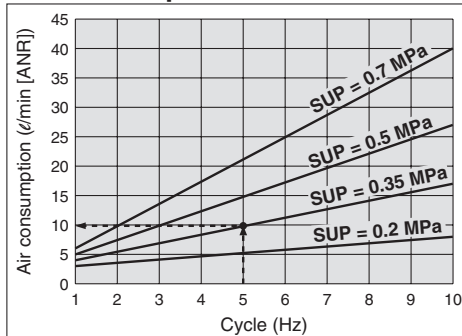

### Calculation of Air Consumption

Find the air consumption for operation with a 5 Hz switching cycle and pilot air pressure of 0.35 MPa from the air consumption graph.

■ **Selection procedure**

1. Look up from the 5 Hz switching cycle to find the intersection with SUP = 0.35 MPa.
2. From the point just found, draw a line to the Y-axis to find the air consumption. The result is approximately 10 l/min (ANR).

⚠ **Caution**

1. The air consumption differs greatly depending on properties (viscosity, specific gravity) of the transferred fluid and operating conditions (pump head, transfer distance), etc.

## Viscosity Characteristics: Built-in Solenoid Valve/Air Operated

### Viscosity Characteristics

(Flow rate correction for viscous fluids)

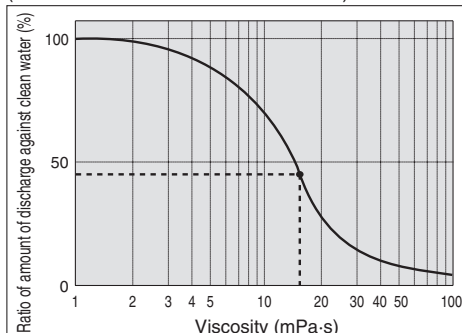

### Selection from Viscosity Characteristic Graph

■ **Required specification example**

Find the pilot air pressure and pilot air consumption for a discharge rate of 270 m<sup>3</sup>/min, discharge pressure of 0.15 MPa, and a viscosity of 15 mPa·s.

■ **Selection procedure**

1. First, find the ratio of the amount of discharge against clean water when viscosity is 15 mPa·s from the graph to the left. It is determined to be 45%.
2. Next, the viscosity of 15 mPa·s and the discharge rate of 270 m<sup>3</sup>/min in the required specification example are converted to the amount of discharge for clear water. Since 45% of the clear water discharge is equivalent to 270 m<sup>3</sup>/min in the required specifications, 270 m<sup>3</sup>/min × 0.45 = approximately 600 m<sup>3</sup>/min, indicating that a discharge rate of 600 m<sup>3</sup>/min is required for clean water.
3. Finally, find the pilot air pressure and pilot air consumption based on the flow-rate characteristic graphs.

■ **Viscosity**

Transfer is possible up to about 100 mPa·s.

**Kinematic viscosity  $\nu$  = Viscosity  $\mu$ /Density  $\rho$**

$$\nu = \frac{\mu}{\rho} \quad \nu(10^{-3} \text{m}^2/\text{s}) = \mu(\text{mPa}\cdot\text{s})/\rho(\text{kg}/\text{m}^3)$$

# Series PB1000A

## Working Principle: Built-in Solenoid Valve/Air Operated

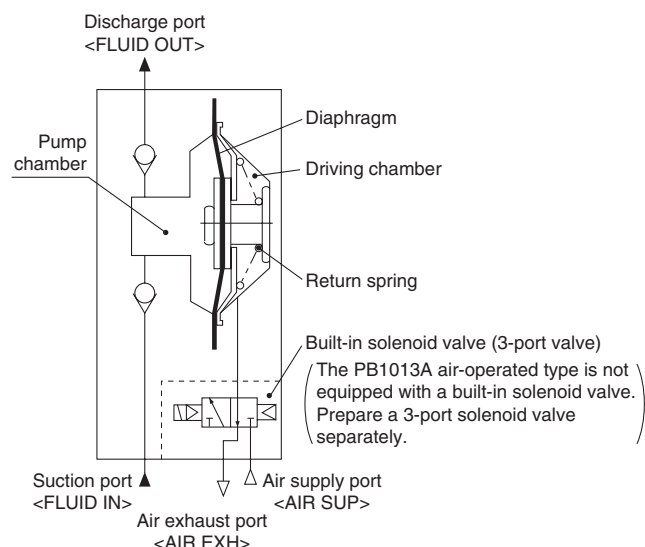

When air is supplied with the built-in solenoid valve turned ON (energized), air enters the driving chamber and the diaphragm moves to the left. Due to this movement, the fluid in the pump chamber passes through the upper check valve and is discharged to the discharge port <FLUID OUT>.

When the solenoid valve is turned OFF (de-energized), the air inside the driving chamber is evacuated to air exhaust port <AIR EXH>, and the diaphragm is moved to the right by the return force of the return spring. Due to this movement, the fluid on the suction port <FLUID IN> passes through the check valve and is sucked into the pump chamber.

The PB1011A transfers the fluid continuously by suction and discharge in turn by repeating ON/OFF of the built-in solenoid valve. The PB1013A air-operated type is operated by the ON/OFF operation of an external solenoid valve.

## Piping and Operation: Built-in Solenoid Valve/Air Operated

### Piping diagram

#### PB1011A

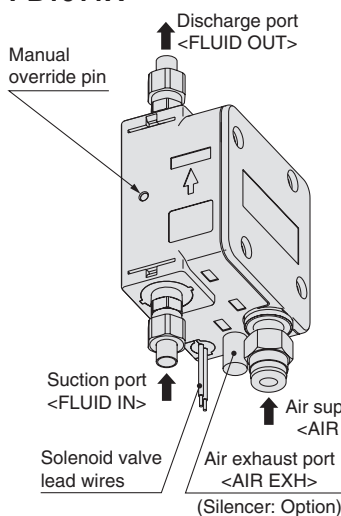

#### PB1013A

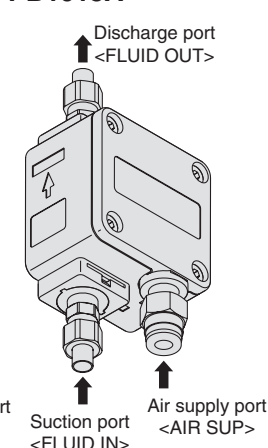

### ⚠ Caution

Be sure that the discharge port <FLUID OUT> is on top when the pump is mounted. Supply clean air that has passed through a filter or mist separator, etc., to the air supply port <AIR SUP>. Air that contains debris or drainage, etc., will have an adverse effect on the built-in solenoid valve, and will cause malfunction of the pump.

Maintain the proper tightening torque for fittings or mounting bolts. Looseness can cause problems such as liquid or air leakage, while over-tightening can cause damage to threads or parts, etc.

### Operation

1. Connect air piping to the air supply port <AIR SUP>, and connect piping for transferred fluid to the suction port <FLUID IN> and the discharge port <FLUID OUT>.
2. Connect the solenoid valve lead wires to a 24 VDC power supply. Red is (+) and Black is (-). (The PB1013A air-operated type must be equipped with a separate 3-port solenoid valve.)
3. Using a regulator, set the pilot air pressure within the range of 0.2 to 0.7 MPa. By continuously turning the 24 VDC power ON/OFF, the fluid flows from the suction port <FLUID IN> to the discharge port <FLUID OUT>. The pump performs suction with its own power even without priming. Idle run of the pump shall be 3 minutes or less for the intake of the liquid.
4. To stop the pump turn OFF the 24 VDC power. Also, be sure to turn OFF the power when the discharge side is closed. If the pump is stopped for a long time, exhaust the air from the <AIR SUP> port. The manual override pin is used for manual operation when there is no electric power. Each time it is pressed, there is one reciprocal operation.

For the PB1013A air-operated type, stop the 3-port solenoid valve to discharge air from the pump. Although the pump can be stopped by closing the valve installed in the discharge side, avoid stopping operation for a long time. If the valve opens/closes suddenly, surge is generated, shortening the pump life. When the tank for fluid suction side is empty, stop operating the pump immediately.

### Recommended Valve (Air operated)

PB1013A	SYJ5□4
---------	--------

### Circuit example/Built-in solenoid valve

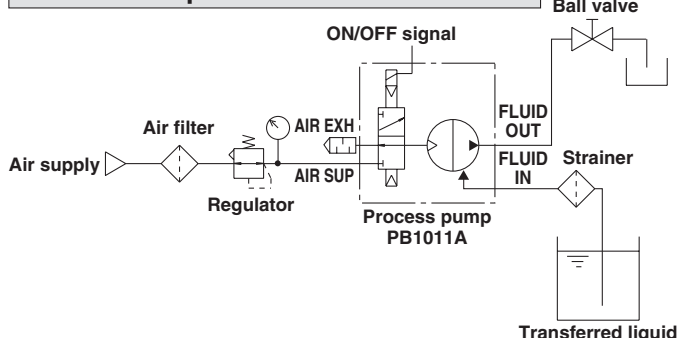

### Circuit example/Air operated

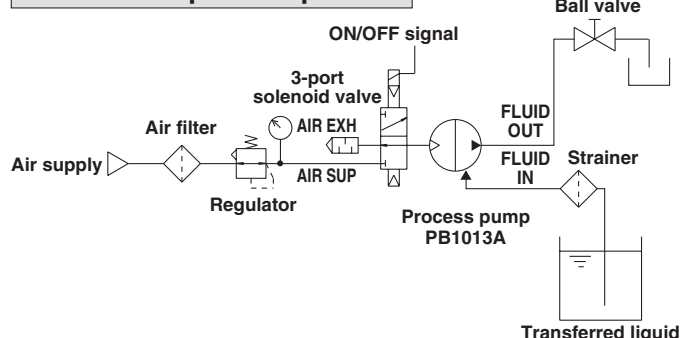

## Dimensions

### Built-in Solenoid Valve PB1011A

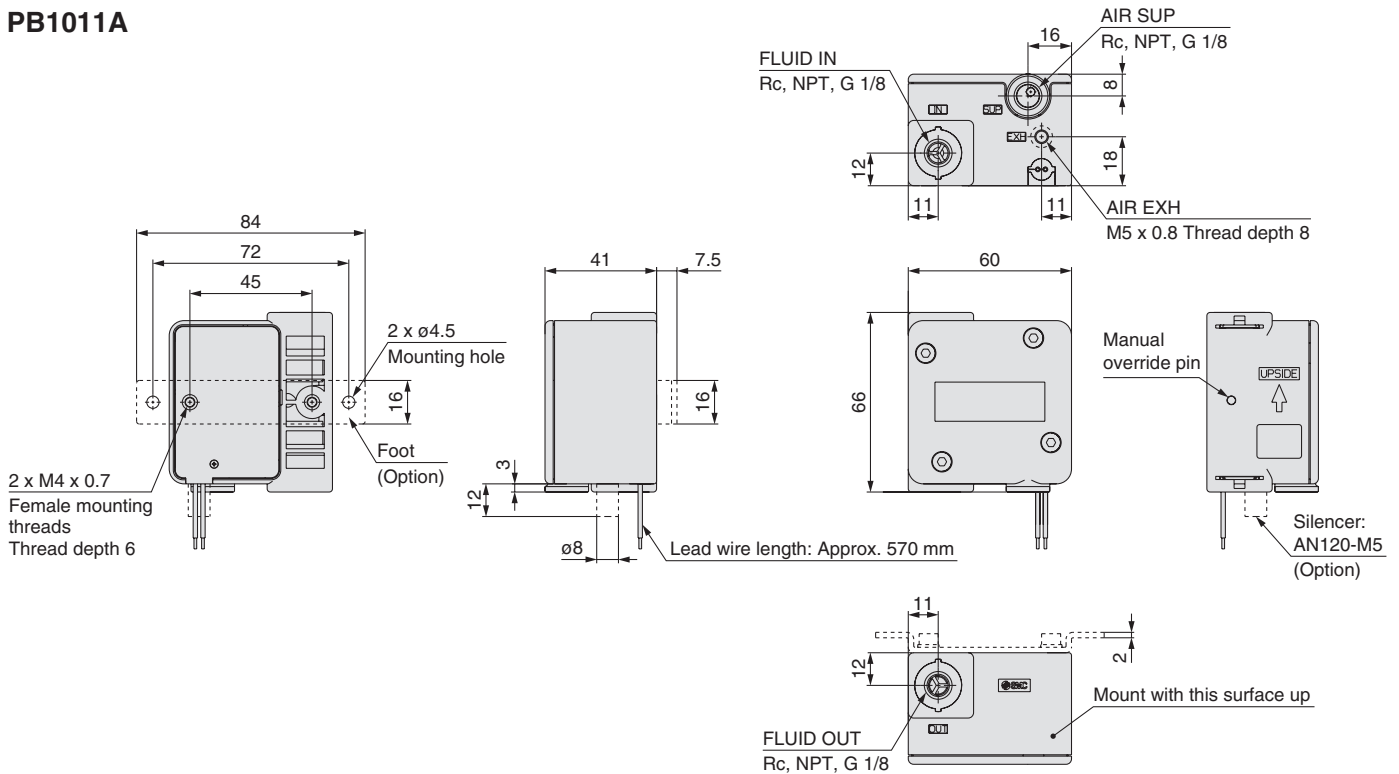

### Air Operated PB1013A

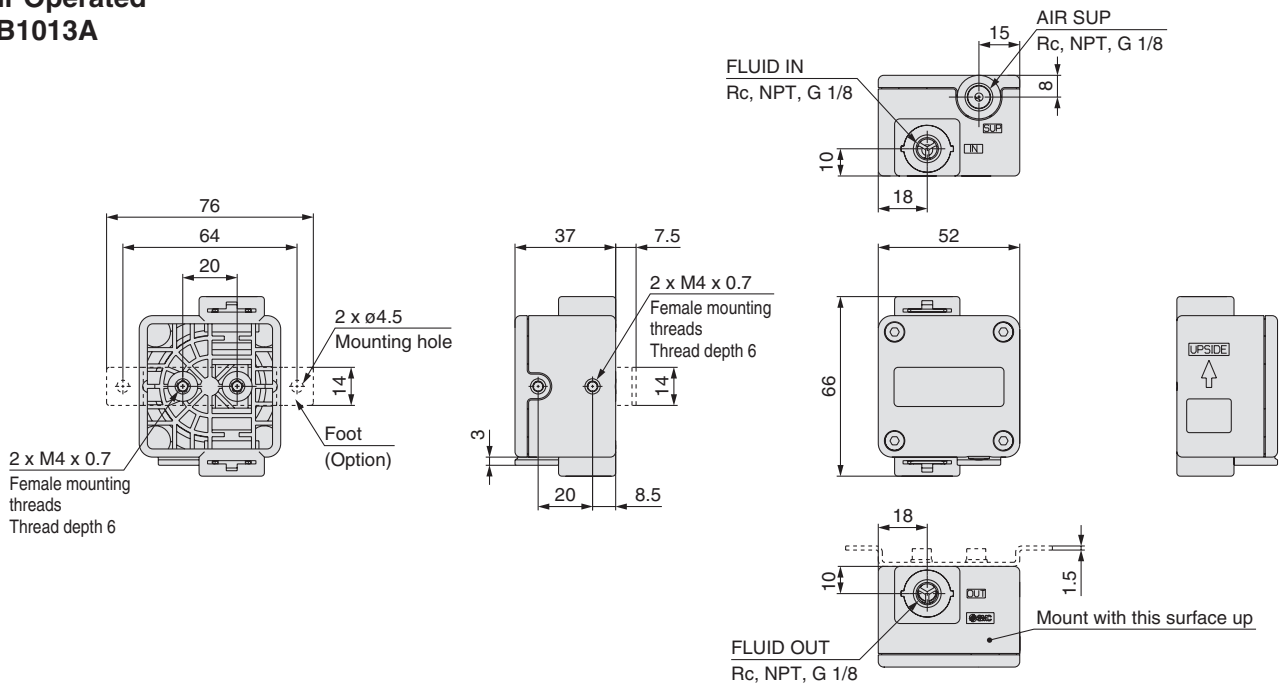

## ⚠ Caution

### 1. Check the mounting orientation of the product.

Mount the product vertically so that the <FLUID OUT> port faces upward.

Also, secure all specified mounting positions when using the product. If the propagation of the vibration of the pump is not acceptable, insert vibro-isolating rubber when mounting.

# Series PB1000A

## Made to Order

Please contact SMC for detailed dimensions, specifications and lead times.



### 1 Liquid contact seals SF7000 (Perfluoropolyether rubber) X16

PB1013A-□01-□-X16

**Actuation**

Symbol	Actuation
3	Air operated

**Thread type**

Symbol	Type
—	Rc
N	NPT
F	G

**Made to Order**

X16	Liquid contact seals SF7000
-----	-----------------------------

**Option**

Symbol	Option
—	None
B	With foot

Seal material of the liquid contact parts is changed to SF7000 (Perfluoropolyether rubber). Has better resistance against chemicals.

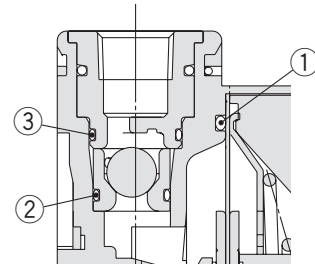

①-③: O-rings (SF7000)

### 2 With bracket which is interchangeable with previous type X47

Bracket which is interchangeable with previous PB1000 series is mounted.

PB1013A-□01-C-X47

**Actuation**

Symbol	Actuation
3	Air operated

**Thread type**

Symbol	Type
—	Rc
N	NPT
F	G

**Made to Order**

X47	With bracket which is interchangeable with previous type
-----	--

**Interchangeable bracket type**

Symbol	Interchangeable bracket type
C	With bracket which can be mounted to the back of the previous type
F	With bracket which can be mounted to the foot at the back of the previous type

With bracket which can be mounted to the back of the previous type: C

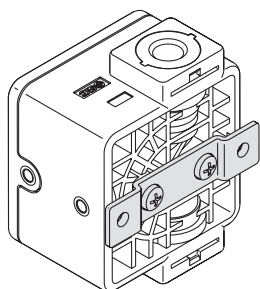
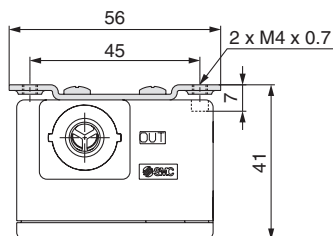

With bracket which can be mounted to the foot at the back of the previous type: F

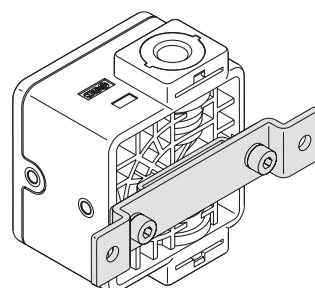
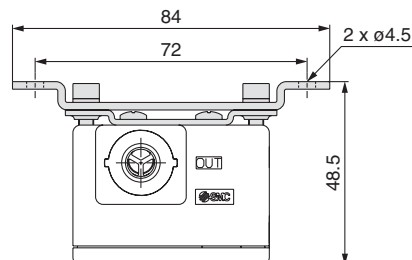

# Process Pump (Diaphragm Pump)

## Wetted Materials: Fluoropolymer

## Air Operated (External switching type)

# Series PB1313A

RoHS

### How to Order

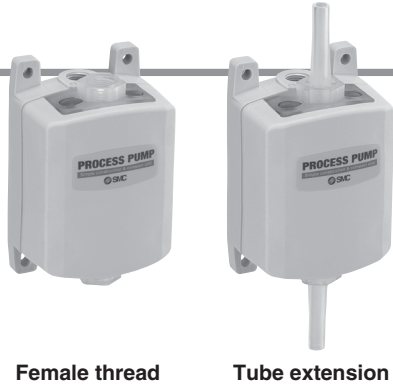

Female thread

Tube extension

Actuation	
Symbol	Actuation
3	Air operated

Diaphragm material	
Symbol	Material
1	PTFE

#### Port size

Symbol	Main fluid connection size	Connection size in the air side
--------	----------------------------	---------------------------------

Female thread		
01		Rc1/8
N01		NPT1/8
F01		G1/8

Tube extension		
P07	1/4" tube extension	Rc1/8
P07N		NPT1/8
P07F		G1/8

Female thread/  
Tube extension

PB13 1 3 A - P07

With nut\*

PB13 1 3 A S -

\* The pump with nut is recommended when SMC fitting, LQ series, is used.

Connection method	
Symbol	Connection method
S	With nut (Note)

Note) Refer to page 7 for details of the connection of the nut.

#### Port size

Symbol	Main fluid connection size	Connection size in the air side
--------	----------------------------	---------------------------------

With nut		
1S07	With LQ1 size 2 nut	Rc1/8
1S07N		NPT1/8
1S07F		G1/8
3S07	With LQ3 size 2 nut	Rc1/8
3S07N		NPT1/8
3S07F		G1/8



With nut  
(LQ1 fittings)

With nut  
(LQ3 fittings)

### Specifications

Model		PB1313A
<b>Actuation</b>		Air operated
<b>Port size</b>	Main fluid suction/discharge port	Rc, NPT, G 1/8 female thread, 1/4" tube extension, With nut (LQ1/LQ3)
	Pilot air supply/exhaust port	Rc, NPT, G 1/8 female thread
<b>Material</b>	Body wetted parts	New PFA
	Diaphragm	PTFE
	Check valve	PTFE, New PFA
	Liquid contact seals	PTFE
<b>Discharge</b> (Note 1)		8 to 1000 ml/min
<b>Average discharge pressure</b>		0 to 0.4 MPa
<b>Pilot air pressure</b>		0.2 to 0.5 MPa
<b>Air consumption</b>		15 l/min (ANR) or less
<b>Suction head</b> (Note 1)		Up to 0.5 m
<b>Noise</b>		71 dB (A) or less
<b>Withstand pressure</b>		0.75 MPa
<b>Diaphragm life (Reference)</b>		50 million cycles
<b>Fluid temperature</b>		0 to 50°C (No freezing, heat cycle not applied)
<b>Ambient temperature</b>		0 to 50°C (No freezing, heat cycle not applied)
<b>Recommended operating cycle</b>		1 to 5 Hz
<b>Pilot air solenoid valve recommended Cv value</b>		0.2 (Note 2)
<b>Weight</b>		0.3 kg
<b>Mounting orientation</b>		FLUID OUT port upside
<b>Packaging</b>		Double clean package
<b>Maximum viscosity</b>		100 mPa·s

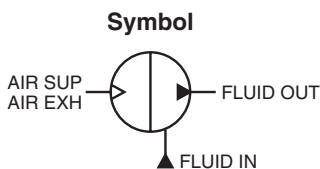

\* Each of the values above are for normal temperatures and clean water.

\* For related products, refer to page 11 to 13.

\* Faulty sealing of the check valves or accumulation of dust may cause operation to stop, so slurry processing is not available.

Note 1) The values given for discharge and suction head are for no piping. Values will depend on piping conditions.

Note 2) With low operating cycles, even a valve with a small Cv value can be operated.

# Series PB1313A

## How to Order Fittings for Products with Nut (PB1313AS)

Fittings compatible for the process pump with nut/PB1313AS.

Product without nut (insert bushing), 1 piece nut removed, which is not necessary in cases when using the products with nut.

### LQ1 fittings

**LQ1 E 21 - SN**

Fitting type

Nut (including insert bushing), 1 location removed

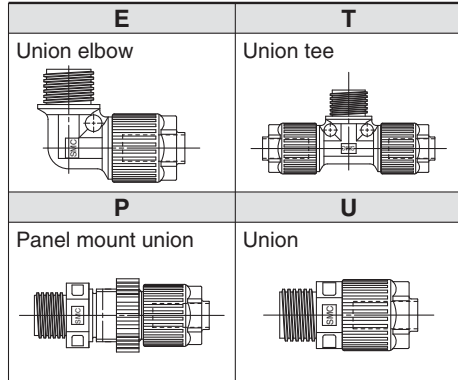

Applicable tube size

Metric

Size	No.	Applicable tube size (mm)	Reducing*
2	1	6 x 4	○
2	2	4 x 3	●

\* ○: Basic size ●: With reducer

Inch

Size	Symbol	Applicable tube (inch)	Reducing*
2	A	1/4" x 5/32"	○
2	B	3/16" x 1/8"	●
2	C	1/8" x 0.086"	○

\* ○: Basic size ●: With reducer



Note) Check the IN/OUT side fitting size and fitting type for selecting the fitting.

### LQ3 fittings

**LQ3 E 2A - SN**

Fitting type

Nut, 1 location removed

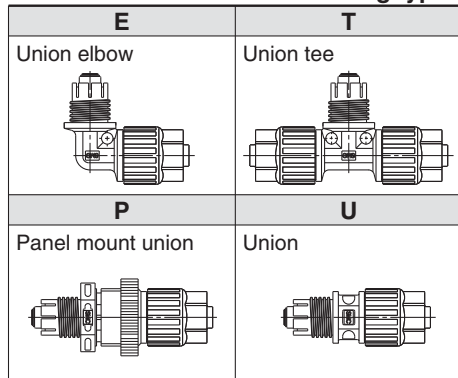

Applicable tube size

Size	Symbol	Applicable tube size (inch)
2	A	1/4" x 5/32"



Note) Check the IN/OUT side fitting size and fitting type for selecting the fitting.

### ⚠ Caution

- For detailed specifications and Specific Product Precautions about fittings (LQ1, LQ3), refer to "Best Pneumatics No. 7."
- Refer to the pamphlet "High-Purity Fluoropolymer Fittings HYPER FITTING/Series LQ1, 2 Work Procedure Instructions" (M-E05-1) or "High Purity Fluoropolymer Fittings Hyper Fitting/Flare Type Series LQ3 Fitting Procedure" (M-E06-4) for connecting tube. (Downloadable from our website.)

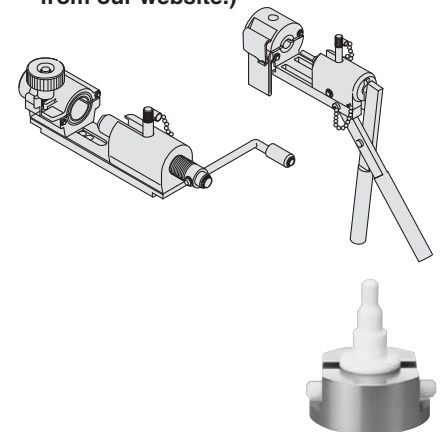

### Ordering Example

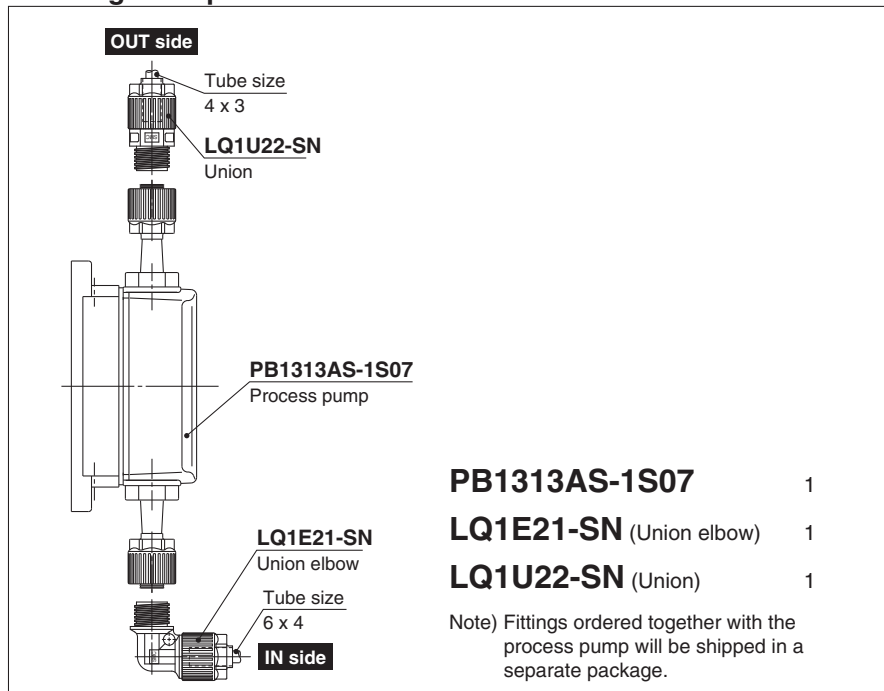

## Flow-rate Characteristics: Air Operated (PB1313A)

### Cycle (1 Hz)

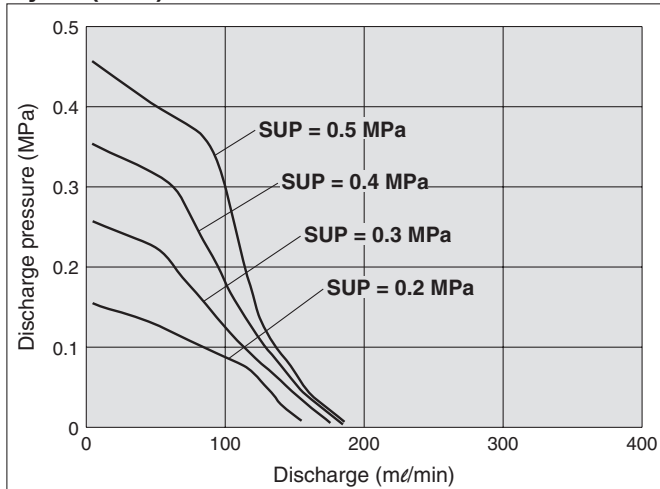

### Cycle (5 Hz)

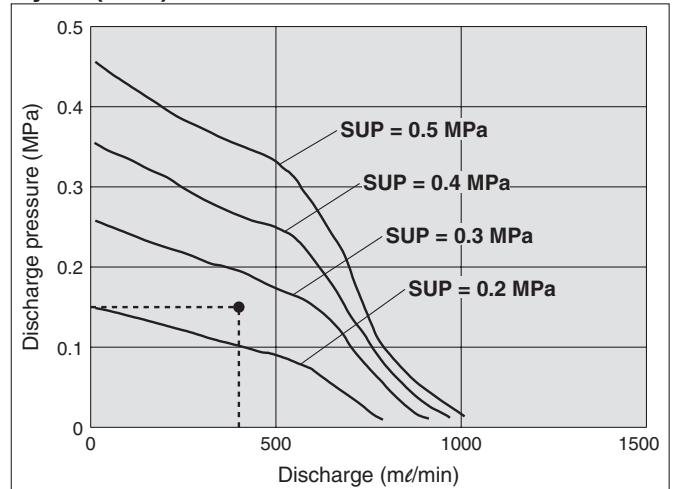

### Air Consumption

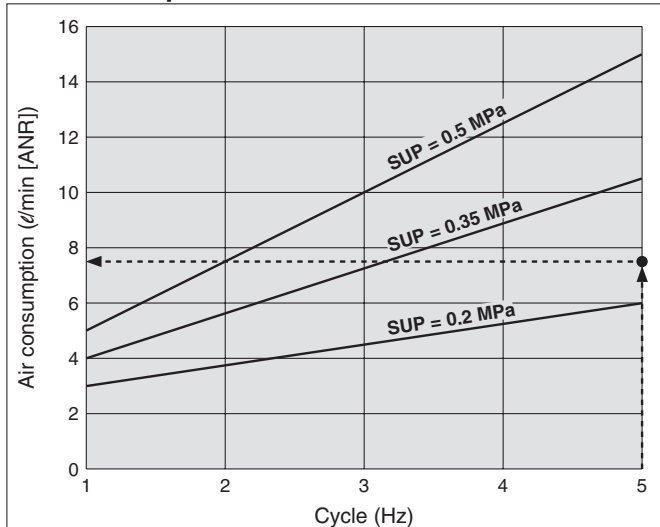

### Selection from Flow-rate Characteristic Graph

#### ■ Required specification example

Find the pilot air pressure for a discharge rate of 400 ml/min and a discharge pressure of 0.15 MPa.

<The transferred fluid is clean water (viscosity 1 mPa-s, specific gravity of 1.0) and solenoid valve cycle is 5 Hz.>

\* When the total pump head is required instead of the discharge pressure, a discharge pressure of 0.1 MPa corresponds to a total pump head of 10 m.

#### ■ Selection procedure

1. First, mark the intersection point for a discharge rate of 400 ml/min and a discharge pressure of 0.15 MPa.
2. Find the pilot air pressure for the marked point. In this case, the point is between the discharge curves for 0.2 MPa and 0.3 MPa, and based on the proportional relationship to these lines, the pilot air pressure for this point is approximately 0.25 MPa.

### Calculation of Air Consumption

Find the air consumption for operation with a 5 Hz switching cycle and pilot air pressure of 0.25 MPa from the air consumption graph.

#### ■ Selection procedure

1. Look up from the 5 Hz switching cycle to find the intersection with SUP = 0.25 MPa.
2. From the point just found, draw a line to the Y-axis to find the air consumption. The result is approximately 7.5 l/min (ANR).

### ⚠ Caution

1. Flow-rate characteristics are for clean water (viscosity of 1 mPa-s, specific gravity of 1.0).
2. The amount of discharge differs greatly depending on properties (viscosity, specific gravity) of the transferred fluid and operating conditions (pump head, transfer distance), etc.

### Selection from Viscosity Characteristic Graph

#### ■ Required specification example

Find the pilot air pressure and pilot air consumption for a discharge rate of 180 ml/min, discharge pressure of 0.15 MPa, and a viscosity of 15 mPa-s.

#### ■ Selection procedure

1. First, find the ratio of the amount of discharge against clear water when viscosity is 15 mPa-s from the graph to the left. It is determined to be 45%.
2. Next, the viscosity of 15 mPa-s and the discharge rate of 180 ml/min in the required specification example are converted to the discharge rate for clear water. Since 45% of the amount of clear water discharge is equivalent to 180 ml/min in the required specifications,  $180 \text{ ml/min} \div 0.45 =$  approximately 400 ml/min, indicating that a discharge rate of 400 ml/min is required for clean water.
3. Finally, find the pilot air pressure and pilot air consumption based on the flow-rate characteristic graphs.

#### ■ Viscosity

Transfer is possible up to about 100 mPa-s.

$$\text{Kinematic viscosity } \nu = \frac{\text{Viscosity } \mu}{\text{Density } \rho}$$

$$\nu = \frac{\mu}{\rho} \quad \nu(10^{-3} \text{m}^2/\text{s}) = \mu(\text{mPa}\cdot\text{s})/\rho(\text{kg}/\text{m}^3)$$

### Viscosity Characteristics (Flow rate correction for viscous fluids)

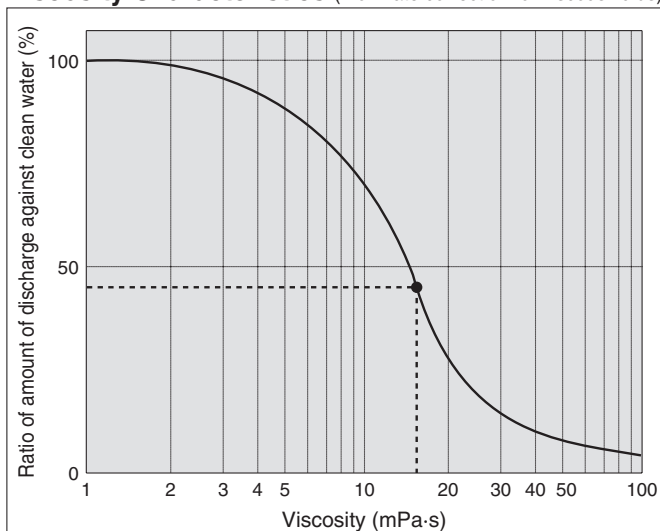

# Series PB1313A

## Working Principle: Air Operated

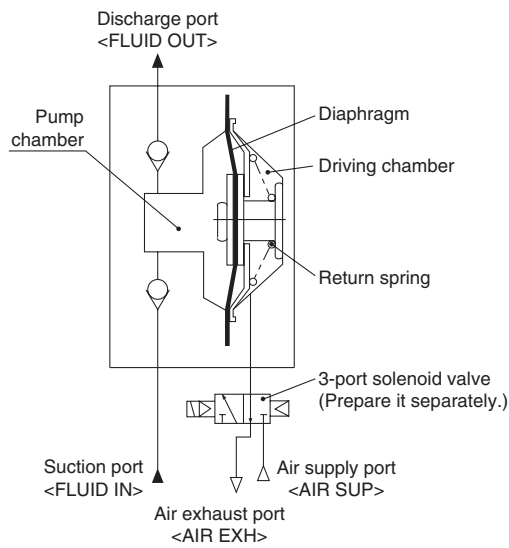

When air is supplied with the external 3-port solenoid valve turned ON (energized), air enters the driving chamber and the diaphragm moves to the left. Due to this movement, the fluid in the pump chamber passes through the upper check valve and is discharged to the discharge port <FLUID OUT>.

When the solenoid valve is turned OFF (de-energized), the air inside the driving chamber is evacuated to air exhaust port <AIR EXH>, and the diaphragm is moved to the right by the return force of the return spring. Due to this movement, the fluid on the suction port <FLUID IN> passes through the check valve and is sucked into the pump chamber.

The fluid is transferred continuously by suction and discharge in turn by repeating ON/OFF of the built-in solenoid valve.

## Piping and Operation: Air Operated

### Piping diagram

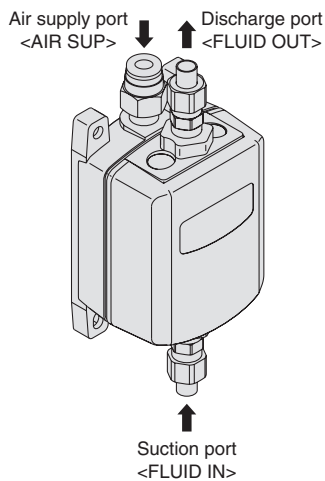

### ⚠ Caution

Be sure that the discharge port <FLUID OUT> is on top when the pump is mounted. Supply clean air that has passed through a mist separator etc., to the air supply port <AIR SUP>. When air needs additional purification, use a mist separator (AM series) and a micro mist separator (AMD series) together. Maintain the proper tightening torque for fittings or mounting bolts. Looseness can cause problems such as liquid or air leakage, while over-tightening can cause damage to threads or parts, etc.

### Operation

1. Connect air piping to the air supply port <AIR SUP>, and connect piping for transferred fluid to the suction port <FLUID IN> and the discharge port <FLUID OUT>.
2. Set the pilot air pressure within the range of 0.2 to 0.5 MPa. If air is supplied or discharged intermittently using a 3-port solenoid valve, the pump operates, then after a short time the fluid flows from suction port <FLUID IN> to the discharge port <FLUID OUT>. The pump performs suction with its own power even without priming. Idle run of the pump shall be 3 minutes or less for the intake of the liquid.
3. To stop the pump, stop the 3-port solenoid valve to discharge air from the pump. Although the pump can be stopped by closing the valve installed in the discharge side, avoid stopping operation for a long time. If the valve opens/closes suddenly, surge is generated, shortening the pump life. When the tank for fluid suction side is empty, stop operating the pump immediately.

### Recommended Valve (Air operated)

PB1313A	SYJ5□4
---------	--------

### Circuit example/Air operated

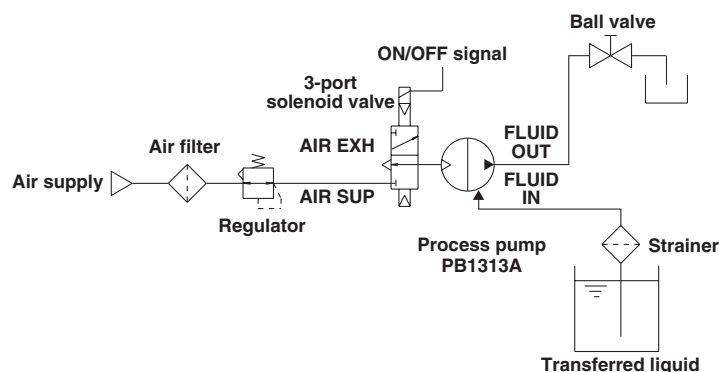

## Dimensions

### Air Operated PB1313A

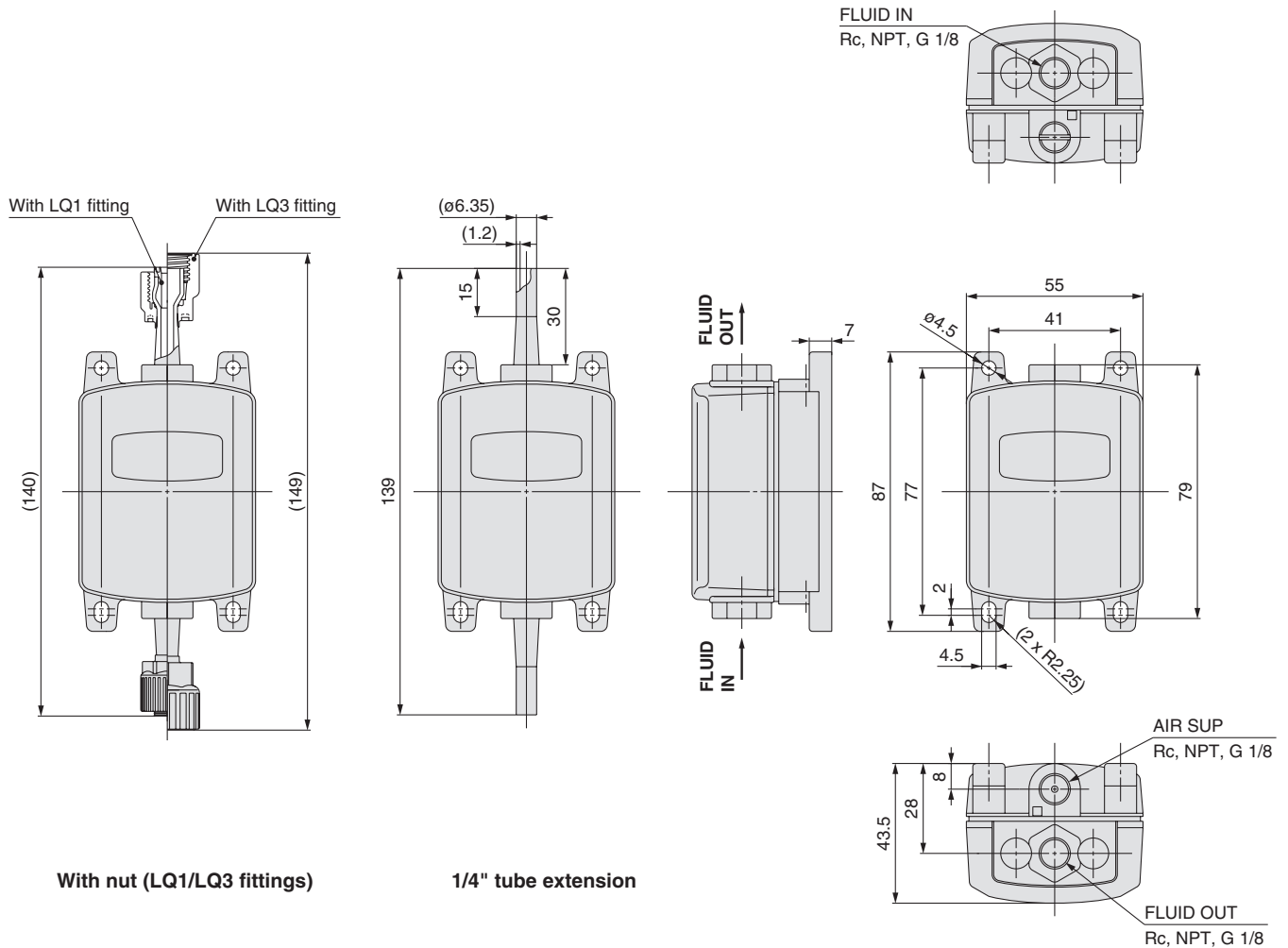

With nut (LQ1/LQ3 fittings)

1/4" tube extension

## ⚠ Caution

### 1. Check the mounting orientation of the product.

Mount the product vertically so that the <FLUID OUT> port faces upward.

Also, secure all specified mounting positions when using the product. If the propagation of the vibration of the pump is not acceptable, insert vibro-isolating rubber when mounting.

### 2. Open the sealed package inside a clean room.

Products specified for clean room (PB1313A) are sealed and double packaged inside a clean room. We recommend that the inner package should be opened inside a clean room or clean environment.

# Series PB Related Products 1

## 3 Port Solenoid Valve SYJ314/514/714

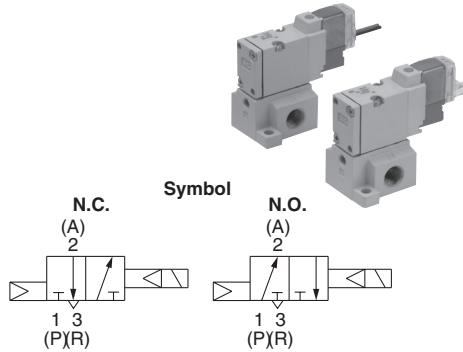

### Specifications

Model		SYJ314	SYJ514	SYJ714	
Piping		Base mounted			
Valve construction		Rubber seal			
Type of actuation		N.C.			
Maximum operating pressure		0.7 MPa			
Minimum operating pressure		0.15 MPa			
Flow-rate characteristics	1 → 2 (P → A)	C[dm <sup>3</sup> /(s·bar)]	0.41	1.2	2.9
		b	0.18	0.41	0.32
		Cv	0.086	0.32	0.71
	2 → 3 (A → R)	C[dm <sup>3</sup> /(s·bar)]	0.35	1.1	2.7
		b	0.33	0.46	0.34
		Cv	0.086	0.32	0.69

Refer to "Best Pneumatics No. 1" for further details.

## Regulator Series AR



### Model

Model	AR20	AR25	AR30	AR40
Port size	1/8, 1/4	1/4, 3/8	1/4, 3/8	1/4, 3/8, 1/2
Pressure gauge port size	1/8		1/4	

Refer to "Best Pneumatics No. 5" for further details.

### Specifications

Model	AR20	AR25	AR30	AR40
Proof pressure	1.5 MPa			
Max. operating pressure	1.0 MPa			
Set pressure range	0.05 to 0.85 MPa			
Ambient and fluid temperature <sup>Note</sup>	-5 to 60°C (No freezing)			
Construction	Relieving type			
Weight (kg)	0.21	0.26	0.29	0.44

Note) -5 to 50°C for the regulator with digital pressure switch

## Mist Separator Series AM

Series AM can separate and remove oil mist and remove fine particles such as rust or carbon of 0.3 μm or larger.



### Model

Model	AM150C	AM250C
Rated flow (l/min (ANR))	300	750
Port size (Nominal size B)	1/8, 1/4	1/4, 3/8
Weight (kg)	0.38	0.55

Refer to "Best Pneumatics No. 5" for further details.

### Specifications

Fluid	Compressed air
Max. operating pressure	1.0 MPa
Min. operating pressure <sup>Note 1)</sup>	0.05 MPa
Proof pressure	1.5 MPa
Ambient and fluid temperature	5 to 60°C
Nominal filtration rating	0.3 μm (Filtration efficiency 99.9%)
Downstream oil mist concentration	Max. 1.0 mg/m <sup>3</sup> (ANR) (Approx. 0.8 ppm) <sup>Note 2)</sup>
Element life	When 2 years passed, or pressure drop reaches 0.1 MPa

Note 1) With auto drain is 0.15 MPa

Note 2) When compressor discharge oil mist concentration is 30 mg/m<sup>3</sup> (ANR).

## Micro Mist Separator Series AMD

Series AMD can separate and remove aerosol state oil mist and remove carbon or dust of 0.01 μm or larger.



### Model

Model	AMD150C	AMD250C
Rated flow <sup>Note)</sup> (l/min (ANR))	500	1000
Port size (Nominal size B)	1/4, 3/8	3/8, 1/2
Weight (kg)	0.55	0.9

Note) Maximum flow rate at pressure 0.7 MPa  
Maximum flow rate varies depending on the operating pressure.

Refer to "Best Pneumatics No. 5" for further details.

### Specifications

Fluid	Compressed air
Max. operating pressure	1.0 MPa
Min. operating pressure <sup>Note 1)</sup>	0.05 MPa
Proof pressure	1.5 MPa
Ambient and fluid temperature	5 to 60°C
Nominal filtration rating	0.01 μm (Filtration efficiency 99.9%)
Downstream oil mist concentration	Max. 0.1 mg/m <sup>3</sup> (ANR) <sup>Note 2)</sup> (Before oil saturation, 0.01 mg/m <sup>3</sup> (ANR) or less, approx. 0.008 ppm)
Element life	When 2 years passed, or pressure drop reaches 0.1 MPa

Note 1) With auto drain is 0.1 MPa (N.O. type), 0.15 MPa (N.C. type).

Note 2) When compressor discharge oil mist concentration is 30 mg/m<sup>3</sup> (ANR).

**Filter Regulator + Mist Separator  
Air Combination  
Series AC20D/30D/40D**



Model		AC20D	AC30D	AC40D	AC40D-06
Component devices	Filter regulator	AW20	AW30	AW40	AW40-06
	Mist separator	AFM20	AFM30	AFM40	AFM40-06
Port size Rc		1/8 1/4	1/4 3/8	1/4 3/8 1/2	3/4
Pressure gauge port size Rc		1/8	1/8	1/4	1/4

Note 1) Conditions: Upstream pressure 0.7 MPa, set pressure 0.5 MPa. The rated flow rate varies depending on the set pressure.  
Note 2) When compressor discharge concentration is 30 mg/Nm<sup>3</sup>.

Refer to "Best Pneumatics No. 5" for further details.

**Specifications**

Model	AC20D	AC30D	AC40D	AC40D-06
Proof pressure	1.5 MPa			
Max. operating pressure	1.0 MPa			
Min. operating pressure	0.05 MPa			
Set pressure range	0.05 to 0.85 MPa			
Rated flow rate (l/min (ANR)) <sup>Note 1)</sup>	150	330	800	800
Ambient and fluid temperature	-5 to 60°C (No freezing)			
Nominal filtration rating	AW: 5 μm, AFM: 0.3 μm (Filtration efficiency 99.9%)			
Downstream oil mist concentration	Max. 1.0 mg/Nm <sup>3</sup> (Approx. 0.8 ppm) <sup>Note 2)</sup>			
Bowl material	Polycarbonate			
Construction/Filter regulator	Relieving type			
Weight (kg)	0.57	0.74	1.38	1.43

**Water Separator  
Series AMG**

Series AMG can remove droplets of water from compressed air. Use it when it is necessary to remove water, but when air as dry as that from an air dryer is not necessary.



Model	AMG150C	AMG250C
Rated flow <sup>Note)</sup> (l/min (ANR))	300	750
Port size (Nominal size B)	1/8, 1/4	1/4, 3/8
Weight (kg)	0.38	0.55

Note) Maximum flow rate at pressure 0.7 MPa

Refer to "Best Pneumatics No. 5" for further details.

**Specifications**

Fluid	Compressed air
Max. operating pressure	1.0 MPa
Min. operating pressure <sup>Note)</sup>	0.05 MPa
Proof pressure	1.5 MPa
Ambient and fluid temperature	5 to 60°C
Dehumidification rate	99%
Element service life	When 2 years passed, or pressure drop reaches 0.1 MPa

Note) With auto drain is 0.15 MPa.

**Membrane Air Dryer  
Series IDG**

Macromolecular membrane dryers that act like filters.  
-20°C low dew point just by installing in air pressure line.  
No power supply required



**Standard Specifications/Single Unit (Standard Dew Point -20°C)**

Model	Standard dew point: -20°C					
	IDG5	IDG10	IDG20	IDG30	IDG50	
Range of operating conditions	Fluid					
	Compressed air					
	Inlet air pressure (MPa)	0.3 to 0.85		0.3 to 1.0		
Standard performance conditions	Inlet air temperature (°C) <sup>Note 1)</sup>	-5 to 55		-5 to 50		
	Ambient temperature (°C)	-5 to 55		-5 to 50		
	Outlet air atmospheric pressure dew point (°C)	-20				
Standard performance conditions	Inlet air flow rate (l/min (ANR)) <sup>Note 2)</sup>	62	125	250	375	625
	Outlet air flow rate (l/min (ANR))	50	100	200	300	500
	Purge air flow rate (l/min (ANR)) <sup>Note 3)</sup>	12	25	50	75	125
	Inlet air pressure (MPa)	0.7				
	Inlet air temperature (°C)	25				
	Inlet air saturation temperature (°C)	25				
	Ambient temperature (°C)	25				
Dew point indicator purge air flow rate	1 l/min (ANR)					
Port size (Nominal size B)	1/8, 1/4		1/4, 3/8			
Weight (kg) (with bracket)	0.25	0.43	0.66	0.74	0.77	
	(0.31)	(0.51)	(0.76)	(0.87)	(0.90)	

Note 1) No freezing

Note 2) ANR represents the flow rate converted to the value under 20°C at atmospheric pressure.

Note 3) Including the dew point indicator purge air flow rate of 1 l/min (ANR) (inlet air pressure at 0.7 MPa) (Except IDG1, IDG5)

Refer to "Best Pneumatics No. 5" for further details.

**Strainer  
P257014A**

Strainer for the collection of fluids



**Application example**

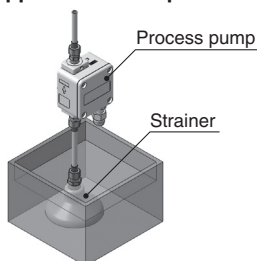

**Specifications**

Part no.	<b>P257014A</b>
Fluid	Cutting oil
Applicable tube O.D./I.D.	ø6/ø4.5
Nominal filtration rating	60 mesh wire
Material	Cast iron/Electroless Ni-P alloy plating
Weight (kg)	0.2

Refer to "Best Pneumatics No. 4" (HEP500-04) for further details.

# Series PB Related Products 2

## High Purity Chemical Valves Series LV

 Refer to "Best Pneumatics No. 7" for further details.

Air operated  
Integral fitting type  
Series LVC

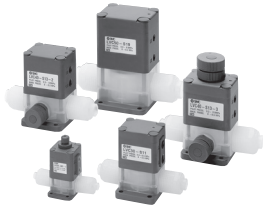

Air operated  
Threaded type  
Series LVA



Manually operated  
Integral fitting type/  
Threaded type  
Series LVH



Air operated  
Compact type  
Series LVD

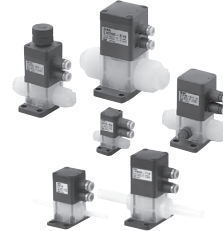

Air operated/  
Manually operated  
Non-metallic exterior  
Series LVQ



## Fluoropolymer Fittings Hyper Fitting Series LQ1

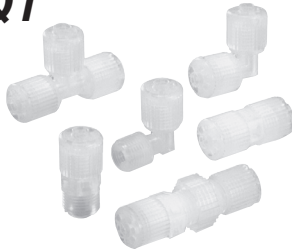

### Specifications

Model		LQ1□10	LQ1□20	LQ1□30
Material		New PFA		
Max. operating pressure (at 20°C)		1.0 MPa		
Operating temperature		0 to 200°C		
Applicable tube size	Metric	ø3 to ø25		
	Inch	1/8" to 1"		

 Refer to "Best Pneumatics No. 7" for further details.

## Fluoropolymer Fittings Hyper Fitting/Flare type Series LQ3

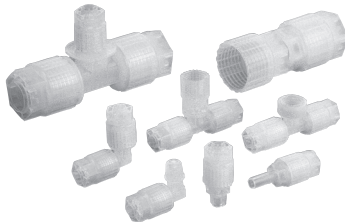

### Specifications

Model		LQ3□10	LQ3□20	LQ3□30
Material		New PFA		
Max. operating pressure (at 20°C)		1.0 MPa		
Operating temperature	Nut material: PVDF	0 to 150°C		
	Nut material: PFA	0 to 200°C		
Applicable tube size	Metric	ø3 to ø25		
	Inch	1/8" to 1 1/4"		

 Refer to "Best Pneumatics No. 7" for further details.

## Fluoropolymer Needle Valve Series LVN



### Specifications

Model		LVN20	LVN30	LVN40
Orifice diameter		ø4.4	ø8	ø10
Tube size	Metric	4, 6	6, 8, 10	10, 12
	Inch	1/8", 3/16", 1/4"	1/4", 3/8"	3/8", 1/2"

 Refer to "Best Pneumatics No. 7" for further details.

## Fluoropolymer Tubing Series TL/TIL



### Specifications

Model	TL (Metric)					
Tubing model	TL0403	TL0604	TL0806	TL1008	TL1210	TL1916
O.D. x I.D. (Metric)	ø4 x ø3	ø6 x ø4	ø8 x ø6	ø10 x ø8	ø12 x ø10	ø19 x ø16

Model	TIL (Inch)					
Tubing model	TIL01	TILB01	TIL05	TIL07	TIL11	TIL13
Nominal size (Inch)	1/8"	1/8"	3/16"	1/4"	3/8"	1/2"
O.D. x I.D. (Inch)	1/8" x 0.086"	1/8" x 1/16"	3/16" x 1/8"	1/4" x 5/32"	3/8" x 1/4"	1/2" x 3/8"

 Refer to "Best Pneumatics No. 7" for further details.



# Series PB Applicable Fluids

## Material and Fluid Compatibility Check List for Process Pumps

- The data below is prepared based on data provided by the material manufacturers.
- SMC assumes no responsibility for the accuracy of the data or for any damages arising from the data.
- The material and fluid compatibility check list provides reference values as a guide only; therefore SMC does not guarantee the application to our product.

### ⚠ Warning

The PB1011A/Built-in solenoid valve type cannot be used when a flammable fluid is used.

### ⚠ Caution

- Select the wetted materials according to the transfer liquid you use to determine the model.
  - The material of the diaphragm of PB series is PTFE. PTFE is suitable for non-permeating liquids.
- These products are not suitable for medical or food use.
- The applicability may vary depending on additives. Take note also of additives.
- The applicability may vary depending on impurities. Take note also of impurities.
- Examples of transfer liquids are shown below. Since the applicability may vary depending on your operating conditions, be sure to check it by means of experimentation.
- The compatibility is indicated for fluid temperatures specified for the respective products (50°C or less).
- Do not use liquids that will cause the wetted sealant to swell.

### Series PB10□□

Model		PB1011A	PB1013A
Body material		Polypropylene, Stainless steel 316	
Diaphragm material		PTFE	
Examples of applicable liquids	Municipal water		○
	Neutral detergent		○
	Kerosene	×	○
	Oils	×	○
	Ethyl alcohol	×	○ Note 1)
	Thinners		×
	Flammable liquids	×	—
	Acids		×
	Alkalis		×

### Series PB1313A

Model		PB1313A	
Body material		New PFA	
Diaphragm material		PTFE	
Examples of applicable liquids	Water	Municipal water	○
		DI water	○
	Oil	Turbine oil	○
		Cutting oil	○
		Brake oil	○
	Solvent	Flux	○
		Toluene	○ Note 1, 2)
		Methyl ethyl ketone	○ Note 1, 2)
		Acetone	○ Note 1, 2)
		Inert solvent	○
	Ethyl alcohol	○ Note 1, 2)	
	Isopropyl alcohol	○ Note 1, 2)	
	Sodium hypochlorite	○ Note 1, 2)	
	Cleaning liquids	—	
	Hydrochloric acid	×	
	Hydrofluoric acid	×	
	Sulfuric acid	×	
	Hydrogen peroxide concentration (5%)	○	
	Sodium hydroxide	×	
	Potassium hydroxide	×	
Ammonia (20%)	○		
Metal corrosive liquid	×		
Highly permeating liquid	×		
Highly penetrating liquid	×		

Note 1) Since static electricity may be generated, implement suitable countermeasures.

Note 2) These may be penetrated by fluids, and the penetrating fluids may affect parts of other materials.

### ⚠ Caution

#### Caution for transferring highly penetrating liquids

Do not use liquids which are highly penetrating to fluorine resin. This may cause internal damage to the process pump or liquid leakage.



# Series PB

## Specific Product Precautions 1

Be sure to read this before handling. Refer to back cover for Safety Instructions. Read the "Operation Manual" carefully before use to understand the outline of the product and issues relating to safety. The Operation Manual can be downloaded from the SMC website: <http://www.smcworld.com/>

### Design

#### Warning

##### 1. Check the specifications.

Give careful consideration to operating conditions such as the application, fluid and environment, and use the product within the operating ranges specified in this catalogue.

##### 2. Fluids

- For the compatibility between the materials composing the product and the fluids, check the compatibility check list. Since the compatibility of the fluid used may vary depending on its type, additives, concentration, temperature, etc., give sufficient consideration when selecting the material.
- For fluids other than those listed in the check list, please consult SMC. Also, use them within the range of the operating fluid temperatures.
- If foreign matter is mixed in the fluid, these may cause abrasion of the inside of the pump resulting in a problem. Use an appropriate filter (strainer) to remove them. In general, 80 to 100 mesh (150 to 180 μm) filters are recommended.
- When transferring a coagulable liquid, take measures to prevent it from coagulating in the pump.
- Flammable fluid cannot be used with the process pump with built-in solenoid valve (PB1011A). Do not use in an environment where flammable fumes are present or where flammable liquid may get stuck to the product.
- Take measures so that the pump body is not exposed to liquid.

##### 3. Water hammer

If a valve is operated abruptly etc., a high pressure may be applied due to water hammer. Take measures to prevent pressures higher than specified from being applied.

<Examples of measures>

- Use a water hammer resistant valve to reduce the valve closing speed.
- Use an elastic piping material such as rubber hose or an accumulator to absorb the impact pressure.

##### 4. Liquid seals

Provide a relief valve in the system to prevent it from becoming a liquid-sealed circuit.

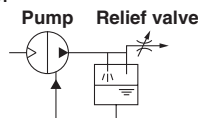

Countermeasures against liquid-sealed circuit

##### 5. Fluid pressure

Feeding the fluid from the suction side into the pump with pressure or drawing it with negative pressure will cause reverse pressure to be applied to the diaphragm, causing shortening of the product life.

##### 6. Ensure space for maintenance.

Secure the space required for maintenance and inspection. Take into consideration also leakage from the product. When transferring a flammable liquid or a liquid that may affect the human body or environment, take measures including fire ban and keeping the area off limits.

##### 7. Use a design which prevents reverse pressure and reverse flow.

If reverse pressure or flow occurs, this can cause equipment damage or malfunction, etc. Take safety measures in designing the circuit.

##### 8. Measures against static electricity

Take measures against static electricity as static electricity may occur depending on the fluid.

##### 9. The pump cannot transfer gas. Do not allow it to idle for a long time.

If the pump is operated for a long time without any fluid inside, the diaphragm may be damaged or the life may be shortened. Do not continue idling for 3 minutes or longer.

##### 10. Built-in solenoid valve

Refer to "Handling Precautions for SMC Products" (M-E03-3) for the usage of the solenoid valve.

##### 11. Condensation and freeze of the pilot port

The built-in solenoid valve type air exhaust port and air-operated type air supply port can be cooled down quickly due to expansion of the supply air, and this may cause condensation on the piping and the condensation may freeze during operation in winter. Take measures to ensure that water droplets from condensation are not splashed onto any electric parts or equipment.

### Piping

#### Caution

##### 1. Flush the piping.

Flush and clean the piping before connecting the product. Any dirt or scale and the like left in the piping may cause malfunction or failure.

##### 2. The port thread material of PB series is resin. Use a fitting with a resin thread for piping the fitting.

##### 3. Tighten screws with proper tightening torque.

When screwing fittings into the product, tighten them with proper tightening torque as shown below. Over-tightening can damage the thread.

##### Series PB1000A

Connection thread	Proper tightening torque (N·m)
Rc, NPT, G 1/8	0.8 to 1

##### Series PB1313A

Connection thread	Proper tightening torque (N·m)
Rc, NPT, G 1/8	1.5 to 2

### Air Supply

#### Warning

##### 1. Use clean air.

Do not use compressed air that includes chemicals, synthetic oils containing organic solvents, salinities or corrosive gases, etc., as it can cause damage or malfunction.

##### 2. Pay attention to avoid freezing when operating the product in low temperatures.

The equipment operates while expanding the compressed air. During this time, the temperature inside the product decreases due to adiabatic expansion. If the ambient temperature is low, using compressed air containing a lot of moisture may cause freezing because heat cannot be gained from the surroundings. In this case, take freeze prevention measures with a membrane air dryer (such as IDG series).

#### Caution

##### 1. Quality of pilot air

- Be sure to use only air filtrated by a micro mist separator (such as AMD series). Use of a super mist separator (such as AME series) is recommended to extend maintenance intervals.
- Use of humid air may cause condensation inside the body. Use air which has been treated by a refrigerated air dryer (such as IDF series).
- If a pump is operated by dried air and N<sub>2</sub> gas, etc., the deterioration of the inner gaskets will be accelerated and may result in substantially shortening of the product life.



# Series PB Specific Product Precautions 2

Be sure to read this before handling. Refer to back cover for Safety Instructions. Read the "Operation Manual" carefully before use to understand the outline of the product and issues relating to safety. The Operation Manual can be downloaded from the SMC website: <http://www.smcworld.com/>

## Operating Environment

### Warning

- Do not use in the following environments, as this can cause failure.**
  - Locations with an atmosphere of corrosive gases, organic solvents or chemical solutions, and where there may be contact with the same.
  - Locations where there is contact with sea spray, water or steam.
  - Locations where ultraviolet deterioration or overheating of resin may occur due to direct sunlight.
  - Locations near heat sources with poor ventilation. (Heat sources should be shielded by heat insulating material.)
  - Locations with impact or vibration.
  - Locations with excessive moisture or dust.
- The product cannot be used under water.**  
Do not use the product by immersing it in water (liquid). Otherwise, liquid will enter the openings inside the product, resulting in malfunction.
- Compressed air with low dew point**  
Using super dry air as the fluid may affect the reliability (service life) of the equipment, because the lubrication characteristics inside the

## Maintenance

### Warning

- Perform maintenance after consulting the operation manual.**  
Please obtain the operation manual for the equipment from SMC or our distributor, and have sufficient knowledge of the equipment before performing maintenance. Incorrect handling may cause damage or malfunction of the equipment or system.
- Perform maintenance after confirming the safety of the system.**  
Turn off the compressed air and power supply and exhaust any remaining compressed air in the system before removing the equipment and the compressed air supply/exhaust unit. Discharge the residual liquid or sufficiently displace it as necessary. Also, when reinstalling the equipment or restarting it after replacement, confirm the safety of the product before checking that it operates normally.
- Use appropriate protective equipment.**  
When touching the pump for maintenance, wear protective equipment such as gloves which are compatible with the fluid used.  
There is a risk of chemical burns.
- Do not disassemble the product, as disassembly will invalidate the product's warranty.**  
When disassembly is necessary, please consult with SMC or our distributor.
- When it is necessary to disassemble the product, the port set and the check valve set can be replaced with the part numbers below.**  
**Please obtain the maintenance procedure from SMC or our distributor, and read it carefully before carrying out maintenance.**  
**The product is not guaranteed once it has been disassembled. Customers are responsible for**

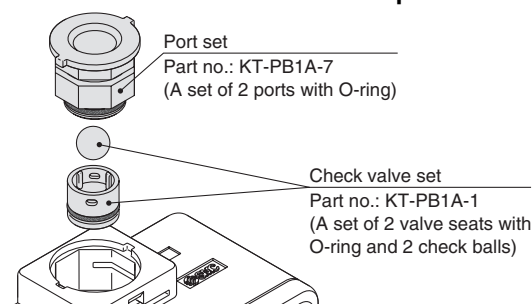

## Maintenance

### Caution

- Service life of diaphragm**
  - If the operating cycle of the process pump exceeds the service life of diaphragm, the diaphragm may be damaged due to deterioration. If it is damaged, the fluid will leak from the pilot air exhaust port and the air will blow out into the liquid circuit. Consider the pump operation (breathing, decline of discharge pressure, etc.) and the reference service life of diaphragm, and replace the pump as early as possible.

### [Calculation of reference service life (days) of diaphragm]

Calculate the service life (days) using the operating frequency of a solenoid valve.

Reference service life (days) =

A (reference number of cycles in service life)

Operating frequency of solenoid valve (Hz)

Model	Actuation	Diaphragm material	Amount of discharge per cycle	Reference number of cycles in service life A	Volume inside pump (wetted part)
PB1011A	Built-in solenoid valve	PTFE	Approx. 4 ml (Note)	30 million cycles	Approx. 9 ml
PB1013A	Air operated				
PB1313A			Approx. 3 ml (Note)	50 million cycles	Approx. 7 ml

Note) This is not a metering pump. The amount of discharge depends on the operating conditions.



## Handling

### Warning

- Test before using with the actual equipment.**  
Test the pump before using it with the actual equipment. Even if the test over a short period shows no problem, the seals that are in contact with the fluid may swell depending on the components of the fluid, causing malfunction.
- Storage**  
In the case of long-term storage after use, first thoroughly remove the liquid, and clean and dry the inside to prevent deterioration of the pump materials.
- After a long period of non-use, perform a trial run prior to operation.**
- Operating environment**  
When dangerous fluid is used, take measures to isolate humans from the pump. External leakage of transferred liquid could cause serious injury.
- External leakage of transferred liquid**  
There are some cases where the operating fluid will leak outside the pump, for example when the diaphragm reaches the end of its life. Depending on the operating fluid, take measures against external leakage, including installing a drain pan, to avoid adverse effects on humans and equipment.
- Caution for piping of the tube**  
Support the piping according to JIS B 8370 when piping the tube. Ensure that tensile force is not applied to the tube.

## Safety Instructions

These safety instructions are intended to prevent hazardous situations and/or equipment damage. These instructions indicate the level of potential hazard with the labels of “**Caution**,” “**Warning**” or “**Danger**.” They are all important notes for safety and must be followed in addition to International Standards (ISO/IEC)\*1), and other safety regulations.

-  **Caution:** **Caution** indicates a hazard with a low level of risk which, if not avoided, could result in minor or moderate injury.
-  **Warning:** **Warning** indicates a hazard with a medium level of risk which, if not avoided, could result in death or serious injury.
-  **Danger:** **Danger** indicates a hazard with a high level of risk which, if not avoided, will result in death or serious injury.

- \*1) ISO 4414: Pneumatic fluid power – General rules relating to systems.  
 ISO 4413: Hydraulic fluid power – General rules relating to systems.  
 IEC 60204-1: Safety of machinery – Electrical equipment of machines.  
 (Part 1: General requirements)  
 ISO 10218-1: Manipulating industrial robots - Safety.  
 etc.

### Warning

- 1. The compatibility of the product is the responsibility of the person who designs the equipment or decides its specifications.**  
 Since the product specified here is used under various operating conditions, its compatibility with specific equipment must be decided by the person who designs the equipment or decides its specifications based on necessary analysis and test results. The expected performance and safety assurance of the equipment will be the responsibility of the person who has determined its compatibility with the product. This person should also continuously review all specifications of the product referring to its latest catalogue information, with a view to giving due consideration to any possibility of equipment failure when configuring the equipment.
- 2. Only personnel with appropriate training should operate machinery and equipment.**  
 The product specified here may become unsafe if handled incorrectly. The assembly, operation and maintenance of machines or equipment including our products must be performed by an operator who is appropriately trained and experienced.
- 3. Do not service or attempt to remove product and machinery/equipment until safety is confirmed.**
  1. The inspection and maintenance of machinery/equipment should only be performed after measures to prevent falling or runaway of the driven objects have been confirmed.
  2. When the product is to be removed, confirm that the safety measures as mentioned above are implemented and the power from any appropriate source is cut, and read and understand the specific product precautions of all relevant products carefully.
  3. Before machinery/equipment is restarted, take measures to prevent unexpected operation and malfunction.
- 4. Contact SMC beforehand and take special consideration of safety measures if the product is to be used in any of the following conditions.**
  1. Conditions and environments outside of the given specifications, or use outdoors or in a place exposed to direct sunlight.
  2. Installation on equipment in conjunction with atomic energy, railways, air navigation, space, shipping, vehicles, military, medical treatment, combustion and recreation, or equipment in contact with food and beverages, emergency stop circuits, clutch and brake circuits in press applications, safety equipment or other applications unsuitable for the standard specifications described in the product catalogue.
  3. An application which could have negative effects on people, property, or animals requiring special safety analysis.
  4. Use in an interlock circuit, which requires the provision of double interlock for possible failure by using a mechanical protective function, and periodical checks to confirm proper operation.

### Caution

- 1. The product is provided for use in manufacturing industries.**  
 The product herein described is basically provided for peaceful use in manufacturing industries.  
 If considering using the product in other industries, consult SMC beforehand and exchange specifications or a contract if necessary.  
 If anything is unclear, contact your nearest sales branch.

## Limited warranty and Disclaimer/ Compliance Requirements

The product used is subject to the following “Limited warranty and Disclaimer” and “Compliance Requirements”.

Read and accept them before using the product.

### Limited warranty and Disclaimer

1. The warranty period of the product is 1 year in service or 1.5 years after the product is delivered.\*2)  
 Also, the product may have specified durability, running distance or replacement parts. Please consult your nearest sales branch.
2. For any failure or damage reported within the warranty period which is clearly our responsibility, a replacement product or necessary parts will be provided.  
 This limited warranty applies only to our product independently, and not to any other damage incurred due to the failure of the product.
3. Prior to using SMC products, please read and understand the warranty terms and disclaimers noted in the specified catalogue for the particular products.

\*2) Vacuum pads are excluded from this 1 year warranty.

A vacuum pad is a consumable part, so it is warranted for a year after it is delivered. Also, even within the warranty period, the wear of a product due to the use of the vacuum pad or failure due to the deterioration of rubber material are not covered by the limited warranty.

### Compliance Requirements

1. The use of SMC products with production equipment for the manufacture of weapons of mass destruction (WMD) or any other weapon is strictly prohibited.
2. The exports of SMC products or technology from one country to another are governed by the relevant security laws and regulations of the countries involved in the transaction. Prior to the shipment of a SMC product to another country, assure that all local rules governing that export are known and followed.

## Safety Instructions

Be sure to read “Handling Precautions for SMC Products” (M-E03-3) before using.

### SMC Corporation (Europe)

Austria	☎ +43 (0)2262622800	www.smc.at	office@smc.at
Belgium	☎ +32 (0)33551464	www.smc-pneumatics.be	info@smc-pneumatics.be
Bulgaria	☎ +359 (0)2807670	www.smc.bg	office@smc.bg
Croatia	☎ +385 (0)13707288	www.smc.hr	office@smc.hr
Czech Republic	☎ +420 541424611	www.smc.cz	office@smc.cz
Denmark	☎ +45 70252900	www.smc.dk.com	smc@smc.dk.com
Estonia	☎ +372 6510370	www.smc-pneumatics.ee	smc@smc-pneumatics.ee
Finland	☎ +358 207513513	www.smc.fi	smc.fi@smc.fi
France	☎ +33 (0)164761000	www.smc-france.fr	promotion@smc-france.fr
Germany	☎ +49 (0)61034020	www.smc-pneumatik.de	info@smc-pneumatik.de
Greece	☎ +30 210 2717265	www.smchellas.gr	sales@smchellas.gr
Hungary	☎ +36 23511390	www.smc.hu	office@smc.hu
Ireland	☎ +353 (0)14039000	www.smc-pneumatics.ie	sales@smc-pneumatics.ie
Italy	☎ +39 0292711	www.smcitalia.it	mailbox@smcitalia.it
Latvia	☎ +371 67817700	www.smc.lv	info@smc.lv

Lithuania	☎ +370 5 2308118	www.smclt.lt	info@smclt.lt
Netherlands	☎ +31 (0)205318888	www.smc-pneumatics.nl	info@smc-pneumatics.nl
Norway	☎ +47 67129020	www.smc-norge.no	post@smc-norge.no
Poland	☎ +48 (0)222119616	www.smc.pl	office@smc.pl
Portugal	☎ +351 226166570	www.smc.eu	postpt@smc.smces.es
Romania	☎ +40 213205111	www.smcromania.ro	smcromania@smcromania.ro
Russia	☎ +7 8127185445	www.smc-pneumatik.ru	info@smc-pneumatik.ru
Slovakia	☎ +421 (0)413213212	www.smc.sk	office@smc.sk
Slovenia	☎ +386 (0)73885412	www.smc.si	office@smc.si
Spain	☎ +34 945184100	www.smc.eu	post@smc.smces.es
Sweden	☎ +46 (0)86031200	www.smc.nu	post@smc.nu
Switzerland	☎ +41 (0)523963131	www.smc.ch	info@smc.ch
Turkey	☎ +90 212 489 0 440	www.smc-pneumatik.com.tr	info@smc-pneumatik.com.tr
UK	☎ +44 (0)845 121 5122	www.smc-pneumatics.co.uk	sales@smc-pneumatics.co.uk