

1 2 3 4 5 6

A

B

C

D

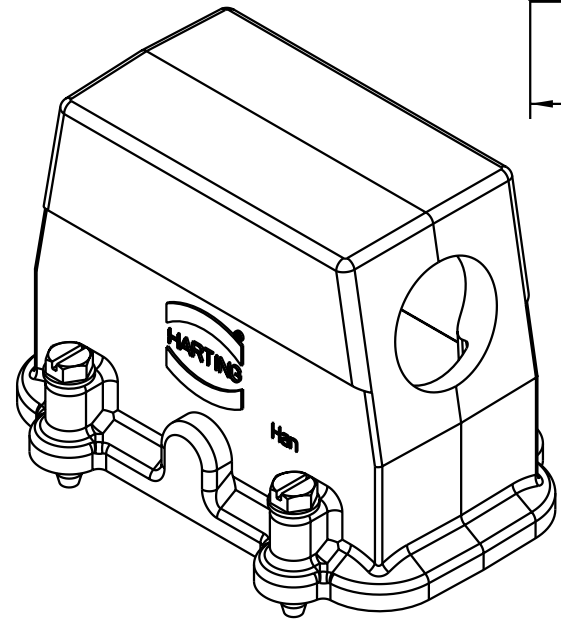
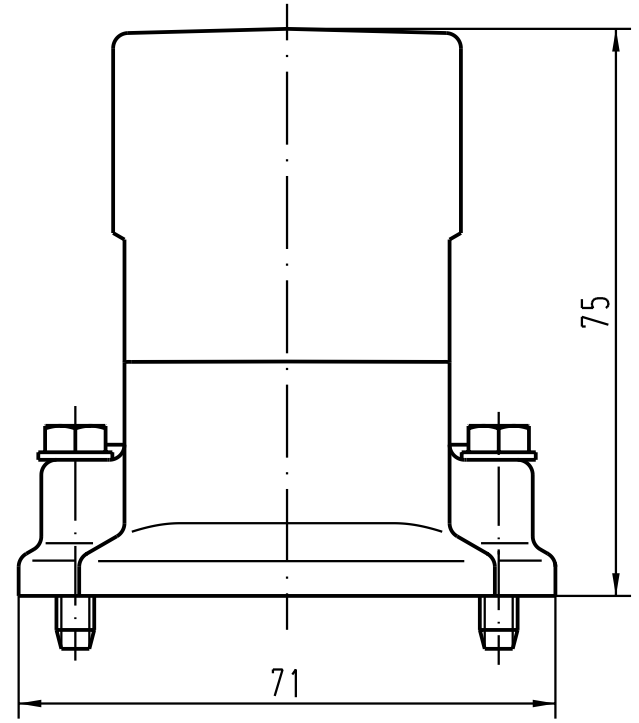
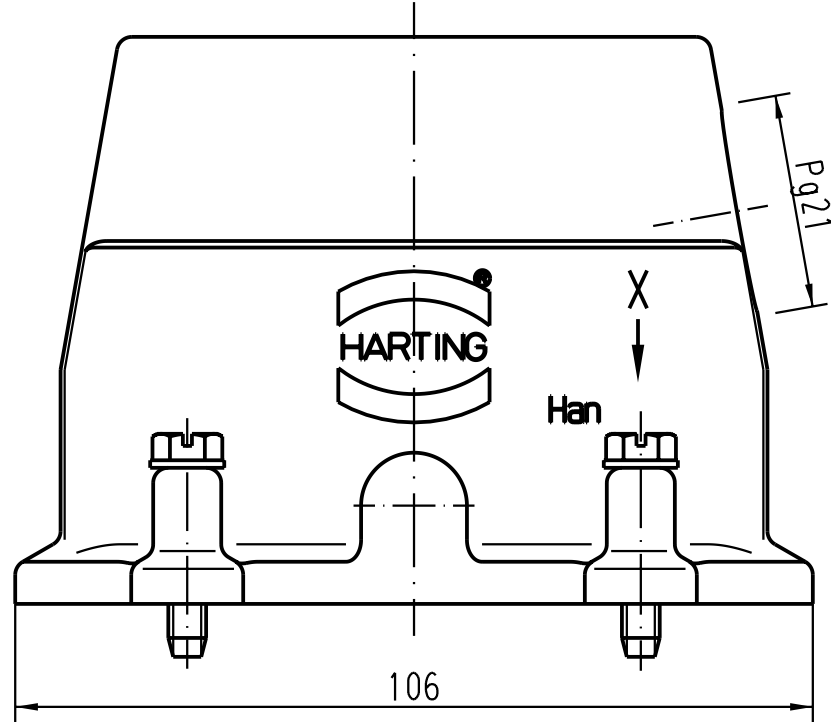
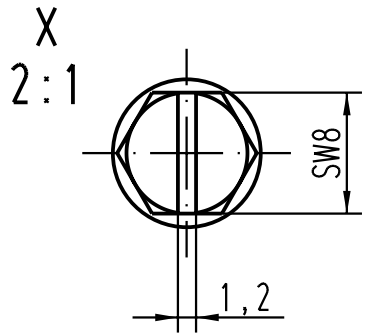

All Dimensions in mm Original Size DIN A 4		Techn. Character.			Nicht tolerierte Masse/ Free size tolerances		
			Dat.	Name	Massstab/Scale 1:1 2:1	Han 40EMV-gs-21 Tüllengehäuse/ hoods	
			Detail.	18.05.04			Loe.
			Insp.				KR
			Stand.				
411037			HARTING Electric GmbH & Co. KG D-32339 Espelkamp			TB 09 62 040 0540	
Mod.	Dat.	Name					Blatt/ page Sub. TB 09 62 0.. 054. v. 09.09.93